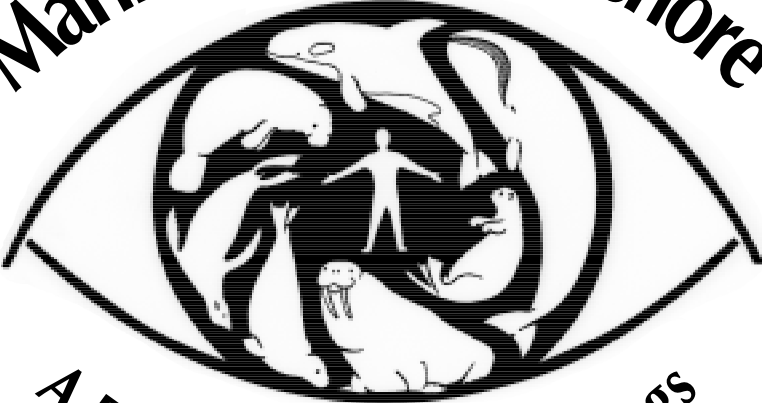


**Marine Mammals Ashore**



**A Field Guide for Strandings**

**Joseph R. Geraci • Valerie J. Lounsbury**

Sponsored by  
**National Oceanic and Atmospheric Ad-  
ministration**  
**National Marine Fisheries Service**  
**Office of Protected Resources**

With additional support from:  
Edgerton Research Laboratory of the New England Aquarium  
U.S. Marine Mammal Commission  
Alma Mater Fund of the Ontario Veterinary College  
NOAA National Sea Grant College Program

# **Marine Mammals Ashore**

## *A Field Guide for Strandings*

by  
**Joseph R. Geraci**  
and  
**Valerie J. Lounsbury**

A TEXAS A&M SEA GRANT PUBLICATION



Publication of this book is the result of a collaborative effort between the Texas A&M University Sea Grant College Program and the U.S. Department of Commerce's National Oceanic and Atmospheric Administration/National Marine Fisheries Service, pursuant to NOAA Sea Grant Award No. NA16RG0457-01. The views expressed herein are those of the authors and do not necessarily reflect the view of NOAA or any of its subagencies.

The illustrations that appear throughout the book are copyrighted by Joseph R. Geraci and Valerie J. Lounsbury, both of the University of Guelph, Guelph, Ontario, Canada, and are reproduced herein with the permission of the holders.

Copyright ©1993 Texas A&M University Sea Grant College Program.  
All rights reserved.  
Printed in the United States of America.

Book design by Amy Broussard

Texas A&M University Sea Grant College Program  
Publication TAMU-SG-93-601  
ISBN1-883550-01-7

For information on Texas A&M Sea Grant publications, contact:  
Sea Grant Program  
Texas A&M University  
P.O. Box 1675  
Galveston, Texas 77553-1675

## Foreword

When I came to the National Museum of Natural History in Washington in 1972, examination and collection of samples from stranded marine mammals was undertaken on a catch-as-catch-can basis. There were virtually no standards for any operations. That year witnessed the passage of the Marine Mammal Protection Act and signalled the start of major changes in scientific and public awareness of the problems marine mammals were facing. At the same time, legal statutes restricted access to stranded animals, and laid the groundwork for organized regional networks to oversee the collection of specimens and data.

In 1977, and again ten years later, workshops drew together members of those networks to share experiences and reinforce the call for detailed and standardized investigation of strandings. Still, workers in the field had no ready source of information on what to collect and how to do it. We have all been frustrated at one time or another to find important data missing from a stranding record, or searched in vain for voucher specimens to confirm the identity of a rare animal. And it is clear that without information on age, sex and reproductive status, tissue samples for toxicological analysis are almost useless. The protocols described in this manual are designed to ensure that the efforts of those investigating strandings result in the maximum gain for marine mammal science.

So much of the life history of marine mammals has been learned through the perseverance of loyal members of stranding networks. I am pleased to see this reference book that brings the knowledge to become a productive member of any stranding team within everyone's reach.

*James G. Mead  
Curator, Marine Mammals  
National Museum of Natural History  
Smithsonian Institution*

\* \* \* \* \*

For the general public, marine mammals are one of the most conspicuous components of marine biological diversity. Any that come ashore dead or ill raise the level of uneasiness about the health of our oceans. This has been particularly true over the past decade, when the incidence of large-scale die-offs of seals, dolphins and other species seems to have accelerated. However disturbing these events, stranded specimens provide a rare opportunity to learn about marine mammal biology, illness and mortality. Data and specimens gathered carefully over time continue to provide biological information on known species, and, indeed, new species are still being described.

However, knowledge arising from marine mammals washed ashore grows in small increments. Every piece of information must be obtained in a standardized, systematic way for the records to be dependable over the long term. Such

consistency is difficult to achieve and requires protocols. Dedicated volunteers, students and newcomers to marine mammal stranding networks are a godsend for assistance with data collection during these events, and often are the only ones available to deal with strandings on short notice. However, even for those with advanced training in biology, there is no established coursework to prepare them for this task; expertise is gained slowly through hands-on experience. Without a mentor, novices can be rightfully overwhelmed by their first encounter with a large, ripening beach-cast carcass, a gathering crowd, an incoming tide and looming nightfall.

Although there is no formal coursework, there is now a textbook! This field guide is a splendid contribution, and is easy to read and follow. The contents span topics such as organization of response teams, legal and regulatory requirements, identification and natural history, anatomy, handling and sampling protocols, safety, and public relations. Having access to this reference in their field kits will give the psychological and technical muscle new participants will need to carry out their work. Although written from a North American perspective, the guide will be an exceptionally valuable resource for non-specialists who work in remote regions without access to stranding networks or experienced senior personnel. The faithful application of techniques described herein can lead to the accumulation of meaningful knowledge on marine mammals in all parts of the world. This opens significant doors, because the greater the rate at which we learn about marine mammal biology, the greater the possibilities for averting future crises for this vital component of biological diversity along our shorelines.

*Thomas J. O'Shea  
Assistant Director  
National Ecology Research Center  
U.S. Fish and Wildlife Service*

## **A Personal Note to the Reader**

Marine mammals have foundered ashore over the ages, for reasons that are now becoming understood—and popularized. Anyone exposed to the daily media is aware that a lone seal pup howling on the beach or a whale thrashing too close to shore or a manatee stuck in a culvert needs help. For those who wish to lend a hand, there are numerous ways to find out when to act, how to proceed, expected outcomes, and the value of getting involved in the first place. For direction one can turn to scientific and popular writings, burgeoning files from stranding centers, and the wisdom of veteran rescuers. The material is not easy to obtain and is about as varied as a beachcomber's cache.

The National Marine Fisheries Service, the agency responsible for protecting and managing most of the nation's marine mammals, saw the need to analyze and condense this information into a practical manual to serve its nationwide marine mammal stranding network. Thus arose this Field Guide.

It is intended for the person planning to become involved, and for those already active in stranding programs who would benefit from knowing what others have learned. Chapters on Historical Perspectives and Organization show that what one can accomplish alone, an organized team can do faster, safer and with better results. The book takes the reader through a spectrum of options for dealing with stranded animals of each major group (pinnipeds, cetaceans, manatees, sea otters), from the first approach on the beach, to immediate release and rehabilitation, to euthanasia for those beyond hope. A comprehensive plan is offered for gathering scientifically valuable specimens and data from animals living or dead. Throughout, we take into account the right of the public to witness and become involved in stranding operations, using each event as an educational opportunity.

Some topics are touched upon briefly. Although the text describes clinical techniques, medical conditions demanding emergency care, and ways to transport animals, we deliberately avoid any attempt to teach procedures that must be left to qualified personnel. The sections on rehabilitation present only an overview of basic husbandry programs. It is written less for the care-giver than for the person on the beach who wishes and perhaps needs to know what happens once the animal is taken to a facility. Such topics as life history and mortality have been written concisely, with emphasis on natural and human-related processes that play a role in stranding events.

We wrote this book from a U.S. perspective, while recognizing that marine mammal movements and habitats are not limited by national boundaries. We would like to have included all of North America but were limited by available literature and other sources of data from adjacent countries. Coverage is thus somewhat thin, for example, on Baja California and the Gulf of California, while eastern Mexico and most of the Canadian Arctic are excluded. Any bias toward New England can probably be traced to Salisbury Beach and Plum Island at the mouth of the Merrimac River, where the authors JRG and VJL (strangers then) respectively spent their childhood days.

We probed the literature, used our own experiences, and sought advice from more than 50 colleagues from eight countries to help identify approaches and action plans that work. Our choice of reference material was ultimately restricted by the book's small format. We therefore offer as many review articles and general works as possible, with more specialized publications used selectively. The bibliography should provide at least a starting point for anyone wishing to pursue a topic in more depth.

The format of this book is our own and we are entirely responsible for its factual content. We ask the reader to bring any inaccuracies or shortcomings to our attention, and to offer suggestions on how the next edition might be improved.

We hope this Field Guide offers some useful and enjoyable reading in the office or the lab. But it will earn its salt as a reliable companion if it helps to rescue a distressed animal, or enables us to learn more about environmental circumstances and behavioral and medical conditions that force marine mammals from their world into ours.

*Joseph R. Geraci*  
*Valerie J. Lounsbury*



## Acknowledgements

This book grew from a commitment by **Nancy Foster** of the National Marine Fisheries Service (NMFS), Office of Protected Resources, to streamline the collection of marine mammal tissues for the National Institute of Standards and Technology's (NIST) National Tissue Bank, and took shape with the indispensable help of friends and colleagues with a wide range of expertise.

**James Mead** provided data from the Smithsonian Institution's (Washington, D.C.) Marine Mammal Events Program, **Jon Lien** (Memorial University, St. John's, Newfoundland), **John Parsons** (Nova Scotia Stranding Network), **Lloyd Lowry** (Alaska Department of Fish and Game), and **Francis Fay** (University of Alaska) offered information on stranding patterns from areas where published data are sparse. **Dean Wilkinson's** (NMFS) review and knowledge of marine mammal stranding programs in the U.S. were essential to our chapter on organizing networks. **Greg Early** of the New England Aquarium (NEA), Boston, Mass., gave freely of his insights and experiences. All are valuable; some he has offered in the hopes that others won't make the same mistakes.

For their various contributions in the preparation of background material, we are indebted to **Padraig Duignan, Michael Geraci, Elissa Kuecks, Carl Porter, Gary Smith**, and **Brian Wilcock** from the Department of Pathology at the University of Guelph, Guelph, Ontario, and **John Lynch** of the Ontario Ministry of Agriculture and Food. **Sentiel Rommel** (Marine Mammal Program, Smithsonian Institution) reviewed illustrations based on his anatomical drawings of the bottlenose dolphin, harbor seal and California sea lion.

**David St. Aubin** (University of Guelph) contributed his broad knowledge, experience, editing skills and continued encouragement. As always, he was indispensable. **Stephen Wise** (NIST) helped consolidate the proposal and funding arrangements that made the book possible. **Ted Lillestolen**, National Marine Fisheries Service Office of Protected Resources, galvanized the project from its conception to its publication, solving every imaginable problem along the way. We thank **Victor Omelczenko** of NOAA's National Sea Grant Office and **Amy Broussard** of the Texas A&M University Sea Grant College Program for providing more than they had bargained for in the design and production of the book. And for helping with the preparation of the manuscript, figures and appendices, as well as keeping everything and everyone organized, we are particularly grateful to **Heather Copland** (University of Guelph).

The strength of this work...both its narrative and accompanying illustrations...owes much to our Panel of Reviewers. The entire manuscript was reviewed by: **Andrea Conley** and **Greg Early**, New England Aquarium; **Thomas Hulland**, University of Guelph; **James Mead**, Smithsonian Institution; **Thomas and Sally Murphy**, South Carolina Wildlife and Marine Resources Department, Charleston, S.C.; **David Obendorf**, Tasmania Department of Primary Industry and Fisheries, King Meadow, Tasmania; and **Frank Roylance**, *The Baltimore Sun*, Baltimore, Md. We are grateful to James Mead for his scrutiny of the cetacean species illustrations.

Individual chapters were reviewed by: **Daniel Baden**, Rosenstiel School of Marine and Atmospheric Sciences, University of Miami (Ch. 10); **Peigin Barrett** and **Laurie Gage**, Marine Mammal Center, Sausalito, Calif. *also* **Lance Morgan**, **Krista Hanni**, **Dawn Smith** (Ch. 4, 5, 13); **Anne Baker**, Infectious Disease Unit, Massachusetts General Hospital, Boston (Ch. 12); **Brian Beck**, Bedford Institute of Oceanographic Research, Halifax, Nova Scotia (Ch. 10); **Peter Best**, University of Pretoria, South Africa (Ch. 6, 11); **Robert Bonde**, U.S. Fish and Wildlife Service, National Ecology Center, Gainesville, Fla. (Ch. 8, 11); **Gregory Bossart**, Miami Seaquarium (Ch. 8); **Robert Brownell**, U.S. State Department, Washington, D.C. (Ch. 11); **Deke Buesse**, Oviedo, Fla. (Ch. 8); **Martin Cawthorn**, Wellington, New Zealand (Ch. 6); **Elizabeth Dolgoff**, National Aquarium in Baltimore (Ch. 3); **Francis Fay**, Institute of Marine Science, University of Alaska Fairbanks (Ch. 5); **Nicholas Gales**, Underwater World, Perth, Western Australia (Ch. 6, 7); **Sylvia Gallaway**, NMFS, Living Marine Resources Management, Charleston, S.C. (Ch. 10); **Michael Gosliner**, Marine Mammal Commission, Washington, D.C. (Ch. 11); **Günter Heidemann**-Institut Für Haustierkunde, Der Christian-Albrechts-Universität, Kiel, Germany (Ch. 5); **John Heyning**, Natural History Museum of Los Angeles County (Ch. 11); **Ronald Jameson**, U.S. Fish and Wildlife Service, National Ecology Center, San Simeon, Calif. (Ch. 9); **Barbara Koster**, NIST, Organic Analytical Research Division, Gaithersburg, Md. (Ch. 10); **Kathy Krieger**, NEA (Ch. 5, 6, 7); **Lloyd Lowry**, Alaska Department of Fish and Game, Fairbanks (Ch. 5, 6); **Helene Marsh**, Environmental Studies, James Cook University of North Queensland, Australia (Ch. 11); **James McBain**, Sea World, Inc., San Diego (Ch. 9); **Thomas McIntyre**, NMFS, Office of Protected Resources, Silver Spring, Md. (Ch. 11); **William Medway**, School of Veterinary Medicine, University of Pennsylvania, Philadelphia, Penn. (Ch. 12); **Daniel Odell**, Sea World, Inc., Orlando, Fla. (Ch. 4, 7, 8, 11, 13); **Thomas O'Shea**, U.S. Fish and Wildlife Service, National Ecology Center, Ft. Collins, Colo. (Ch. 8, 9, 10); **William Perrin**, NMFS, Southwest Region, La Jolla, Calif. (Ch. 6, 11); **Sam Ridgway**, Naval Ocean Systems Center, San Diego (Ch. 5, 6, 11, 12); **Ian Robinson**, RSPCA, Norfolk Wildlife Hospital, King's Lynn, Norfolk, U.K. (Ch. 5); **Thomas Smith**, Canada Department of Fisheries and Oceans, Pacific Biological Station, Nanaimo, British Columbia (Ch. 1, 5, 11); **John Twiss**, Marine Mammal Commission, Washington, D.C. (Ch. 11); **Michael Walsh**, Sea World, Inc., Orlando, Fla. (Ch. 6, 7, 8); **Dean Wilkinson**, NMFS, Office of Protected Resources, Silver Spring, Md. (Ch. 1, 10); **Thomas Williams**, Monterey Bay Aquarium, Monterey, Calif. (Ch. 9); **Stephen Wise**, NIST, Organic Analytical Research Division, Gaithersburg, Md. (Ch. 10); and **Amy Woodworth**, National Aquarium in Baltimore (Ch. 3).

## Table of Contents

Foreword .....	iii
A Personal Note to the Reader .....	v
Acknowledgements .....	vii
Dedication .....	xi
<b>Chapters</b>	
1 Perspectives on Strandings and Response Programs.....	1
2 Getting Organized .....	7
3 Public Support and Media Relations .....	19
4 Decisions on the Beach.....	27
5 Pinnipeds.....	35
6 Cetaceans—Single Strandings .....	71
7 Cetaceans—Mass Strandings .....	133
8 Manatees.....	145
9 Sea Otters .....	159
10 Specimen and Data Collection .....	175
11 Carcass Disposal .....	229
12 Health and Safety Risks .....	239
13 The Follow-Up .....	245
References .....	249
<b>Appendices</b>	
A: Suggested Field Equipment .....	291
B: Sample Necropsy Report Form.....	294
C: Sample Telephone Directory for Strandings .....	299
Subject Index .....	301
Species Index.....	305
About the Authors .....	309



*Two men have, in countless ways, influenced the writing of this book. Sadly, one of them, Forrest G. Wood, did not live to see the final version. He was a pioneer of marine mammal science, a poet, and a defender of the English language. The other, William E. Schevill, scholar, mentor and friend, continues to provide the wisdom, inspiration and guidance that keep the rest of us from stranding.*

*Chapter 1*  
**Perspectives on Strandings  
and Response Programs**

1.1. Animals .....	1
1.2. Defining a Stranded Animal .....	2
1.3. Of What Interest Is a Stranded Animal?.....	3
1.4. Development of Stranding Response Programs .....	5
References .....	249

**1.1. Animals**

Early in the evolution of mammals, a variety of forms began to explore the sea as an alternative to living on land. Many of those attempts were unsuccessful, and some varieties came and went without making a lasting mark. Others—muskrats, otters and seals—have partially adapted, while still preserving vital ties to the shore. The cetaceans (whales and dolphins) and sirenians (manatees and dugongs) alone are completely and only at home in water.

Adjusting to the marine environment required the modification of numerous body systems. The proficient divers—pinnipeds and cetaceans—demonstrate a host of **anatomic and physiologic adaptations** for efficiently acquiring, storing and utilizing oxygen. Some of the more apparent features are:

- lungs made firm and “springy” by small coils of cartilage that encircle the airways throughout, permitting the lungs to virtually snap open after a dive
- a large volume of blood that is quite dark owing to its rich supply of oxygen-carrying hemoglobin
- an expansive circulatory system with intriguing reservoirs (thoracic rete in cetaceans, hepatic venous sinus in pinnipeds) for storing blood until it is needed, or for re-routing it elsewhere
- muscles that are dark, often nearly black with myoglobin, a pigment that can store extra oxygen for release during long dives

For overall thermal protection, otters and fur seals depend on a blanket of thick fur. Cetaceans and other pinnipeds rely instead on blubber, a tissue that is mostly fat. By regulating blood circulation, a marine mammal is able to deal with extreme variations in temperature when swimming from the surface to the bottom or from one region to another.

Blubber has other important roles besides providing insulation. The tissue is buoyant and enables the animal to remain at the surface to breathe and rest there without effort. Marine mammals drink little sea water and draw most of their fresh water from food. During fasting, or when prey is scarce, fat from the blubber is released for energy, and, like that in a camel's hump, produces crucial fresh water as a by-product. To endow her newborn with precious blubber, a mother hooded seal will transfer enough fat-rich milk to the pup for it to double its body weight within four days of birth (an average gain of 6.5 kg/day), while losing about 30 kg of blubber herself<sup>3</sup>.

As vital, but less obvious, are the adaptations for coping with the demanding nature of the saltwater environment itself. The skin of all marine mammals is impervious to sea water. To achieve this impenetrable state, the epidermis of cetaceans employs extraordinary cells tightly woven into an architecture that is unique among mammals. The adrenal gland's response to stress both in cetaceans and pinnipeds also serves to protect the animals from surrounding sea water. Aldosterone released from the adrenal cortex causes the animal to retain its own salt and water, freeing it from the need to drink any quantity of sea water. By this mechanism, an animal in stress becomes physiologically isolated from the external environment.

These adaptations enable an otter, for example, to keep warm in icy waters, a baleen whale to migrate thousands of kilometers over several months while fasting, a sperm whale to breath-hold for hour-long dives to 2,000 meters or more, and a seal pup to begin life with energy reserves in place. On the other hand, failure of a system can jeopardize the tenuous shield protecting the animal from its environment. An animal that cannot eat for whatever reason becomes thin. With less blubber, it must work harder simply to stay afloat and keep warm, thereby burning more energy that depletes more fat—its only remaining source of nourishment and water. The life-draining spiral tightens rapidly, and its effect can be seen in animals that come ashore to strand. Many are emaciated, dehydrated, and exhausted.

## 1.2. Defining a Stranded Animal

A "strand" is a beach, or land bordering a body of water, and **stranded** is defined as having run aground. The latter term also describes any creature having been left in a helpless position, such as a marine mammal that falters ashore ill, weak, or simply lost. The expression **mass-stranded**, while not so enshrined in convention, generally refers

to a simultaneous stranding of two or more cetaceans other than a female and her calf<sup>29</sup>.

**Mass die-off** refers to mortality on a large scale. The term does not describe the cause of death, the number of species involved, nor whether any animals came ashore, but merely the outcome. Mass die-offs have resulted from rapidly spreading viruses such as influenza<sup>7</sup> and phocine distemper<sup>12,14,20,27</sup>, parasitic infection<sup>15</sup>, and long-term ingestion of algal toxins<sup>9</sup>. Each of these events has brought hundreds or thousands of animals ashore, but none in the manner that could be called a “mass stranding”.

Since shore is not the only place where a marine mammal is helpless, a **stranding** is routinely defined as an animal that cannot cope in its present situation or—borrowing from aviation vocabulary—one that is outside its survival envelope. That includes an arctic seal in Florida waters, a manatee immobilized after a vessel strike, an ice-bound gray whale, orphaned dependent offspring, a dolphin swimming aimlessly, or an otter drenched with oil. This enlarged concept of stranding calls for help as a preventive measure and highlights the quandary of deciding when to act.

Some writers distinguish between strandings and **beachings**, the latter referring to animals cast ashore already dead. For scientific purposes it is useful to adopt that distinction when it can be made, that is, when the animal's condition on arrival is known. Otherwise, the common tendency is to use “stranded” for any live or dead specimen<sup>13,18</sup>.

### 1.3. Of What Interest Is a Stranded Animal?

History is full of references to beached marine mammals. In pre-historic New England and on the Pacific coast, carcasses were used for food and featured prominently in Indian mythology. Maushop, the legendary giant who was said to live on the Massachusetts island of Martha's Vineyard, fished for whales. Those he didn't eat, he cast ashore to share with his friends. Pilgrims later proposed to name what is now Wellfleet Bay on Cape Cod “Grampus Bay” (“grampus” was a common term for “dolphin”) because of the frequency of strandings there. Some of the first laws enacted in the New England colonies were to establish the ownership of beached whale carcasses.

As the shore developed into a fashionable dwelling place, the occurrence of a seal or whale on a beach must have been a curiosity at best, and at worst a nuisance. But they had value, too. Strandings furnished



some of the first cetaceans for live displays<sup>16</sup> and were a source of specimens for museum exhibits and curios for coastal dwellers. Adorning our laboratory is a handsome walrus skull from the relict East Coast population, dredged not from the ocean floor, but from a bushel of acorn squash in a small village store in Quebec's Iles de la Madeleine.

So evident was the **scientific potential of stranded animals**, that Frederick True, noted cetologist and one of the first curators of the **National Museum of Natural History (Smithsonian Institution)** organized a marine mammal stranding program along the East Coast more than a century ago<sup>19</sup>. Through successive marine mammalogists, and particularly since 1972 under the guidance of Marine Mammal Curator James Mead, the Smithsonian is now regarded not only for its traditional collection of marine mammal skulls and skeletons, but also for its archive of photographs, measurements, stomach contents, reproductive organs, teeth for age determination, samples for toxicologic analysis and genetic studies, parasites, and even samples of diseased tissues.

Such efforts worldwide have been rewarded. The existence of some marine mammal species is known only from strandings. Details accumulated over the years have furnished pictures of growth rates, age at maturity, gestation period, birth intervals, reproductive season, and longevity of numerous species<sup>17,26</sup>. We have learned about individual illnesses and wholesale mortalities caused by viruses, bacteria, parasites, and algal toxins<sup>4,8,10,12,21</sup>, and the types, amount, geographic sources, and trends in the levels of oceanic contaminants<sup>1,5,6,25</sup>.

How this scientific information relates to **conservation measures** and policy depends on the species. The animals that strand most commonly are generally those that are most abundant, and for that reason, "rehabilitating" a harbor seal in New England or a California sea lion for eventual release will not likely benefit either population in any way. In fact, releasing one carrying infectious organisms is apt to be harmful. The rescue of an endangered monk seal is another matter; every addition will have a measurable effect on the very small population. Still, only time may tell whether reintroducing any creature that was "weeded out" in the first place is, in the long term, beneficial to the wild population.

The average person today would not respond to a stranding merely because the animal has some scientific value. If collecting scientific information were the only motivation, the next harbor seal to stagger onto a beach would probably be left abandoned. More often, we are

moved by the **humane need to help an animal in distress**. Beyond that, marine mammals have taken on a new role that is reflected in the way we view them and how we react when any one of them comes ashore. Manatees crippled by boats are a steady reminder of how we indulge our recreational activities at the expense of wildlife. Otters killed by oil expose the growing ambivalence between our desire to protect fragile coastal ecosystems and our demands on industry to exploit these areas for economic benefit. Any mass stranding of whales is certain to rekindle arguments over the possible role of pollutants, of which the ocean has plenty. Marine mammals, it seems, have become a totem of our battle for a fresh, clean environment. We search the beaches for evidence of casualties and find stranded animals. We can only speculate on how many are victims of our excesses, but each and every one of them helps us keep the vigil.

#### 1.4. Development of Stranding Response Programs

The vast body of literature on strandings consists mostly of reports of single animals. Earlier accounts, though valuable for their detail, were not integrated into any overall scheme that gave an accurate reflection of stranding patterns and distribution. **To be truly valuable, data have to be collected in a consistent way, on the greatest possible number of specimens, and over a long period of time.** Only then can the information contribute to an understanding of the size, shifts or movements in a population, and factors underlying natural mortality. A unified plan was needed to collect this kind of information.

The **Marine Mammal Protection Act of 1972** gave the federal government jurisdiction over marine mammals in the United States. By protecting them from capture or harassment, and prohibiting the taking of parts from carcasses except by those specifically authorized to do so, the Act was a driving force to organize formal regional stranding response networks.

Initially, scientists working with stranded animals were required to obtain a research permit. But such a requirement was unworkable and meant that research opportunities were missed. Because of these concerns, the **U.S. Marine Mammal Commission** sponsored a workshop in 1977, in Athens, Georgia, at which 42 scientists from 19 states, Canada and England met to discuss marine mammal strandings. The presentations covered every conceivable topic and generated lively debate on a range of issues that ultimately led to 10 recommendations<sup>1</sup>. One recommendation was to establish the framework for a **National**

**Stranding Alert Network** with regional centers and a central data file, coordinated by the **National Marine Fisheries Service (NMFS)**.

The workshop served as a springboard for the formation of a national stranding plan in the United States. Centers have been organized within each of the NMFS administrative regions; data are being compiled—regionally by member institutions and state agencies, and nationally by the **NMFS, Fish and Wildlife Service (FWS)** and the **Smithsonian Institution**. The integration of these activities made it possible for the **National Institute of Standards and Technology (NIST)** to establish an archive for tissues from stranded animals.

The Second Marine Mammal Stranding Workshop, held in Miami, Florida, in 1987<sup>22</sup>, reviewed the history and achievements of the national plan, region by region, and consolidated a scheme for collecting and archiving data. The range of scientific presentations highlighted the value of using stranded animals to advance our understanding of marine mammal biology from the population to the cellular and molecular level.

The decade of the 1980s witnessed the expansion of organized stranding programs in other countries as well. From Australia came the “Victorian Whale Rescue Plan”<sup>28</sup>, the first step-by-step approach to organizing a civic stranding response. A 1983 workshop on strandings sponsored by the Royal Society for the Prevention of Cruelty to Animals (RSPCA) produced a brief account of first-aid for cetaceans on the beach<sup>24</sup>. Another manual was prepared in New Zealand for training personnel in marine mammal rescue<sup>2</sup>. The richest popular document of the decade was Frank Robson’s book ***Strandings: Ways to Save Whales***<sup>23</sup>. It is a splendidly detailed narrative of a retired fisherman’s life-long devotion and personal investment in a field few others knew, or cared much about. Scientific scrutiny aside, everyone will profit from reading it.

It is unlikely that any new stranding plan can be developed without borrowing extensively from previous thought and experience. Wilkinsor<sup>29</sup>, in a review of marine mammal stranding networks in the United States, analyzed past and current operations, identified strengths and weaknesses within each, and offered recommendations for overall improvement. Response networks will thus continue to evolve. The goals, however, seem already well established:

- Provide for the **welfare of live animals**.
- Minimize risk to **public health and safety**.
- Support **scientific investigation**.
- Advance **public education**.



*Chapter 2*  
**Getting Organized**

2.1. The Stranding Network.....	7
2.2. Regulatory Authority .....	7
2.3. The Operations Center .....	9
2.4. The Response Team .....	10
2.5. Logistic Support .....	13
2.6. A Model Response.....	14

**2.1. The Stranding Network**

The **objectives** of a stranding network are:

- to provide rapid and effective action that will best serve the well-being of the stranded animal(s)
- to protect the public while acting on its concern
- to gain maximum scientific information

**Essential elements** of a network include an emergency response team with a veterinary component; logistic support and equipment for moving animals; a facility for medical treatment and rehabilitation; and a complement of scientists able to collect, analyze, and archive specimens and data. To function as a unit, the network requires formal training programs and practice drills, uniform protocols, and a spirit of group effort maintained through solid lines of communication.

Stranding networks in the U.S. are nominally based on the **administrative regions of the National Marine Fisheries Service (NMFS)** For the purposes of this field guide, it is more practical to establish **zoogeographic zones based on species distribution and stranding records** (Fig. 2.1). This scheme disregards state or national boundaries, as well as regions established by NMFS, but will help to predict the types of activity one may expect in a particular area (see **5.3, 5.12, 6.3, 6.13**).

**2.2. Regulatory Authority**

The network must function within the legal framework established by various federal, state and regional authorities, and cooperate with them to ensure effective action and long-term goals. The **U.S. Marine Mammal Protection Act** specifically prohibits the collection of animals (live or dead) or parts from them, or any form of harassment, detention or restraint, however temporary. Exceptions are permitted for government officials acting in the course of their duties, and for other authorized



**Fig. 2.1.** U.S. National Marine Fisheries Service Stranding Network jurisdictions compared to regions based on marine mammal distribution in U.S. and adjacent waters. Areas 3 and 8, notably smaller than the others, are transition zones between generally differing northern and southern fauna. The few strandings that do occur in these zones may be of animals from either of the adjacent regions.

individuals, when the action is essential to protect the animal's or the public's welfare.

It is clear that a person wanting to help an animal on the beach must first obtain permission. One approach is for an individual or organization to apply to **NMFS** for a **letter of authorization**, which will allow work with cetaceans and all pinnipeds except the walrus. Walruses, sea otters and manatees are under the jurisdiction of the **U.S. Fish and Wildlife Service**, which must authorize any work involving these species. A more common way to become involved is to associate with persons or

institutions already authorized as members of marine mammal stranding networks.

Many coastal states have enforcement officers with statewide (Marine Patrol, Fish and Game personnel) or local (park rangers) jurisdiction. The geographic limits and laws governing these jurisdictions must be respected by network members. In some areas, state law enforcement officers may be under formal contract with the regulating federal agency to assist in strandings.

Local **police** are invaluable participants in a stranding response. They have legal authority over all activities on the beach and can maintain order and protect animals by limiting access to the site, erecting barriers if necessary, and controlling crowds and vehicles. Police must supervise the use of firearms and may agree to oversee the distribution of controlled substances such as anesthetics and euthanasia solutions. During mass strandings, a representative of the Law Enforcement Branch of NMFS may assist local police in support of network activities. Harbormasters and animal control officers may render additional assistance.


The **Coast Guard's** obligatory role in a stranding is limited to situations involving risk to human life or hazards to navigation. They have excellent equipment and trained personnel and often go far beyond their duties to provide valuable support in transporting team members to remote stranding sites, providing foul-weather gear, and hauling beached carcasses to sea.

### 2.3. The Operations Center

Each NMFS region has a stranding coordinator and at least one stranding Operations Center, served by satellite units that might include aquariums, dedicated stranding facilities, research stations, museums, and state departments of wildlife or conservation.

The basic role of the Operations Center is to provide a **continually monitored telephone service** for receiving and verifying stranding reports and to coordinate the response. Those organizations of potential benefit to the stranding network (police, Coast Guard, municipal authorities, centers for education and research, wildlife and conservation groups) should be informed of the Center's existence. The Operations Center should also:

- organize and administer the regional network
- train staff and volunteers

- 
- notify and work with federal and local authorities
  - maintain a communications link among all network elements
  - promote public awareness of the network's activities
  - coordinate the response from the Center or closest satellite
  - gather and archive data
  - report findings to the appropriate government agency
  - keep track of samples dispersed to authorized individuals

The Center's effectiveness hinges on **local resources and attitudes**, which will vary seasonally and among communities. It is unrealistic to expect an enthusiastic response on all holidays or during foul weather. Local officials must be presented with a strong plan of action and the reasons behind it. Otherwise, the townsfolk may be tempted simply to push a live animal out to sea, in hopes that if it does re-strand, it will be somewhere else.

The Operations Center should maintain current files on the capabilities of each coastal community within the region—physicians or hospitals in the vicinity (for emergency care of staff), beach conditions and obstacles likely to impede or influence the safety of the rescuers—and plan responses accordingly. Personnel must be aware of ordinances regulating such activities as carcass dissection (on the beach), disposal, and transport across town or state lines.

Except in areas where the coastline is continuously monitored by wildlife agencies, strandings are usually reported by the public. Each town may have its delegated or volunteer contact person, perhaps the animal control or conservation officer, harbormaster, or others with a particular interest. Once familiarized with the network's program, these liaisons can expedite the stranding response, while keeping the community informed.

## 2.4. The Response Team

### Responsibilities

The composition of a response team depends on the type and frequency of animals coming ashore in the region. Different strategies are required for oiled sea otters, traumatized manatees and mass-stranded pilot whales. Common to all situations, however, is the basic need for the team to:

- respond rapidly
- contact local authorities upon arrival

- evaluate the situation
- provide emergency care
- arrange to take action (release, transport, necropsy, specimen and data collection, and photographic documentation)
- enlist local assistance
- provide information to the public and media
- protect public health and ensure safety
- maintain a communications link with the Operations Center

### **Recruiting**

The core team requires a wide range of expertise. Apart from the obvious priorities (rescue, first aid, euthanasia, necropsy, etc.) is the need to organize others, deal with the public and media, make phone calls, maintain records, run errands, and provide for the comfort of beleaguered colleagues too preoccupied to look after themselves. No individual can perform all these tasks. People differ in their interests, levels of skill, emotional make-up, and philosophical beliefs. **Know your team and utilize their potential.**

Experienced persons can be recruited from aquariums, research stations, veterinary clinics, academic institutions, and wildlife and conservation groups. A number of teams with similar training may be required to cover a wide geographic range. Additional volunteers with no previous experience can be recruited and trained by the core group to provide extended support.

The size of the team is determined by the species and number of animals, their distribution, and the conditions under which they strand. Situations demanding prolonged work in water or exposure to cold require additional personnel for auxiliary teams (see Chapter 12). An archive of information on the size and composition of teams required under similar conditions in the past will aid in future planning.

### **Training**

Training programs can use lectures, workshops, demonstrations and audio-visual material to develop and maintain essential skills. Topics should include:

- purpose of the Network
- marine mammal biology
- stranding theories
- expected types of events; planning for each
- work standards; importance of persisting with assigned tasks



- rationale and criteria involved in decisions (see Chapter 4)
- handling and transport procedures
- first aid
- marking and tagging
- public and media relations (see Chapter 3)
- personal needs of the field party
- dissection techniques (see Chapter 10)
- collecting specimens and data (see Chapter 10)
- disposal of carcasses (see Chapter 11)
- health and safety concerns (see Chapter 12)
- the follow-up (see Chapter 13)

Trained team members can offer basic instruction to satellite groups, communities where strandings are frequent, local authorities, and volunteers enlisted at the site. Interest can be sustained through periodic workshops, demonstrations, simulated stranding drills, and the distribution of literature and newsletters.

**All strandings require a core team with a high level of skill. Mass strandings also need auxiliary personnel, not necessarily trained, whose greatest assets are their energy and willingness to cooperate. Their tasks must be clearly defined and supervised.**

The importance of working within the person's level of skill should be stressed. An identification card given to each member, coded to indicate the dates and degree of training, will facilitate task assignments at the site. Those familiar with equipment and animal handling can be quickly assigned to teams providing basic care and support. Others may be more qualified for dissection and sampling, or for staff support, communications or administrative duties.

### **Practice Drills**

Practice drills are an exercise in getting the team to a given place on time. A poor system of notification will be apparent at this point, and members who consistently fail to appear may be generally undependable. Drills reviewing each stage of the response are an effective way to check the condition of equipment, test strategies, practice safety measures, and correct defects before problems occur. Game plans can be developed for the types of animals and strandings in the region. A beach cleanup is an example of a good organizational drill that, in addition, generates positive media and community support.

## 2.5. Logistic Support

### Equipment

The Operations Center should maintain a depot of basic equipment for restraint, transport, dissection and sampling, medical procedures and supportive care (*see also Appendix A: Suggested Field Equipment*). Cranes, front-end loaders, boats, vehicles and other large items, are usually borrowed at the site from sources identified in advance. One team member should be responsible for coordinating this effort. At the stranding site, medical, dissecting and marking equipment, and data forms are best secured in a central store supervised by a trained person responsible for their distribution to team members.

### General categories of equipment

**Heavy machinery and haulage equipment:** obtainable from state, county and municipal public works departments, and from private sources (a professional operator or contractor can help with the selection). Establish availability and financial responsibility in advance.

**Foul-weather gear:** wet suits or dry suits can be rented from dive shops; dry suits are preferred for long exposure in cold water (*see 12.2*); wind-surfing suits are also useful. Everyone should be equipped with foul-weather gear (raincoat) and at least one change of clothing.

**Rescue and first-aid equipment:** the Operations Center should maintain a store of tarpaulins, buckets, shovels, ropes, lights, poles, and sheets. Additional supplies might be available from state and local fire, police and public works departments, and military installations.

**Medical needs:** human and veterinary hospitals and animal shelters may provide medical equipment and supplies, including antibiotics, fluids, administration sets, analgesics, blood sampling supplies, and euthanasia solutions. A collective of cooperating clinics and practitioners might stockpile supplies. Prepare in advance in areas where mass strandings occur.

**Diagnostic equipment:** some diagnostic techniques for hematology and blood chemistry can be adapted for field use, using compact equipment powered by a small generator. Coolers are needed to store blood and tissue samples. Local hospitals and veterinary clinics can provide more advanced diagnostic support.

**Marine equipment:** police, Coast Guard, and commercial and private boat operators often respond to the need for small vessels, foul-weather gear and radios.

**Team identification:** issue waterproof badges or wristbands coded for level of training (highly or moderately skilled, untrained), including name and institutional affiliation. Provide each person with reflective safety tape or a battery-operated or chemical light for night work.

**Animal identification:** kits for mass strandings contain:

- marking equipment (tags, tagging gun and replacement parts)
- waterproof pencil and logbooks (available from surveying supply companies)
- different colors of vinyl ribbon to identify animals for immediate release, rehabilitation, euthanasia, dissection or disposal
- large visible tags for recording vital information
- chemical lights for marking animals at night.

**Dissection and sampling equipment, protocols, data forms, photographic gear:** pre-assembled kits for obtaining, marking, and storing samples contain knives, sample bags, waterproof tags and markers, measuring tapes, and data forms (see Appendix A). In a pinch, acquire knives from commercial fishermen and butchers; make a flensing knife by fixing a machete blade (army surplus) to a long handle. Keep photographic supplies protected from moisture.

## 2.6. A Model Response

Strandings differ, as will the responses, and **basic goals and actions must be tailored to the nature of the event**. Animals in some regions come ashore singly and with predictable regularity, drawing little media or public attention and needing only a small team. Large whales and multiple strandings always attract attention and demand skillful organization. A group of ailing sperm whales, for example, will elicit an unmanageable amount of resources and help—hence the need for a plan.

### Organization

The response must be organized and structured, stressing the importance of each task that is assigned. **A clear chain of command is vital.** Each person rightfully expects to have the resources to get the job done, but must respect other overriding needs. Everyone, from the head of the operation to the person on the beach, must keep sight of the common goal.

### Notification

After learning of the event, the Operations Center requests the network representative closest to the scene to verify the report and

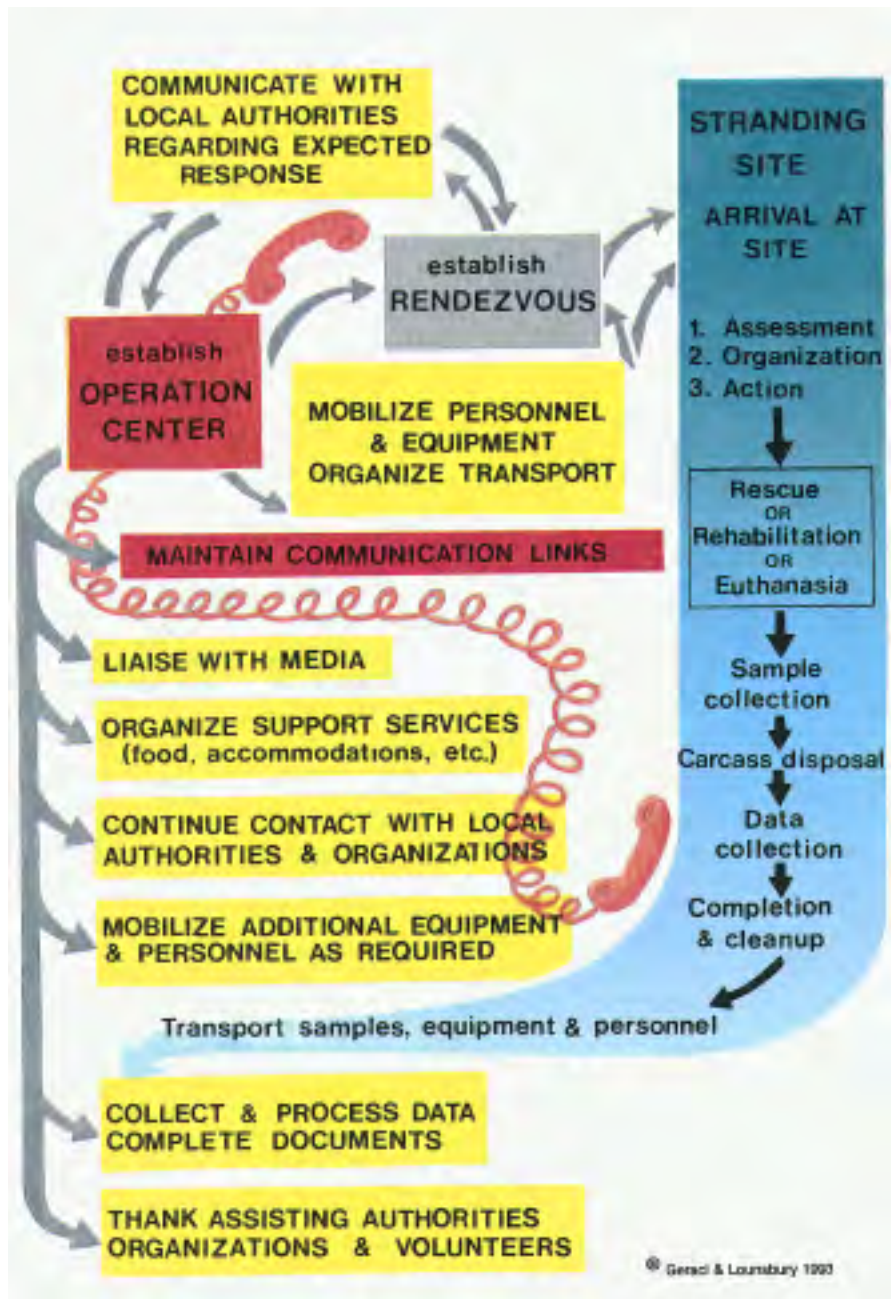
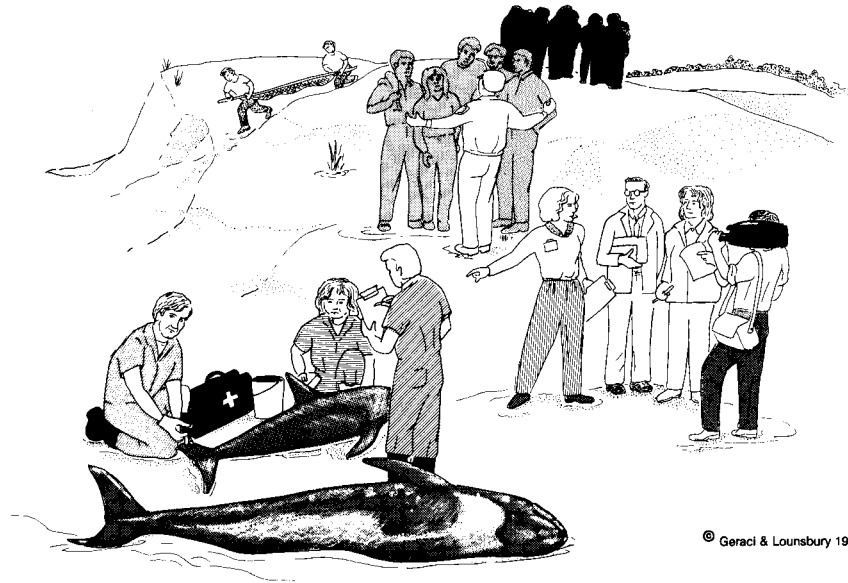


Fig. 2.2. The Stranding Response.



**Fig. 2.3.** Organization at the stranding site includes preparation for crowd control, dealing with the media, and assigning tasks to team members and on-site volunteers.

obtain basic information (precise location, tentative species identification, number of animals, whether dead or alive, weather and beach conditions, number and level of trained persons on site, level of action required, and potential complications, i.e., crowded bathing beach).

For operations involving more than one small animal, the Operations Center notifies the appropriate federal agency and confers with regional and local authorities on the intended action. An appropriate team is dispatched, drawing from the Operations Center and the region. Area representatives are often willing to take control of the stranding site and to enlist available support and services.

### **Rendezvous**

A rendezvous point is established at or near the site, with continuously monitored telephone service—perhaps a police or Coast Guard station. Badges previously issued to network members will help law enforcement officers identify the persons allowed access to controlled areas. Arriving workers can be briefed and assigned to a team before going to the stranding site. **Be sure to provide clear directions—detailed maps may be necessary.**

A designated parking area near the rendezvous point will help avoid traffic congestion and damage to the beach environment. Transporta-

tion to and from the beach can be either by scheduled shuttle, or available on demand, assuming adequate communications.

### **Coordinators**

The response team is supervised by a coordinator who directs the overall plan and communicates with the Operations Center. Large events require additional coordinators for each of the main functions (e.g., veterinary care and support, equipment access/community liaison, public information and media support, specimen and data collection, volunteer organization, and staff support and safety).

**Fatigue can alter one's perspective**, and, without a break, motivation and enthusiasm on the beach can deteriorate to the point of increasing risks to health and safety (see Chapter 12). A trained individual should be appointed to look after the comfort and safety of all personnel. In a small-scale response, the duties may simply involve locating nearby facilities (bathroom, shower, telephone) and providing food. For more complex events, the coordinator will establish a staff support center to provide first aid, shelter, food and beverages, a portable lavatory, and hot water for washing. A main center might be located at (or near) the rendezvous point, with a smaller one at the stranding site.

The staff support coordinator should also **arrange off-site accommodations for the team**, being sure to familiarize the innkeeper with the nature of the event, the inevitable round-the-clock traffic, cumbersome equipment, and untidy appearance of the guests.

The media and public relations coordinator may designate areas for media representatives and the public to gather for periodic progress reports (see Chapter 3). Other team members must refer requests for information to this coordinator.

A large response requires considerable on-site administrative work. A coordinator of volunteers will organize support staff, keep records of participants and their affiliations, maintain a check-in/check-out system, and (with the safety coordinator) schedule and supervise revolving shifts. The safety coordinator will also keep a record of reported injuries, ensure their treatment, and follow up any complications.

Specimen and data coordinators maintain the supply of dissecting and sampling equipment and data forms, monitor procedures to ensure adherence to protocols, keep track of samples processed in field laboratories or off-site facilities, and collect and organize completed forms and material (see Chapter 10).

**Communications**

The stranding site, rendezvous point and Operations Center function as a unit, through a solid line of communication that requires continuous monitoring by radio, mobile telephones, or a planned courier system. Scheduled periodic meetings with the team leader help to determine needs, report progress, and boost energy and morale. Meetings of the group coordinators maintain overall organization and set the course for the following day's activities. The team leader issues progress reports to the Operations Center, informing the staff of any needs. The Operations Center responds to requests for support and relays information to the responsible regulatory agency.

**Know your capability, operate within those limits, and do not expect more than your resources allow.**

*Chapter 3*

**Public Support and Media Relations**

**3.1.** Public Attitudes .....19  
**3.2.** Enlisting Public Support .....19  
**3.3.** Crowd Management.....22  
**3.4.** Media Relations .....23  
**3.5.** Maintaining Public and Media Support.....25  
References .....250

**3.1. Public Attitudes**

Only a few decades ago, a dead whale on the beach, or even a live one, might have been viewed as a source of food and oil, a curiosity, or merely a nuisance. Today, any live whale or dolphin, or an orphaned seal howling for its mother, is certain to evoke a different response—one that may quickly reach and influence a nationwide audience. While some would leave the animal to a natural death, or kill it as they would a stray dog, most people today expect the animals will be rescued, rehabilitated and returned to sea.

The range of personal reactions reflects the influences of education and other first-hand experiences, the media, and regional values<sup>1</sup>. The urban dweller may view a seal pup more as a pet, and the hunter or stockman may regard it with indifference. A maritime community may see it as a future threat to its fishing economy, and to the scientist, the seal pup is a source of information. These perspectives all converge at the site of a stranding. Here, attitudes can change, and unlikely alliances are forged in the common desire for action.

**3.2. Enlisting Public Support**

**Recruiting On-Site Volunteers**

Whatever their viewpoint, most individuals at a stranding are prepared to help and will respect a convincing plan and authoritative leadership. Others may be reluctant to volunteer without considerable encouragement. With proper instruction, most volunteers can be assigned to teams or supervised tasks. Individuals at the site who may have their own objectives or simply resist authority should be asked to leave. Respect the attitudes of those in the crowd who are sympathetic and supportive but wish no direct involvement. The impression gained from this experience will shape their attitude toward future events.



When more people volunteer than are needed, some criteria for selection are required. Questionnaires concerning experience, abilities and health limitations will simplify this process. Those with special skills who are determined to help, quick to recognize mistakes in the response effort, and show burning enthusiasm are best engaged as allies. When a lengthy operation is expected, ask willing individuals to return for a later shift, and find out where they might be reached in case there is a change in plans.

Do not expect volunteers recruited on-site to have the same dedication that you demand from the trained team, though you may get as much and more. Volunteers may arrive unprepared for field conditions or foul weather, or may have other obligations that require them to leave before their tasks are complete. For some, the commitment is fragile and weakens even more when their expectations about their role or contribution are not met.

### **Education**

The Operations Center conducts educational programs to increase public awareness and appreciation of marine mammals, encourage the reporting of stranding events, and promote involvement in an organized response. Augment the program with lectures, posters, distributed literature, and practice drills, and emphasize regional trends and patterns, such as mass strandings in the Northeastern and Southeastern regions, or the arrival of pinniped pups ashore in the spring.


Most individuals at a stranding will not have been exposed to the Operation Center's educational programs. Distributing information pamphlets to persons on the scene will help them determine the role they wish to play. This literature should contain basic information on the regional stranding network, a fact sheet (Fig. 3.1) on the species that has stranded, a recruitment questionnaire (see above), and guidelines on appropriate conduct, health and safety measures. It should also outline the range of actions possible, from immediate release to euthanasia.

**Rely on a designated spokesperson to establish rapport with the public** and report on progress and developments. Trained educators from schools, museums, zoos and aquariums are ideal in this role, and can also provide additional information on natural history, biology, conservation, and environmental concerns. A video display or a carcass moved within viewing distance of where public announcements are made can serve as an educational aid.

**MARINE MAMMAL STRANDING NETWORK FACT SHEET**

**Long-finned Pilot Whale**  
(*Globicephala melas*)

SAMPLE




**Range in North American Waters:** Canadian Maritime Provinces to Cape Hatteras.

**Size:** Adult males - max. 5.5-6m; adult females - max. 4.6-5m; neonates - 1.6-2m.

**Distinguishing features:** Body black with lighter anchor-shaped patch on throat; long (> 1/5 body length) sickle-shaped flippers; bulbous melon and indistinct beak; low, strongly curved dorsal fin placed well forward on the body.

**Habitat:** Highly social, occurring in small to very large groups; generally pelagic, but moving inshore in late summer to late fall.

**Stranding history:** Occasionally mass strands throughout range.



**REMINDERS!**

The **Marine Mammal Protection Act** prohibits the handling of any marine mammal, dead or alive, and the taking of any parts (i.e., teeth, skulls) by unauthorized persons.

**Stranding Network personnel** are authorized to collect important biological data during marine mammal rescue and/or carcass salvage procedures and depend greatly upon the cooperation of the public.

Marine mammals may have **infectious diseases** potentially transmissible to humans and must, at all times, be treated with caution. Whales may thrash without warning, inflicting serious **injuries** to bystanders. Remain at a safe distance from any beached live animal, unless rendering assistance.

If you have any information about this stranding or wish to volunteer assistance, please report to a Stranding Network spokesperson. For further information on marine mammal strandings or on the work of the Marine Mammal Stranding Network in your area, contact:

© Geraci & Lounsbury 1993

**Fig. 3.1.** A sample fact sheet for distribution to team members, volunteers and observers.

### 3.3. Crowd Management

#### Establishing boundaries

Large animals, mass strandings, or events on densely populated beaches often attract crowds that will require some attention to satisfy their curiosity. Observers may move in for a closer look if they are not kept informed and their questions go unanswered. The main objectives are to **reduce disruptive noise and chaos, prevent accidents, avoid further stress and injury to the animals, and allow the team to proceed with its work.**

Law enforcement officers are experienced in managing crowds; other officials, such as game wardens, marine patrol officers and park rangers, also have the legal authority to do so. The person designated for crowd management and the stranding coordinator can determine what measures need to be taken. Cordoning an area (with stakes, rope, fencing) may deter entry, but such symbolic barriers cannot be enforced without legal authority. **The public has the right to be there**, unless it is a private beach. In general, people will respect imposed limits if the reasons are clear. Establish ample boundaries for the team to work safely and effectively, with access to the ocean, and allow the public to move freely outside of that area.

Warn the public of the risks of approaching or handling a stranded animal, including physical injury (strain, bites, hypothermia) and possible disease transmission (*see* Chapter 12). A balanced view will reassure bystanders that the chance of contracting an illness from a stranded animal is slight, but remind them that a carcass is no place for a picnic.

#### Explaining Your Actions

Clearly explain the intended procedures so that actions are properly interpreted. The approach to blood sampling, intravenous medications, and euthanasia all appear the same to anyone unaware of what is in the syringe. The use of a conspicuous tag to identify all carcasses will show bystanders that the response team has not left a live animal unattended or handled it roughly.

**Do not risk an animal's welfare for the benefit of science** Weigh the values when considering collecting biopsy specimens or teeth from live animals. Opening a beached carcass for samples while other animals await attention will evoke a justifiably irate response from observers.

Circumstances on the beach can change with a rising tide, advancing weather front, nightfall, or a team's dwindling enthusiasm and resources. Keep the public informed of any variation from the expected plan to avoid confusion.

The public and many team members may be unaccustomed to euthanasia procedures and respond with questions and alarm if they are unprepared. While some are entirely opposed to the practice, **most people accept the need to end pain and suffering humanely when no other options exist**. Still, advocates may find the practice emotionally and visually upsetting. The investigators' responsibility is to explain in clear detail the need for this action (see 4.6, 4.7), how it will be performed, and possible complications. Be sympathetic to people's concerns and emotions.

The visual and emotional impact of an act of euthanasia will vary, depending on the animal. When properly done, a lethal injection administered to pinnipeds and dolphins has a quiet and rapid outcome. The same procedure in a small whale may result in a brief period of unconsciousness (anesthesia), accompanied by tail-lobbing or thrashing. There is no preferred method for euthanizing large whales. Lancing and shooting require equipment that the public may find upsetting, and their use even more so (see 6.12). Weigh the visual impact of the intended action and its effectiveness with the alternative of making the animal as comfortable as possible and allowing it to die unassisted.

**Careless remarks and inappropriate jokes reflect a callous attitude** toward both the animals' distress and the team's effort. Squabbling over procedures and samples trivializes the importance of the operation and creates a poor impression. Remember also that the media may be recording your every move.

### 3.4. Media Relations

Strandings make excellent news items—the story of nearly mystical creatures trapped in a perilous setting. The event can grow from a local report to one of incredible proportions, as did the rescue of three gray whales in Alaska<sup>2</sup>. What began as a routine ice entrapment became an international mission to free the whales, driven largely by media reports.

Nearly everyone is influenced by the media. For some, it may be the sole source of information on marine mammals and stranding events. The more information we can provide, the more accurate the coverage will be, and, in turn, the greater the educational value and benefit to the

stranding network. A timely newspaper article can prevent the “rescue” of a healthy seal pup awaiting the imminent return of its mother.

### **Organization**

The stranding network’s **media coordinator is at the heart of the operation**. Suitable candidates can be recruited from the media relations department of a marine mammal display facility. The general responsibilities of the position include:

- developing strategies for providing information to the public
- educating staff and volunteers on how to interact with the media
- providing the media with up-to-date material, including press kits
- maintaining a phone list of key staff and press contacts
- planning consistent coverage of stranding events

A press kit might include a regional map, stranding patterns and brief sketches of the animals typically involved (Fig. 3.1), as well as a description of the network (from federal to local level), and a list acknowledging donors, contributors and associated scientists.

Take the initiative to contact the press and keep them informed with information that is consistent and supportable. Maintain a good working relationship by avoiding unreasonable demands and being cooperative. Do not expect the press to appeal for volunteers and equipment during an event (the response is unmanageable in any case). Make them aware that you expect reporters to identify themselves and to minimize disturbance and interference on the site (e.g., low-flying aircraft).

### **At the Scene**

The media coordinator is responsible for providing substantial, accurate information, thus avoiding a distorted story based on speculation and opinion. Neither the team leader nor other members will have the time or information to assume this role, and must defer questions when approached. At the stranding scene, press kits can be distributed from established communications stations to media representatives. Directions to the nearest public telephones will be greatly appreciated.

Specify the times and locations of regular press briefings to be given by the designated media spokesperson, and include at least one of the investigating scientists on a predetermined schedule to satisfy the inevitable search for “better answers.” **Conflicting views are unavoidable and can be presented to the media as a normal part of scientific inquiry. Avoid public arguments;** the stranding site is not the place to try to resolve such differences in any event. Media represen-



tatives will appreciate the names and phone numbers of other experts in the field if they choose to pursue the story in more depth.

### 3.5. Maintaining Public and Media Support

#### Beach Etiquette

Team members consumed by enthusiasm and fatigue easily forget that motel staff are not accustomed to dealing with cluttered rooms and messy guests, and that no one appreciates the sight of bloody bootprints while dining in their favorite family restaurant. Caution all personnel to **respect the sensitivity of local residents and businesses**. Unless you have had time to change out of your field attire or clean up, consider take-out food. Such courtesies will go a long way toward securing a base of support for future operations.

#### A Word of Thanks

A firm note of thanks will help keep the public and media trust and support, hard-earned throughout the event. Let them know the value of their participation and the outcome of the effort (see Chapter 13). **Make a point of personally thanking the local community.**



*Chapter 4*  
**Decisions on the Beach**

4.1. When to Intervene.....	27
4.2. What are the Options?.....	28
4.3. Criteria for Making Decisions.....	28
4.4. Immediate Release as an Option.....	32
4.5. Rehabilitation as an Option.....	33
4.6. Euthanasia as an Option.....	33
References.....	251

**4.1. When to Intervene**

**Not every animal on the beach needs help.** Pinnipeds and sea otters normally require periods of time out of water, and even some cetaceans, which are virtually helpless on land, may occasionally cross the boundary between sea and land without undue risk. A beluga whale may come ashore to rub free a winter’s accumulation of sloughing skin, a killer whale to snatch an unsuspecting seal, and a bottlenose dolphin after playfully riding a wave into the surf. Recognizing normal behaviors will avert any unnecessary action.

**Certain conditions demand attention.** A sea otter that is coated with oil, a fur seal too feeble to move or a manatee with crippling propeller wounds is by any measure disabled and cannot recover without help. The same may be true for an animal in impending danger, for example: a subarctic hooded seal on a Florida beach or headed inland across a highway, or perhaps a harbor porpoise trapped in a fishing weir. Their peril is not as immediate as that of a dolphin on a hot beach, but they are nonetheless in difficulty and have a better chance of surviving if given some attention. “Nuisance animals” are a concern primarily in areas of dense human population<sup>1</sup>. A California sea lion intent on following humans off the beach or determined to sleep on someone’s front porch calls for action.

In time, every would-be rescuer faces an animal in circumstances that are ambiguous, in which the risk to health is debatable, and any action taken is certain to be questioned. What should be done for a lone young bottlenose dolphin marooned in a northern bay at the onset of winter, or a humpback whale that may (or may not) be too far upriver to find its way back, or the howling seal pup awaiting its mother’s return from a foraging trip? Deciding what action to take in these situations requires an understanding of the animal’s natural history, what typically happens





when such animals are left alone, and intuition that comes only with experience (and mistakes).

In making any decision, we should keep in mind that a rescue effort is notice to the public and authorities that the animal needs help, whether it really does or not. And aborting the plan because the seal pup suddenly woke up and dashed back to sea may be viewed by the public as a failed attempt, even if it is not. These uncertain situations, beyond all others, require firm planning with the help of experienced colleagues.

## 4.2. What Are the Options?

Once the decision is made to intervene, three options for immediate action are to return the animal to sea, transport it to a care facility, or euthanize it. The decision is simple when dealing with a healthy stray that needs only to be returned to a suitable habitat, or, at the other extreme, an animal that is clearly beyond help.

Most situations are more complex, and managing them must take into account, among other things, the likelihood of success and the safety of the operation. The “Decision Guide” (Fig 4.1) begins with the broadest question common to all situations—is there enough help available? From there, a series of criteria will guide the approach one might use in most circumstances. As the options are weighed, the most important maxim is to **take no action that will only prolong suffering**

## 4.3. Criteria for Making Decisions

### Logistic Support

**Almost anything is possible with adequate resources; little or nothing can be done without them.** An experienced, organized, and well-equipped response team is of paramount importance. Involvement of volunteers with little or no training must necessarily be limited to non-hazardous activities. Good planning will ensure that the required level of support and expertise is available, and help to guarantee the success of the operation. Attempting too much with too little causes needless risk to both the workers and animals. Dragging a pilot whale across a rocky beach for lack of a decent carrier, or holding a seal in an unventilated box are harmful actions, and unnecessary if help is only an hour away.

### How Many Animals?

A small animal on an accessible beach usually requires simple straightforward action—few persons and little equipment—whereas a sperm whale or mass stranding is certain to stretch resources and

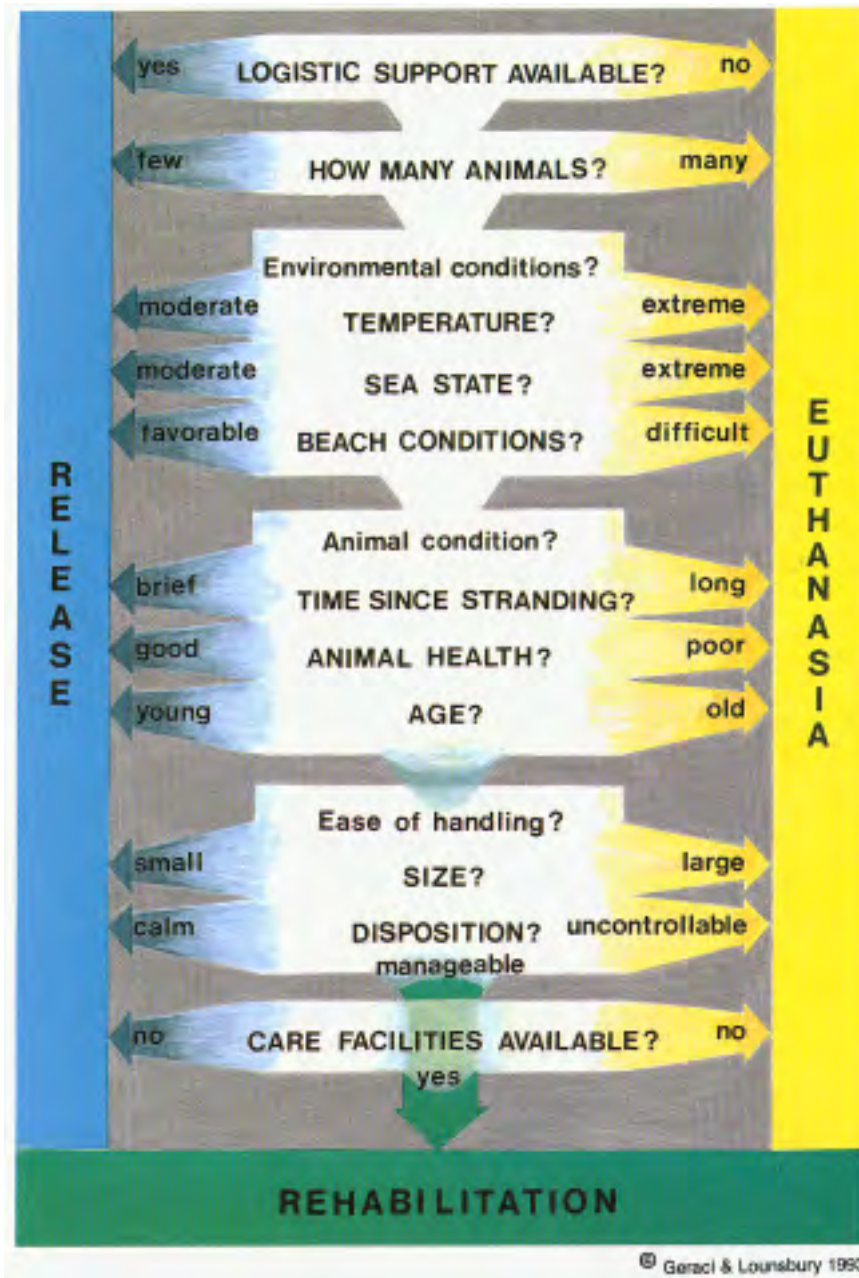


Fig. 4.1. "Decision Guide" for live animals.

demand an organized response. Most exacting are the large events of long duration, such as an extended die-off along a vast shoreline. In such circumstances, it will usually be necessary to husband resources by being selective and to refrain from planning the type of exhaustive, uniform approach required (at a cost of nearly \$20 million) to rescue and rehabilitate sea otters after the 1989 *Exxon Valdez* oil spill<sup>2</sup>.

**Attempting to give equal attention to more animals than resources permit assures inadequate care for anyone.** The action plan for a cohesive group of stranded pilot whales must take into account their social needs as well as physical health (see Chapter 7). A lone young survivor is not likely to prosper if it is released in an area devoid of other pilot whales, and may be better placed in a permanent care facility.

### **Environmental Conditions**

The action plan must take into account the time of day, beach topography, sea state and weather conditions. The terrain may be too rocky, muddy, or littered with sharp debris to drag animals safely or use vehicles. Remote locations are naturally more difficult to manage. The configuration of some beaches changes seasonally (a harmless surf zone in the summer may become a dangerous undertow in winter) and regionally (a riptide caused by a nearby jetty). Harsh terrain, rough seas, darkness, or simply a rising tide can increase the risk to animals and the team, and impede the rescue effort.

Severe weather may force a change in plans, limiting one's options to observing the animal, offering minimum protection, and euthanizing it when conditions are appropriate. Consider moving the stranding to a safer site for first aid, rather than releasing it into the danger of a heavy surf.

Cetaceans and pinnipeds are prone to **hyperthermia**. Their dark colors absorb heat, and blubber contains it. Circulatory adaptations for cooling are not efficient on land and break down completely with the onset of shock. For many reasons, the larger the animal, the greater the problem. Adding to hyperthermia are dehydration from hot winds and the destructive effects of sunburn (see 6.6). Pinnipeds may haul out on a hot beach for brief periods and are not necessarily in need of rescue. A cetacean on a hot beach requires immediate attention.

A manatee in cold water and a sea otter whose coat has lost its insulating properties are subject to **hypothermia**. This is less a problem with healthy pinnipeds and cetaceans. However, cold temperatures can affect those with insufficient blubber—a characteristic of many of the

seals and dolphins that come ashore. Small animals are more vulnerable to cold stress because their surface area is large compared to their mass. Extreme cold can cause frostbite and necrosis of the trailing edges of the flukes and fins of even robust whales, and may be hazardous to the response team, especially those working in the water (see 12.2).

Wind exaggerates the effects of low temperature and hastens the onset of frostbite. Sand is irritating to the eyes and mouth, and can be blown with enough force to etch glass, scour paint, and injure tissues of the animals and their attendants.

### **Animal Condition**

A healthy animal is resilient, whereas one that is ailing may not survive the ordeal associated with the rescue. However, it is not always possible to distinguish between the two from their outward appearance. In fact **it may be difficult to determine at a distance whether a whale is living, much less in good health.** Marine mammals seldom display expressions or postures suggestive of pain or discomfort, or abnormal behavior unless seriously ill. The body contour of cetaceans and pinnipeds is formed largely by blubber, which retains its basic shape even when the animal has lost weight. A decrease in blubber eventually leads to hypothermia, sooner in cold waters than in warm. Thus, a dolphin in northern latitudes dies before becoming emaciated, but in the tropics may linger to become a very lean specimen. For the most part, **the health of an animal can be determined only after rigorous clinical examination.**

For some species, the options are predetermined. Sea otters and adult pinnipeds are generally too debilitated by injury or disease to be immediately returned to sea. Singly stranded odontocetes are usually ill as well, or may be separated from a vital social group. The fate of these animals after release is uncertain; consider a care facility as an option.

Larger, older animals generally decline in health more rapidly than smaller ones. In pinnipeds, this is because most adults are disabled by injury and disease, whereas pups and juveniles come ashore often needing only food. Large size is detrimental to beached cetaceans because of the proportionally damaging effects of mass and gravity.

Prompt action can slow but not entirely arrest the deterioration of an animal's health on the beach. Pilot whales released within 24 hours of coming ashore have re-stranded days later, still showing morphologic and biochemical evidence of **stress and shock** caused by the first event<sup>3</sup> (see 6.6). Little of this could have been gleaned from the physical

appearance of the whales when they were pushed out. Blood chemistry might have been more revealing, but the analyses take time. Before returning any animal to sea, consider that the process of recovery may take longer than environmental conditions will allow.

### **Ease of Handling**

The ability to approach, handle and move an animal depends on its size and demeanor. Some are small enough to be picked up by hand, have the disposition of the family dog, and might even tolerate a car ride to the nearest facility, assuming a suitable cage is available. At the other extreme are animals that are too cumbersome to move without unacceptable risk. Little can be done for a large whale cast high and half buried on a silted beach during a spring tide, or for a vicious, old and injured walrus bull. Most circumstances lie somewhere in between.

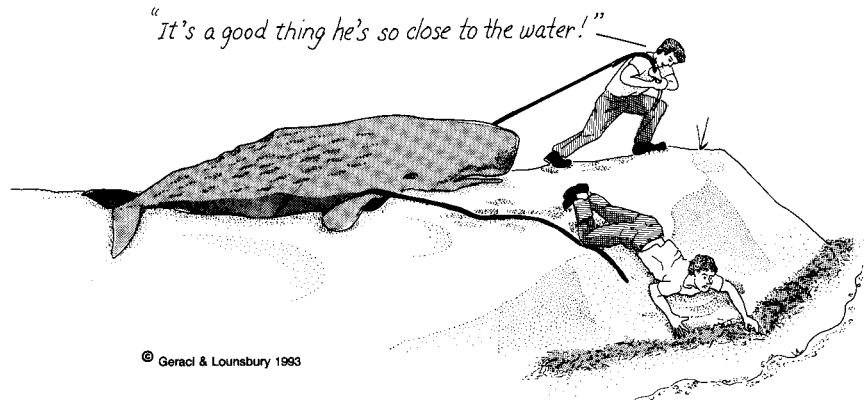
**When in doubt, consider first the interest of the animal and the safety of the attendants.**

## **4.4. Immediate Release as an Option**

Return to sea is an option when:

- the animal is manageable and logistic support adequate
- beach and environmental conditions are favorable
- the animal is healthy and able to function normally
- social requirements can be met (e.g., maternal care for young)
- the area of release is within the natural range, suitable (out of harm's way) and navigable

**Singly stranded odontocetes, and sea otters or pinnipeds unable to leave the shore, are usually poor candidates for immediate**



**release.** Whether or not to release a large whale or smaller mass-stranded cetaceans will be determined almost entirely by the available logistic support. When dealing with the latter, attention should be given first to younger animals, those in good health, and those on the beach for the shortest time (*see* 7.6). **Before returning animals to sea, a plan should be in place for visual or electronic monitoring.**

#### 4.5. Rehabilitation as an Option

Rehabilitation is an option when:

- there is a good chance the animal can be restored to health
- facilities are available and equipped for the species and number of animals involved
- arrangements can be made for safe and expeditious transport
- the animal is manageable and poses no major risk to others or to facility staff
- there are sufficient funds and staff to provide care for a reasonable period

Care facilities are increasing in number, capacity, and expertise for dealing with manatees, sea otters, and most pinnipeds and small cetaceans. There are only a few commercial institutions large enough to accommodate a young gray whale or killer whale; most can only handle those up to the size of a pilot whale. Still, **the numbers of marine mammals coming ashore annually exceeds the capacity of existing institutions.** This pressure will increase as stranding programs continue to develop, thereby limiting rehabilitation as an option.

#### 4.6. Euthanasia as an Option

Euthanasia is an option when:

- it is necessary to end suffering of an animal in irreversibly poor condition
- the decision can be made and the action directed by an experienced, qualified person
- essential materials and equipment are available
- the procedure can be carried out humanely
- no rehabilitation facility is available for orphaned dependent young
- rescue is impossible and no care facility is available
- animals persistently restrand

- a distressed cetacean ashore is likely to attract others milling nearby to mass strand

**Euthanasia for marine mammals is a contentious issue**, much more so than the accepted practice of terminating the life of a pet or other domestic animal. Anyone facing this option should be prepared for opposition from both the public and other team members.

The Animal Welfare Act defines euthanasia as the humane destruction of an animal, using a method that produces near instantaneous unconsciousness and rapid death without evident pain or distress, or using anesthesia to produce painless loss of consciousness.

Intravenously administered anesthetic agents and euthanasia preparations that have been used successfully in pinnipeds and small cetaceans satisfy this definition; other approaches (e.g. firearms, suffocation) may not, particularly on large whales (*see 6.12*). **A clumsy attempt to euthanize an animal without adequate equipment or expertise can cause more suffering than a natural death**, and promotes greater reluctance to accept euthanasia as a humane alternative.

In practice, public response influences the method of euthanasia, not necessarily because of humane considerations, but for aesthetic reasons. Consider the reaction to shooting a seal or draining a whale of its blood on a public beach. These considerations aside, there is often philosophical opposition to euthanasia. Some find the practice unacceptable under any circumstance. Others, including team members, may be unwilling or unprepared to accept this action after having struggled earlier to save the animal's life.

At the stranding site, the topic of euthanasia must be broached with tact and consideration. Members of the response team, the general public and the media should be informed of the procedure in all its dimensions: the reasons, the approach, and possible complications (*see Chapter 3*).

*Chapter 5*  
**Pinnipeds**

5.1. Biology .....	35
5.2. Mortality .....	40
5.3. Stranding Patterns .....	43
5.4. Stranding Response .....	44
5.5. Approach and Handling .....	47
5.6. First Aid.....	50
5.7. Immediate Release .....	51
5.8. Transport to Care Facility .....	51
5.9. Rehabilitation .....	52
5.10. Release Following Recovery.....	54
5.11. Euthanasia.....	56
5.12. Pinnipeds in U.S. and Adjacent Waters .....	57
References .....	251

**5.1. Biology**

**Anatomy**

The Suborder **Pinnipedia** includes the sea lions and fur seals (family **Otariidae**), the walrus (**Odobenidae**), and the “true” or “hair” seals (**Phocidae**). Whether this diverse group arose from a single terrestrial ancestor or two separate lines is still a subject of debate<sup>14</sup>. The latter view holds that otariids and the walrus descended from dog-bear stock, and phocids from otter-like carnivores<sup>80,90</sup>. Convergent evolution to meet environmental constraints would then account for shared characteristics such as streamlined body shape, limbs modified as flippers, simple grasping teeth suitable for catching fish, and diving and thermoregulatory mechanisms<sup>54,90</sup>. (See **5.12** for distinguishing features of each family.)

Certain obvious features distinguish phocids from otariids (Fig 5.1). Most notable are their contrasting methods of **locomotion**<sup>54,63</sup>. Phocids move awkwardly on land. Unable to turn the hind flippers forward to support themselves, they must hump along on their bellies, using their short foreflippers for an occasional boost ahead. They are more graceful in the water, propelling themselves by sculling with their hind flippers and using the foreflippers for steering. Otariids depend on paddle-like movements of the forelimbs for swimming, and on the hind flippers and a long neck for steering. Using both the fore- and hind flippers, they move on land with a speed and agility that allow them to utilize high rocky



habitats inaccessible to phocids. The walrus, somewhere in the middle, uses the hind flippers for swimming, foreflippers for steering, and both sets of limbs for moving on land.

In fetal life, phocids develop a coat of woolly lanugo hair. Hooded seals, most harbor seals and some bearded seals shed the lanugo *in utero*, while other species shed theirs a few days to several weeks after birth. Hair has little insulating value for adult phocids, and they depend on a thick layer of blubber to retain body heat. **Otariids are less tolerant of cold** and rely more on their dense pelage. Fur seals, at least, must remain active to prevent hypothermia when in cold water<sup>39</sup>.

The **dentition** of most pinnipeds is rather simple<sup>43,63</sup>. Deciduous or milk teeth in phocids are resorbed before birth or shed shortly after, and those of otariids, within 3 to 4 months. All teeth behind the incisors and canines have a nearly uniform shape characteristic for each species, and are referred to simply as “post-canines.” The canines have annular rings in cross section that can be used for determining the animal’s age.

Pinniped **internal anatomy** is similar to that of most carnivores<sup>43,63</sup>, with a simple stomach, small intestine, caecum, large intestine, and a multi-lobed liver. The elongated thorax stretches the diaphragm in a decidedly oblique orientation. The lungs of some species (e.g., ribbon seal) are made firm by microscopic cartilaginous coils that surround the airways, resulting in a lumpy texture. The cardiovascular system is specialized for diving<sup>23</sup>; one obvious adaptation is the immense hepatic sinus, an enlargement of the vena cava that, when constricted by a sphincter at the diaphragm, acts as a reservoir of oxygenated blood during a dive. Like those of cetaceans, pinniped kidneys are lobulated. The female genital system is similar to that of terrestrial carnivores. The testes in the Phocidae and the walrus are in the inguinal region, concealed between the blubber and the abdominal muscles. Otariids, in contrast, have a scrotum into which the adult testes descend during the mating season.

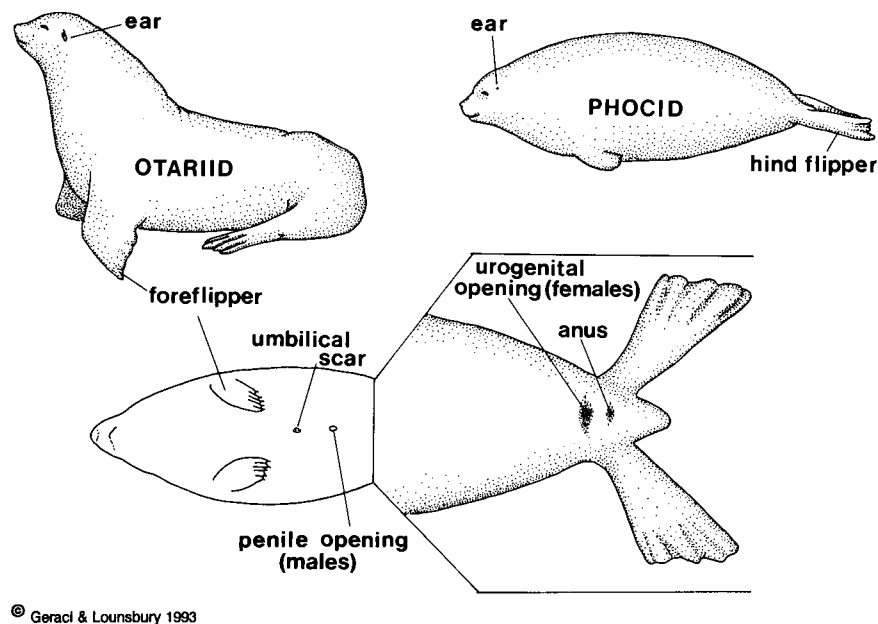
### **Natural History**

Females of most pinniped species become sexually mature by about 4 to 6 years of age, with some as early as 3 years (northern elephant seal) and the walrus as late as 6 to 9 years<sup>31,63</sup>. Males reach **sexual maturity** at about the same age or slightly older, but may not breed successfully until several years later. This is particularly true of highly gregarious species.

The 11- to 12-month **pregnancy period** includes a 2- to 4-month phase during which the newly fertilized egg develops into a blastula,

then remains dormant until the mother's hormonal levels allow development to proceed. By delaying implantation, the female can give birth during the same brief time each year when conditions are ideal for both mating and rearing pups. This synchrony is particularly important in polar environments. The walrus, which breeds every 2 or 3 years, has a pregnancy period of around 15 to 16 months, including 3 to 4 months of delayed implantation<sup>31</sup>.

The **nursing period** of phocids is typically 3 to 6 weeks<sup>43,63</sup> but has been compressed to an impressive 4 days in the hooded seal<sup>11</sup>. Females of most species remain with their pups continuously until weaning; harbor and ringed seal mothers may leave to feed for brief intervals. Otariids provide maternal care for a few months to a year or more<sup>42,63</sup>.



**Fig. 5.1.** External morphology of seals (*Phocidae*) and sea lions (*Otariidae*). The gender of a pinniped is easily determined. In the female, the anus and vagina lead into a common opening ventral to the base of the tail. The male has two widely separated openings, with that for the penis a few cm behind the umbilical scar. There is a well-developed baculum (penis bone). The distinction between young males and females usually requires close examination and manipulation. As the animals mature, there are often prominent secondary sexual characteristics that can be discerned at a distance. For example, the males are usually larger and more robust and, in otariids, may develop sagittal crests and manes. (After Geraci 1981.)

During this time the female periodically makes lengthy foraging trips. Walrus calves may begin to feed upon bottom-dwelling invertebrates as early as 5 to 6 months of age, but usually continue to suckle, at least as a dietary supplement, until about 2 years old<sup>61</sup>. **Knowing the maternal care patterns of pinnipeds in the region will help reduce the common mistake of picking up a healthy pup that is merely awaiting its mother's return.**

While generally favoring fish and squid, pinnipeds have a varied diet that may also include invertebrates, mammals, and birds<sup>62</sup>. Most species, and certainly individuals, show distinct preferences in their choice of prey, often determined by seasonal or regional abundance. Some species, such as the harbor seal and California sea lion, feed in coastal waters and often enter rivers. Others, such as the northern fur seal, northern elephant seal and gray seal, forage in deep water, well offshore. Walruses and Steller sea lions occasionally prey upon other species of pinnipeds<sup>41,71</sup>.

### **Distribution**

Pinniped **demography** is tied to a crucial need for land or ice on which to give birth and rear the young, social organization (solitary or gregarious), and methods of exploiting food resources<sup>4</sup>. Regional stranding patterns clearly reflect these elements of life history. Orphaned pups of coastal harbor and elephant seals as well as California sea lions come ashore near rookeries with seasonal predictability, while adults strand in a scattered procession along their migration routes. Harp, hooded and ribbon seals undoubtedly become orphaned and sick as well, but since they live far out at sea, hauling out on ice rather than land, few casualties ever reach shore. **Knowledge of the normal patterns of animal distribution, habitat use and stranding is vital to recognizing unusual events.**

Pinnipeds normally **range** throughout coastal areas of the United States and Canada, except in the southeastern U.S. and the Gulf of Mexico (see 5.12). The East Coast features only phocid seals and the walrus; the latter was once common as far south as Sable Island, Nova Scotia, but is now restricted to waters from Labrador northward<sup>2</sup>. Bearded and ringed seals occur year-round in the Arctic<sup>5,78</sup>. Hooded and harp seals breed on springtime ice floes in the Gulf of St. Lawrence and east of Newfoundland<sup>88,91</sup>. Gray and harbor seals range from Labrador to Cape Cod<sup>10,73</sup> and even farther south. Harbor seals are the most common type to strand along the East Coast; gray seals, which are more pelagic, trail by a wide margin. Less frequent but increasing

incidents involve harp, hooded and ringed seals that stray from northern populations<sup>30</sup>.

The California sea lion ranges from the Gulf of California, where it is the only resident pinniped<sup>81</sup>, northward to Vancouver Island. This species accounts for the majority of strandings in California<sup>98</sup>. The Steller sea lion occurs along more northern parts of the West Coast, with primary haul-out and rookery sites in British Columbia, the Gulf of Alaska, and the Aleutian Islands<sup>7,52,96</sup>. Steller sea lion numbers in the western Gulf of Alaska and eastern Aleutians have declined alarmingly since the late 1950s and continue to do so, although the causes of this loss remain uncertain<sup>69,75,79</sup>. The northern fur seal has a similar range. Principal fur seal rookeries in North American waters are in the Bering Sea (St. Paul and St. George islands). There is one additional rookery off southern California (San Miguel Island)<sup>38</sup>. Outside of the breeding season, this species is largely pelagic and rarely found ashore.

The ubiquitous harbor seal ranges in the eastern Pacific from Baja California to the Aleutians and the southern Bering Sea. They can be found along the open coast as well as in protected areas such as estuaries and rivers<sup>5,6,53</sup>. The northern elephant seal, the largest of the North American phocids, resides primarily on islands off California and Mexico's Baja Peninsula but also migrates northward to British Columbia and the Gulf of Alaska during the warmer months<sup>77</sup>. Recent tracking studies suggest that summer migrations to the eastern Aleutian Islands may not be unusual<sup>22</sup>, and one stray has been reported as far afield as Midway Island in the Hawaiian chain<sup>48</sup>.

Farther north, the ringed seal, one of the smallest pinnipeds, is the most abundant phocid in Alaska and the Canadian Arctic. Rarely seen on land, these seals occupy shorefast ice, where they can maintain breathing holes in surfaces more than 2 m thick<sup>56,103</sup>. Bearded seals occupy a wide range of habitats over the continental shelf, preferring depths of 25-50 m<sup>13,57</sup>. The Pacific walrus is limited to the Bering, Chukchi, and western Beaufort seas and breeds on offshore ice<sup>31,99</sup>. During summer months, adult males occupy traditional haulouts on land, mainly in Bristol Bay<sup>70</sup>. Females and young may haul out on land during fall migration and when ice is unavailable<sup>31</sup>. Spotted seals pup and mate in pack ice in the spring but haul out on shore after the ice has retreated<sup>86</sup>. The elusive and strikingly marked ribbon seal is virtually pelagic and rarely ventures near shore<sup>13,14</sup>.

The only pinniped native to the Hawaiian Island region is the Hawaiian monk seal, which is largely restricted to the westernmost islands of

the chain. This most tropical of phocids is truly in danger of extinction, facing every conceivable threat, including human encroachment, natural poisoning and predation, and, for females, mutilating sexual attacks by male monk seals<sup>60,75</sup>.

Pinniped populations in North American waters range from less than 1,500 Hawaiian monk seals<sup>75</sup> to about 2 million harp seals<sup>100</sup>.

## 5.2. Mortality

### Natural Mortality

As in other mammalian species, **mortality in pinnipeds is high in the very young, decreases rapidly with maturity, and increases again in advanced age**<sup>87</sup>. Generally between 10 to 20 percent of pups die before they are weaned, and 20 to 50 percent of all newborns may not survive the first year<sup>5,61,67,73</sup>. **The leading causes of pup mortality are accidental separation or premature abandonment due to storms, crowding, trauma, illness, insufficient food, or human disturbance, followed by starvation**<sup>2,61,66,94</sup>.

**Rookeries can be dangerous places for pups and adults when population density increases**<sup>2,17,67</sup>. Young northern elephantseals<sup>66,67</sup>, Hawaiian monk seals<sup>112</sup>, Steller sea lions<sup>94</sup> and Pacific walruses<sup>31</sup> are bitten or trampled by adults, which also are victims of aggressive encounters. Injured animals may die of their wounds, or through ensuing infection, starvation or increased predation<sup>61,92</sup>.

The security of a rookery is also undermined by **weather conditions**. Storms, unusually high tides, and persistent and extensive ice cover have resulted in the loss of nearly the entire season's pups of northern elephant seals<sup>17</sup>, northern fur seals<sup>61</sup>, and Steller sea lions<sup>94</sup>. Polar species are threatened by ice that can crush them or trap them out of water<sup>56,78,100</sup>. The only known natural mass harp seal mortality followed a severe winter storm in the Gulf of St. Lawrence in 1973, in which hundreds, perhaps thousands, of dependant pups and their mothers were crushed by broken ice.

One of the more elusive factors affecting population vitality is the gradual or sudden **decline in available food**. For example, Galapagos fur seals and sea lions faced widespread starvation when the abundance and quality of prey declined profoundly in waters warmed by the 1982-83 El Niño event<sup>110</sup>. "Pinniped hyponatremia," a fatal disease induced by stress, was diagnosed in free-ranging Arctic ringedseals<sup>46</sup> at a time when persistent ice interfered with food production<sup>103</sup>. Pacific

walruses have evidently reached or exceeded “carrying capacity”—the number of animals the environment can support. The resulting nutritional stress, together with disease, is believed to be responsible for the increased juvenile mortality observed since the mid- to late 1970s<sup>33,34</sup>.

**Predators** take their toll on certain species. Foxes in some Arctic regions consume or kill as many as 40 percent of ringed seal pups hidden in the illusionary safety of their birth lairs<sup>101,103</sup>. Polar bears and walruses prey on juveniles and adults<sup>71,102</sup>. Steller sea lions, killer whales and sharks eat northern fur seal pups<sup>41,61,115</sup>. Harbor and gray seals in the Northwest Atlantic<sup>12,106</sup>, Hawaiian monk seals<sup>112</sup> and California sea lions are also taken by sharks, while coyotes kill significant numbers of harbor seal pups in certain coastal regions of Washington<sup>105</sup>. Predator-inflicted injuries may bring pinnipeds ashore, and eventually into rehabilitation centers.

**Toxins** produced by marine algae can be carried through the food chain, poisoning a predator somewhere along the way. As captain of the schooner *Antarctic* in the early nineteenth century, Benjamin Morrel recorded a mass mortality of Cape fur seals at Possession Island in southwest Africa. A fresh appraisal of Morrel’s findings suggests the event might have been caused by toxic dinoflagellates<sup>13</sup>. Clusters of northern fur seals<sup>61</sup> and, in one instance, Hawaiian monk seals<sup>48</sup> died in circumstances also suggestive of natural poisoning.

Virtually all adults and most weaned pups serve as either intermediate or definitive hosts for **parasites** of all kinds (see 10.12). Mites occupy respiratory passages and lice dwell on skin. Cestodes and nematodes are ubiquitous, and include gastrointestinal roundworms, tapeworms, hookworms, as well as heart and lung worms<sup>44</sup>. Except for fatal episodes of infection by hookworm in northern fur seal pups<sup>61</sup> and lungworm in California sea lions, northern elephant seals and harbor seals<sup>18,36</sup>, parasites seem to have little obvious effect on the well-being of a healthy host. However, stress and pre-existing illness can upset the balance, transforming innocuous parasites into serious pathogens that induce pneumonia, gastric ulcers, intestinal inflammation and a host of other ailments<sup>44</sup> seen in stranded animals.

Ailing pinnipeds eventually die of **diseases** brought about by a variety of pathogens. Except for leptospirosis in California sea lions<sup>26,47,97</sup> and northern fur seals<sup>115</sup>, bacteria are not significant primary agents of disease. However, as secondary invaders, they can kill animals already stressed by habitat degradation, malnutrition, parasites and other pre-existing conditions<sup>2,107</sup>. Infections complicate traumatic wounds<sup>61,66</sup>,

even the mild irritations that arise when a young pup drags its exposed umbilicus along a sandy beach<sup>92</sup>. **From a practical standpoint, we recognize that bacterial infections can mask or overwhelm the clinical picture of a stranded animal and therefore demand immediate attention.**

Diseases, if severe enough, can reduce populations. Viruses, once considered insignificant in natural mortality, have suddenly emerged as serious pathogens in certain species. The 1955 die-off of crabeater seals (2,500 dead) in the Antarctic sparked an investigation that stirred the first empirical diagnosis of viral disease<sup>65</sup>. The unaccounted mass mortality of Galapagos sea lions in the 1970s<sup>42</sup> is also suggestive of a viral agent. In 1979-80, an influenza virus swept through the winter population of New England harbor seals, killing at least 450 animals<sup>45</sup>, and influenza continues to strike there in modest form. In 1987, a morbillivirus (related to human measles and canine distemper) named Phocine Distemper Virus (PDV-2) killed several thousand seals in Lake Baikal. No one was prepared for the ensuing epidemic caused by another strain of the virus (PDV-1) that eventually claimed more than 17,000 harbor seals in the North Sea<sup>50,59,83,111</sup>. In searching for the origin of the virus, investigators have noted isolated cases of disease in seals along the North American east coast<sup>19,28</sup> and have detected antibodies in harp seals sampled from Greenland prior to the epizootic<sup>76</sup>.

Why the sudden increase in virus-induced mortalities? Such large-scale events would not have gone unrecognized in recent history, suggesting that these outbreaks are indeed a new phenomenon. Circumstances are changing: **protected animal populations are expanding; human occupation and industrial activity in coastal waters are increasing; sophisticated fisheries operations are competing for dwindling food resources; increasing air and water temperatures are influencing pinniped behavior and distribution; and habitats are showing the effects of chronic contamination**

#### **Human-Related Mortality**

Our attitude toward pinnipeds, among other animals, is partly shaped by social and regional values that span both ends of the ideological pole. **A seal just released from a benevolent recovery program may find itself in the cross-hairs of a gunsight** if it chooses to invade a pen of cultured salmon. Consequently, it may reappear for a second round of rehabilitation—if lucky. Despite legal protection, some animals are shot because they are considered a nuisance or threat, among them Steller sea lions<sup>52</sup>, Pacific harbor seals<sup>105,108</sup>, and, in increasing numbers,

California sea lions<sup>20,36,49</sup>. Only 2 of the more than 2,000 harbor seals examined by the New England Aquarium since 1972 have been gunshot fatalities. A far greater number of pinnipeds is taken in native hunts—particularly phocid seals<sup>56,57,58,103</sup> and walrus<sup>31</sup> in the Bering, Beaufort, and Chukchi seas.

The number of pinnipeds killed or injured deliberately is insignificant compared to those that succumb to fishing net or **marine debris entanglements**. Fisheries-related mortality is high in Pacific harbor seals<sup>52,97,108</sup>, Steller sea lions<sup>52,69</sup>, Hawaiian monk seals<sup>75</sup>, harp seals<sup>68</sup>, and northern fur seals<sup>35</sup>. Hawaiian monk seals and northern fur seals also become entangled in plastic debris, such as packing bands and straps<sup>64</sup>.

Other forms of human disturbance may be as pernicious, but their effect is not always measurable. **Human intrusion** on beaches was blamed for an increase in pre-weaning mortality among Hawaiian monk seals on Midway and Kure atolls in the 1950s-'60s<sup>60,112</sup>. **Oil spills** have contaminated seals and fouled their coats, killing some and undoubtedly harming others<sup>93</sup>. **Pollution** has been linked to reproductive failure in certain pinniped populations<sup>21,51,89</sup>, although no firm evidence for a cause-effect relationship has been demonstrated<sup>1</sup>.

### 5.3. Stranding Patterns

With some exceptions, a stranded pinniped is likely to be a species that resides in the area permanently or seasonally, or that finds its way ashore at some point along its migratory route. In fact, stranding data are useful for mapping resident locations and movements of some species. Northern elephant seals and harbor seals in California faithfully reoccupy rookeries in the winter and spring months; some of their pups are certain to strand nearby. In winter, the animals may go elsewhere, as do harbor seals from maritime Canada that retreat southward to join dense colonies on Cape Cod. Armed with facts on the life history of a specific region's pinnipeds, **one can reasonably predict the time and place that a given segment of the population is likely to strand.**

Yet, there will always be unexpected appearances. With increasing frequency, young hooded seals wander from their subarctic ice sanctuaries in northern Canada to Massachusetts, and rarely as far south as Florida<sup>82</sup>. One bizarre journey, probably across the Canadian Arctic<sup>6</sup>, brought a healthy young female hooded seal ashore in southern California<sup>27</sup>. Harp and ringed seals are also appearing well south of their historical ranges<sup>30</sup>.



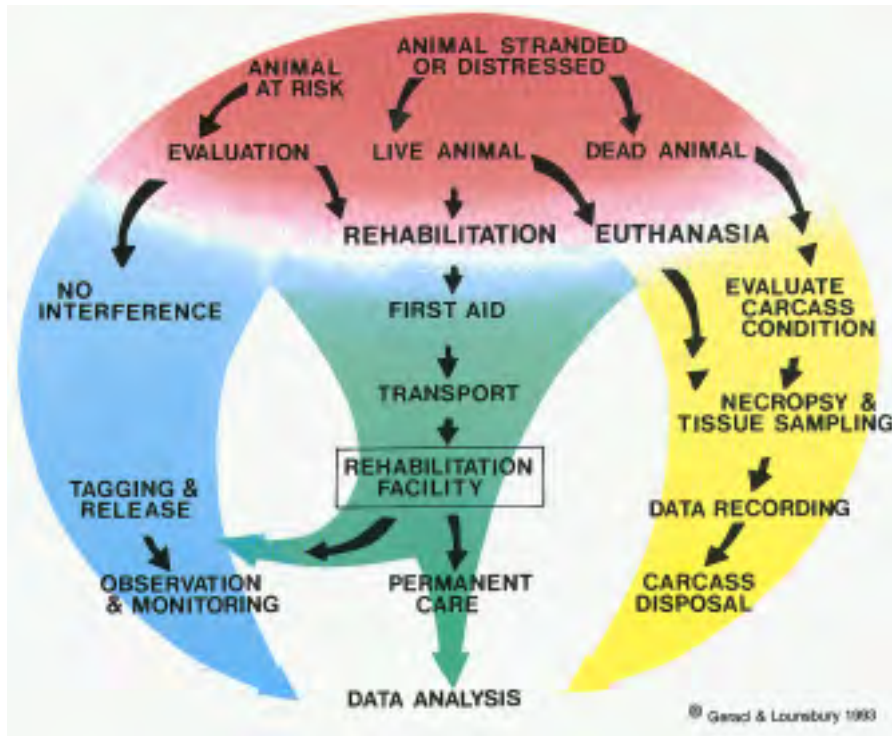


Fig. 5.2. Options for responding to stranded pinnipeds.

Following the general pattern of mortality, **first-year pups are the most likely to strand**. Most come ashore during the nursing period or soon after, particularly when that activity is interrupted by storms or other disturbances. Because their nursing period is brief, maternally dependent phocid pups appear over the course of only a few days or weeks, whereas otariid pups rely on their mothers much longer and are more apt to suffer from any disruption of the mother-pup bond. The frequency of pup strandings tapers off after weaning, through a phase where individuals may appear with residual illnesses stemming from their early days on the rookery. Juveniles and adults come ashore for myriad reasons, with little predictable pattern, except for increased strandings that are associated with a fleeting incident such as a storm, or that signal the onset of an epidemic or toxic event.

## 5.4. Stranding Response

### Jurisdiction

Pinnipeds are protected in U.S. waters by the Marine Mammal Protection Act of 1972. In addition, the Endangered Species Act of 1973

applies to the Hawaiian monk seal, Guadalupe fur seal, and Steller sea lion. Walruses are managed under the jurisdiction of the U.S. Fish and Wildlife Service, and all others by the National Marine Fisheries Service. Procedures for reporting and handling stranded specimens tend to be individualized and vary from region to region. The Operations Center (see 2.3) establishes a cooperative agreement with the responsible federal agency and carries out rescue, rehabilitation and release programs with the agency's approval or direction.

### **Evaluating the Event**

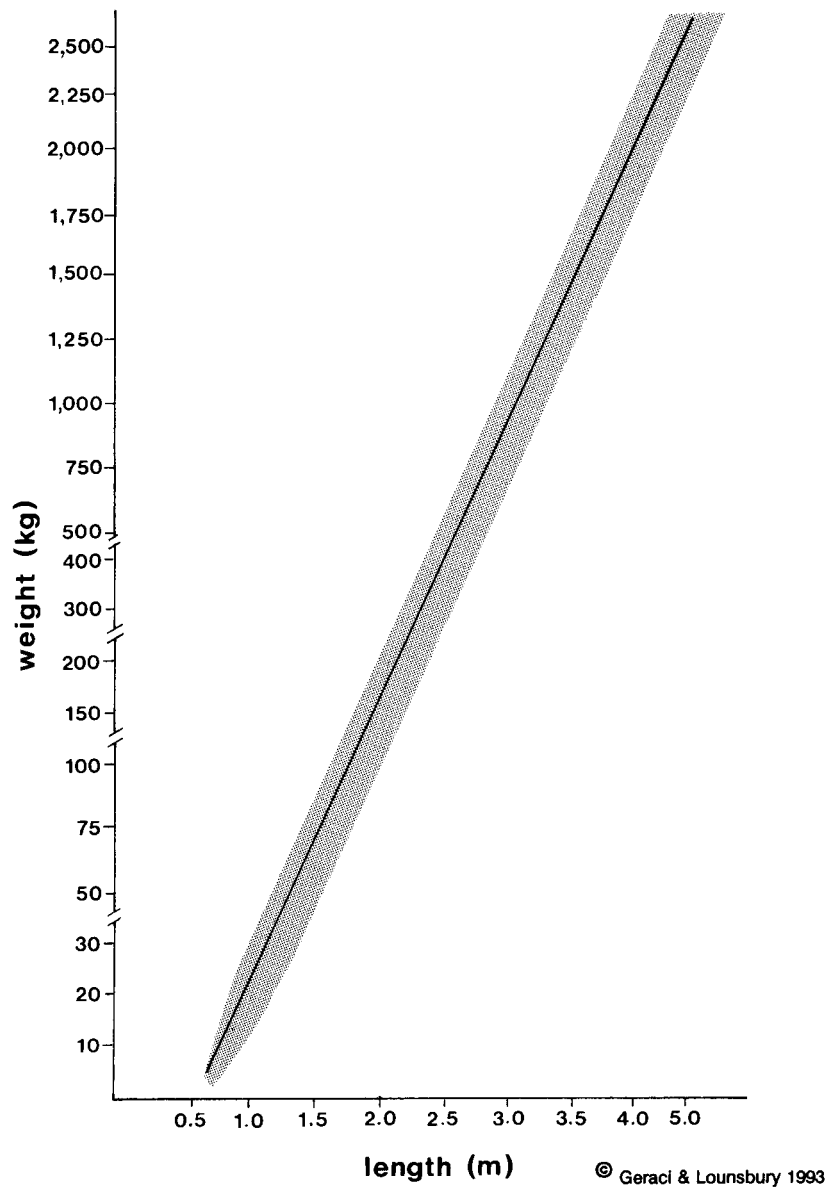
**A pinniped that does not eventually retreat or return to water when approached is either accustomed to such annoyance, naive (as many pups are), or stranded and in need of help.** When in doubt, assume first that the animal is healthy, and continue observations for at least one tidal cycle. Meanwhile, evaluate the reasons a pinniped normally hauls out: mating, pupping, resting, molting. Then consider whether the place, time and season are appropriate for such activities. Might the seal be fatigued during a long migration or after a storm? Is the pup abandoned or will its mother return to resume nursing? While deliberating, the only appropriate action is to protect the animal from disturbance. Sometimes it is necessary to rescue a healthy animal from a perilous setting such as a roadway, or when it is well outside its normal range.

**Too many perfectly healthy pups are inappropriately carried away from shore.** Newborns, because they are thin, feeble, cry plaintively and trail a short umbilical stump, might appear distressed. But most will have an anxious mother waiting nearby and do not need human assistance. Resist the urge to intervene until it is certain that action is required.

More than one or two ailing pinnipeds on the beach simultaneously might be the first sign of a toxic event or outbreak of infectious disease. Until a precise diagnosis is made, assume the latter and take steps to protect the team from unnecessary exposure to pathogens (see 12.2).

### **Specific Equipment** (see also 2.5)

Much of the equipment required for pinniped strandings is geared to capturing and moving animals. Any animal beyond the size of a harbor seal or young sea lion will require heavy equipment. Refer to Fig. 5.3 for help in estimating an animal's weight. Useful items for capture, handling and transport include:



**Fig. 5.3.** This graph can be used to estimate the weight of a pinniped of any given length. Derived from literature sources used to prepare section 5.12, it is based on average to maximum size and represents species occurring in North American waters. **NOTE: This information is not to be used as a guide for administering medications or anesthetics**, as many stranded animals are emaciated and fall far below this average range, while others, such as pregnant females and well-nourished pups, may be above it.

pole/hoop nets	pole noose
tangle nets	cages (various sizes)
jute bags	rope
blankets or towels	ice
herding boards (3 or more)	water-sprayers
4-wheel drive vehicles with bumper winch	
heavy welder's gloves	

**Note:** equipment for dead and sick animals should be used only for that purpose.

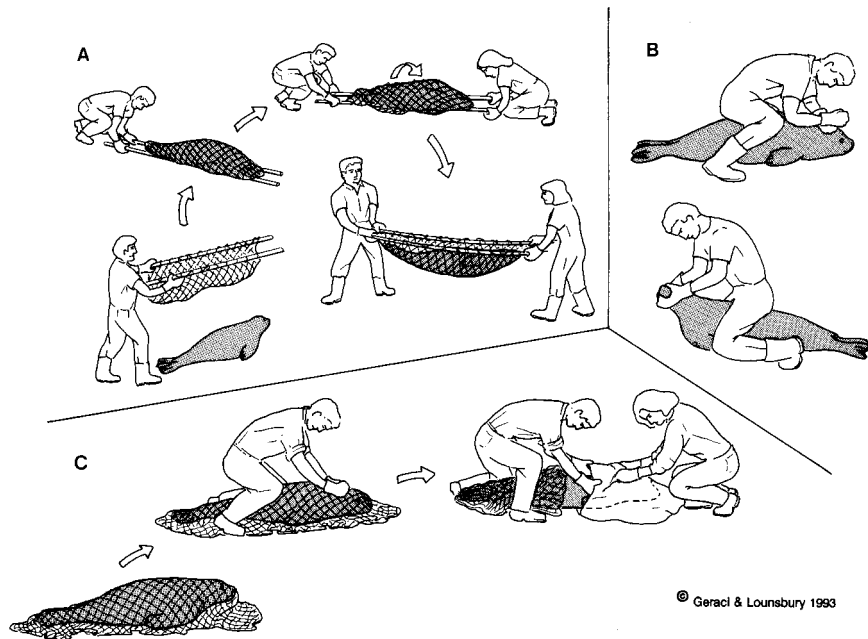
### 5.5. Approach and Handling

Unweaned pups that are sick and abandoned can generally be caught and restrained without difficulty. Animals truly in need of help will not shy away from an approaching rescuer. In fact, some pups are quite aggressive and may bite, if only with their budding teeth. Young specimens can be corralled and secured with a net or pole noose (Fig. 5.4 and 5.5), blanket, or even items of clothing for placement into a transport carrier. If necessary, a small seal can be chased into a clean plastic trash can, using the lid for herding (or as a visual barrier) and the handles for carrying it over rough terrain<sup>74</sup>. Pups, for their small size, are deceptively heavy and difficult to grasp by hand. Consider this when planning the rescue strategy.

Older animals may frighten easily and retreat to water when approached. **Always advance slowly and quietly, keeping a low profile** by crawling, if necessary, and hiding from view as much as possible.



Herding boards (Fig. 5.5) can double as a shield for this purpose. Position teammates in locations where they can distract the animal's attention from approaching persons and block any avenue of escape back into the water. A carefully planned quiet advance will likely be more successful than a military-style assault, except for



**Fig. 5.4.** Capture and handling phocid seals. **A.** Use of net stretcher in capture. **B.** Physical restraint suitable for small phocids. **C.** Capture and restraint involving throw net, physical restraint, and covering head.

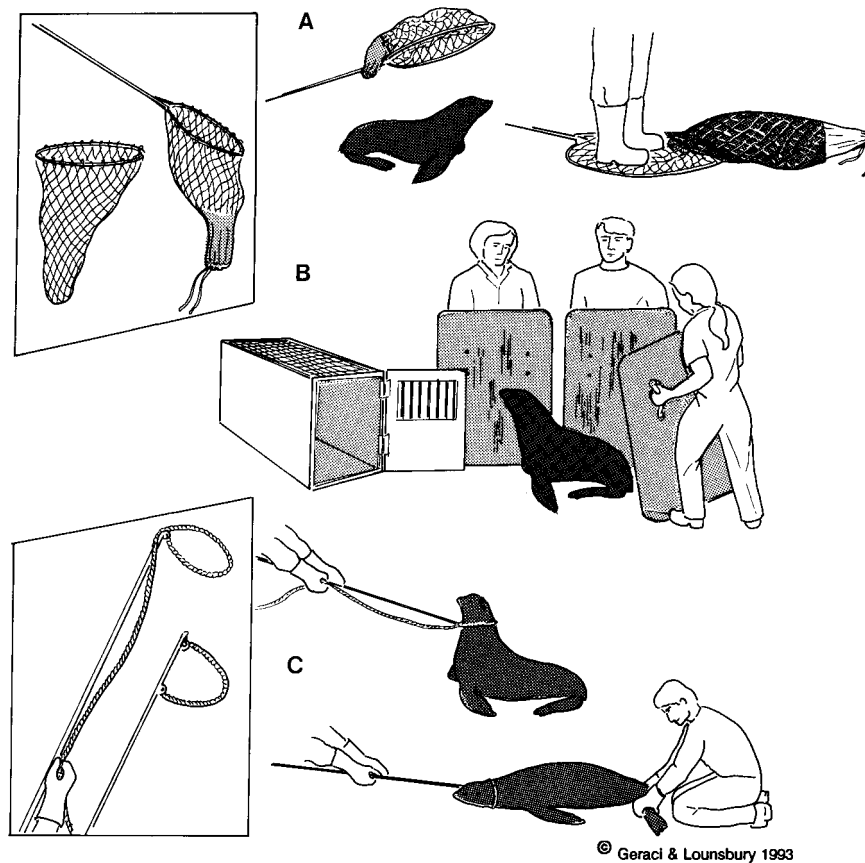
animals that are too helpless to resist any approach at all.

Handling pinnipeds requires skill and common sense<sup>40,43</sup>. Proceed with the certainty that **they can bite** and, when cornered, may become frightened and attack, injuring rescuers or themselves. Large animals such as gray seals, hooded seals and sea lions can inflict serious bites and other injuries, and may go out of their way to do it. Herding boards provide some security, but an aggressive animal can take swift advantage of a small opening or a moment of inattention. Personnel must wear heavy clothing, boots and gloves. Bite wounds from animals should be treated immediately to avoid infection (see 12.2).

Phocid seals can be managed with stretcher nets, throw nets, and hoop nets. Thereafter, a smaller animal can be restrained by one or two people straddling it and securing the head with both gloved hands placed firmly around the neck (Fig 5.4). Use as little force as necessary; a small seal can suffocate under the weight of a handler, especially if rocks or sticks are pressing into its thorax. One strategy for moving a large passive seal (up to 135 kg) is to roll it in a large blanket and onto a stretcher for removal to the transport vehicle. There, it is transferred to a cage and the blanket removed immediately<sup>74</sup>.

Small otariids can be handled like phocid seals. Large ones, because of their agility and speed, are more difficult to capture and restrain, and several people may be required to close in and block the escape route with herding boards. A large specimen on a sandy beach can then be caught with a pole net and herded into a cage. If the terrain or other obstacles will interfere with the rescue, it may be necessary to frighten the animal back into the water, presuming it will re-strand in a more accessible place<sup>74</sup>.

The door of a typical transport cage is usually too narrow for easy entrance by a stranded animal unaccustomed to the procedure. Boxes can be designed specifically for capture by incorporating such features as an opening at each end with drop-in doors that will encourage the



**Fig. 5.5.** Capture and handling otariids and large phocids. **A.** Capture of small otariids with hoop nets (inset). **B.** Use of crowding boards to maneuver animal into cage. **C.** Capture with pole noose (inset) and restraint of hind flippers.

animal to enter, believing it has an escape route at the other end. A seal can also be herded into a box that can then be turned upright and covered with a lid. A small plastic sheet (such as those sold for snow sledding) can be used to slide heavy wooden cages along sandy beaches.

Some pinnipeds become agitated by the capture procedures. **A hood of dark cloth, towel or blanket, or a moistened jute bag placed over the animal's head may induce calming** (not appropriate for gray or hooded seals) and thereby help avoid injury to both animal and handler. Harp seals often become stuporous and virtually freeze in place when approached closely, and remain so while being handled.

Calming beyond these simple measures requires chemical immobilization<sup>37</sup>, which is always risky. Apart from the usual problems encountered when sedating or anesthetizing pinnipeds, there are the added complications of accurately judging the weight, the thickness of blubber that the needle must penetrate, and the health of the subject. Chemical immobilization must be carried out only by qualified individuals.

## 5.6. First Aid

### Determining Condition

The criteria for determining an animal's health depend largely on the physical appearance and behavior as seen by the experienced eye. A clear decision can be made for an animal that is unresponsive, emaciated, injured, or exhibits other disorders such as weakness, rapid or open-mouth breathing (normal breathing rate 3 to 6 breaths/minute), coughing, or nasal or eye discharges<sup>43,109</sup>. Such animals should be prepared for transport to a care facility with no further attempt on the beach to determine the nature of the ailment.

### Supportive Measures

Once the decision has been made to intervene, the best approach is to **remove the stranding from the beach as quickly as possible**. Little can be done on site to bring relief to a pinniped from the probable condition that brought it ashore, except cutting away netting or other marine debris. Even treating lacerations will require procedures that are better carried out in a rehabilitation center. A pressure pack to reduce profuse bleeding should be attempted only when the subject is passive enough to tolerate the procedure.

While awaiting transport, keep the animal cool (with water or ice) and sheltered from warm temperatures, direct sun and blowing sand. In

freezing or sometimes even temperate weather, a thin animal may require protection against hypothermia; one might consider using a blanket to cover a scrawny pup.

### 5.7. Immediate Release

Candidates for immediate release include healthy seals that may have strayed too far inland or have come ashore entangled in debris but uninjured. Ordinarily, any seal that is stranded due to injury or illness is fit for release only after rehabilitation.

Releasing a pinniped usually involves little more than opening a cage door at a suitable shoreline site. Remote beaches near haul-out sites occupied by others of the same species are preferred. Let the animal enter the water of its own accord, and it will probably swim away before long. Pinnipeds need no assistance orienting themselves; **it is unnecessary, and also dangerous, to enter the water with an animal**

All animals should be tagged before release (see 5.10), and the location and time of release noted along with other life history data as part of the animal's permanent record.

### 5.8. Transport to Care Facility

Transport cages must be large enough to allow an animal to stretch to its full length, raise up its head, and turn around. Some of the more aggressive species, such as hooded seals, are better off in smaller quarters. The cage must be designed to permit free air circulation and prevent contact with wastes. Containers, whether of wood, plastic or metal, should have openings small enough to discourage the animal from biting the caging material (or anyone near it) and thus damaging its mouth, but large enough to allow periodic wetting or the addition of ice for drinking and cooling. The cage door must be secure to prevent escape; never underestimate a seal's ability to out-fox its rescuer.

Road vehicles are usually involved in a transport, if only to move the stranding to and from other means of conveyance. Small pups can be carried in the back seat of a car, though not all family members will appreciate the lingering evidence. Any vehicle must provide protection from direct sun, heat, wind and freezing temperatures (aim for a temperature of 10° to 20°C). Prevent the entry of exhaust fumes, such as those that may occur in the back of an open truck, or their build-up in an enclosed vehicle. Secure the cages to minimize shifting and jolting, and include equipment for appropriate on and off transfer of animals by hand, forklift, or crane. When renting a vehicle, select one with air shock



absorbers (“air-ride suspension”) and a hydraulically operated lifting platform at the rear. Keep noise and commotion to a minimum, and provide drinking water during layovers.

**Well-insulated pinnipeds are prone to overheating** and must be closely observed for signs of hyperthermia during transport. Stereotypic behavior, such as incessant movement, will also compound the problem. Plan the transport so animals are not kept in cages unattended for longer than 2 to 4 hours during any leg of the journey. Interrupt the transport at these intervals to refresh the animal by dousing it with water.

## 5.9. Rehabilitation

### General Considerations

The physical and organizational needs of a rehabilitation center are substantial if the facility hopes to accommodate the spectrum of health conditions in the stranded population. More than a collection of cages, pools and haul-out decks, a rehabilitation center must provide for emergency treatment, nutrition, surgery, quarantine, chronic care, and raising orphaned pups. Operations can be expected to continue around the clock. It also serves as a halfway house where seals are conditioned for eventual release, and as a research laboratory where information is gathered on ways to continually improve standards of care.

**No beach resident or even satellite facility has the resources to rehabilitate a stranded pinniped**, short of one that may simply need to be freed from an entangling net. Yet pinnipeds, more than any other marine mammal, are likely to find themselves in temporary holding quarters while arrangements are made to ship them. During this time, the only practical measures are to provide for the animal’s comfort by sheltering it from the elements, minimizing stress from unnecessary handling and disturbance, isolating it from domestic animals, and giving access to fresh water for cooling and drinking.

At the rehabilitation center, strandlings should be weighed and given a preliminary visual examination. A more detailed clinical evaluation, including hematology, plasma chemistry and parasitological and microbiological screening<sup>25,43,55,109</sup> can wait up to 24 hours until the animal has recovered from the stress of capture and transportation. Even then, diagnostic indices such as respiratory and heart rates and body temperature may be misleading. As an example, some phocids become “cataleptic” and stop breathing entirely for a minute or two when restrained. Uncooperative animals can make visual inspection of mu-

cous membranes a challenge. Never force the eyelids open for close examination, as this risks damage to the cornea.

Pinnipeds that are candidates for rehabilitation are usually malnourished and dehydrated, regardless of age. Treatment usually begins with or includes therapy to restore fluid and electrolyte balance. Early critical care is also directed toward hypo- or hyperthermia, injuries and infections. When dealing with highly contagious pathogens, special attention is required to protect animal handlers and other strandlings from infection. The rehabilitation center must have veterinary and support staff prepared to deal with all of these conditions.

### Nutrition

Strandlings are generally divided into two categories depending on their nutritional needs: premature and orphaned pups; and subadults and adults. Pups need special diets and feeding regimes, and many different formulas and approaches have been used successfully<sup>3,29,104</sup>. When a phocid pup in good condition arrives at the New England Aquarium, it is given several feedings of 100 to 200 mL each of saline or water. After 24 hours, the fluids are replaced with the same quantity of a dilute special formula that is gradually changed to full formula over the next 2 days. The pup is weaned onto fish within 4 to 5 weeks. Pups should be weighed at the same time each day. Aim for a target weight, usually taken as the weight at weaning of a free-ranging pup of that species (see 5.12).

California sea lions (and other otariids) normally nurse for a considerably longer period, up to 6 to 12 months of age. However, hand-reared pups can be weaned within a few weeks or months on formulas similar to those used for phocids—often with the addition of blended fish<sup>104</sup>.

Adult pinnipeds thrive on a mixture of good quality fish such as herring and smelt<sup>43,62</sup>. Pup formula can also be used to nourish older animals during the initial phase of critical care, but the process is time-consuming, expensive, and is only practical when dealing with one or two individuals. Part of the problem is that the formula must be given by stomach tube, a procedure most adults will resist. As soon as possible, replace formula with a gruel of ground fish, water and supplements. Better still, offer whole fish, which the animal can take on its own. Those that refuse may be force-fed, but this is difficult to do and dangerous for the attendant. It may be necessary to use a mild sedative on an aggressive seal when no safe option is available, but as a routine, force-feeding adults is impractical. **An adult that will not eat can be impossible to deal with.**

### Disease and Injuries

Virtually every new arrival harbors microorganisms that are normally harmless but can cause disease when the animal is weak or stressed; pneumonia, for example, is common. For that reason, the veterinarian will probably place apparently healthy pups and other strandlings on a program of preventive antibiotic therapy. A few microorganisms are inherently pathogenic (e.g., *Leptospira*, influenza virus and morbillivirus), and infected animals must be isolated from all others in the facility. Because time and special techniques are required to identify these infectious agents, **all new arrivals should be quarantined while health assessments are made.**

**Parasites alone seldom debilitate otherwise healthy pinnipeds, but can harm stranded animals weakened by other conditions** Nematodes in the stomach and lungs can cause ulcers and pneumonia. Some stranding centers treat for parasites on a broad scale; others select specific cases for treatment. What is certain is that nearly every animal beyond the age of a newborn, and sometimes even those<sup>36</sup>, will have parasites.

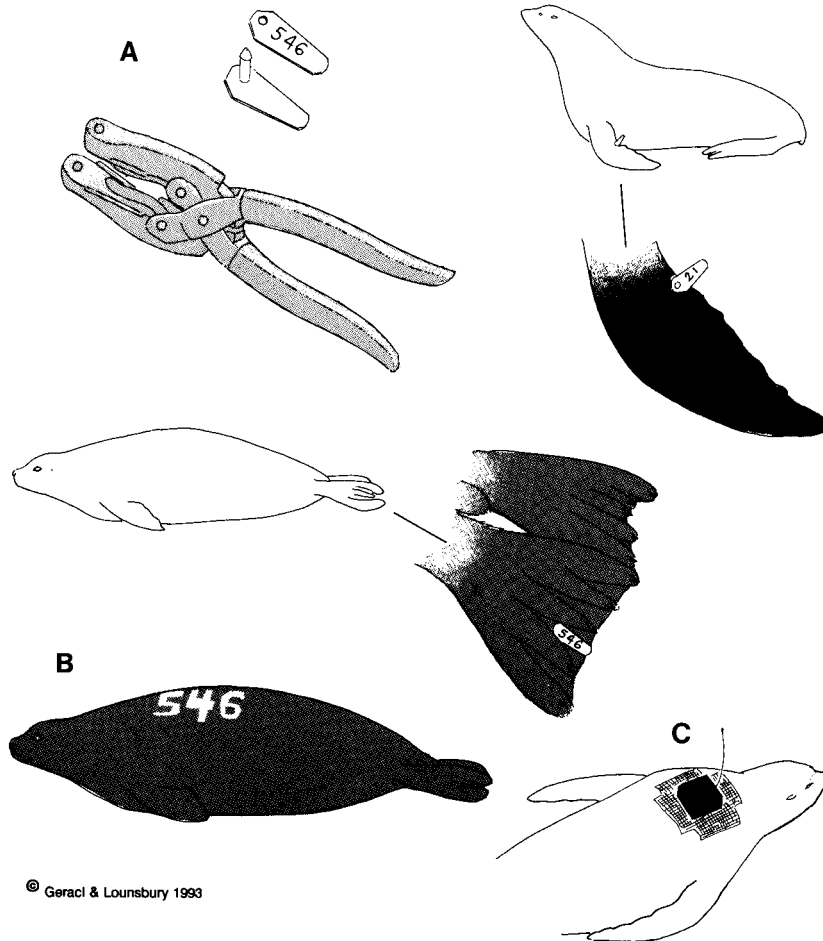
Pinnipeds sometimes arrive ashore with serious injuries, many caused by shark bites or net entanglement. Wounds to soft tissue and bone can be extensive and take months to heal. This category of animals usually requires an abiding commitment to long-term (sometimes permanent) care on the part of the center.

## 5.10. Release Following Recovery

### Criteria

**A pinniped should be released only when there is reasonable expectation that it will survive and lead a normal life** The candidate must be healthy, well-nourished, free of transmissible disease, coordinated and active; able to forage, detect and escape predators, and contend for a suitable niche among others of its species. An ideal program would prepare animals for life in the wild (complete with a transition to live prey), but on a large scale, this is costly and impractical. At the very least, caretakers strive to reduce human dependence while encouraging the animal to socialize with its own kind. Adopt the basic rule: **do not treat candidates for release as pets.**

The timing of the release should be synchronized with seasonal or annual cycles in the wild population. Most pinniped species have inshore-offshore or north-south movements or migrations that are linked with environmental conditions such as food availability and oceanic



© Geraci & Lounsbury 1993

**Fig. 5.6.** Some techniques for tagging pinnipeds. **A.** Plastic cattle ear tags are commonly used<sup>40,67,100</sup>, easy to apply with special pliers, and have a long retention time. Tags are attached to the hind flipper of phocids (between the third and fourth digits) and to the foreflipper of otariids. Rounding the point on the male half of the tag before application will help reduce subsequent irritation. A disadvantage of this tag is its small size, making resighting difficult. **B.** Marking with dye (such as lanolin-based sheep dye, human hair dye), quick-drying paint, or peroxide bleach<sup>67</sup> on the top of the head or back is fast and harmless (be careful of the eyes). The marks are highly visible, last until the next molt, and are suitable for short-term observation. **C.** Radio transmitters (satellite or VHF) can be mounted on a mesh base which is attached with marine epoxy to the fur of the back between the shoulders, or on the top of the head. These tags will be lost when molt occurs. (Additional references: Laws, R.M. 1952. Seal-marking methods. *The Polar Record* 6: 359-361. Loughlin, T.R. 1973. Harbor seal (*Phoca vitulina* L.) distribution and capture technique in Humboldt Bay, California. Tenth Annual Conference on Biological Sonar and Diving Mammals.)

temperatures, as well as with breeding or molting cycles. Current U.S. regulations address this biological reality by stipulating that animals should be returned at a time and place appropriate for the species. (See *also 5.7.*)

### **Observing and Monitoring**

**Marking or tagging a released animal (Fig. 5.6) is the only reliable way to know where it is and how long it survives**, and allows a means of identifying one that restrands. Tagging animals that marginally meet the criteria for release will provide additional information that will eventually help to establish new standards. Monitoring studies add yet another element of cost to the stranding program but are nonetheless fundamental to the entire operation. Stranding centers increase the monitoring efficiency by focusing resources on an intensive surveillance of a few animals rather than a superficial attempt on many.

### **5.11. Euthanasia**

Euthanasia can only be carried out by a trained individual under the authority of a qualified veterinarian. This is usually accomplished by lethal injection of barbiturates or other agents normally used to euthanize domestic species. On the beach, adult male sea lions or elephant seals with obviously serious injuries are best dispatched by gunshot, providing it is safe to do so. The procedure is usually carried out by discharging a high-velocity bullet into the brain; the technique requires skill, training and legal authorization for the weapon.

### 5.12. Pinnipeds in U.S. and Adjacent Waters: A Brief Guide to Species Identification, Life History, and Stranding Frequency

Note: Descriptions and life history data were taken from general references<sup>63,95</sup> and selected reports for each species.

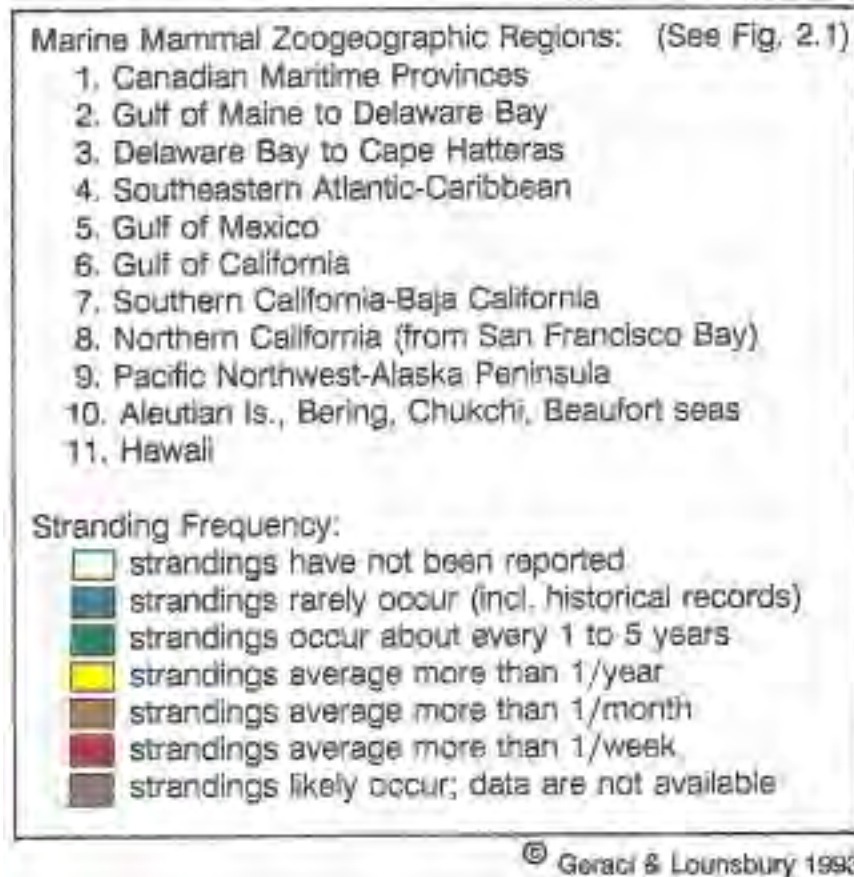


Fig. 5.7. Marine mammal zoogeographic regions in U.S. and adjacent waters and color key to stranding frequency.

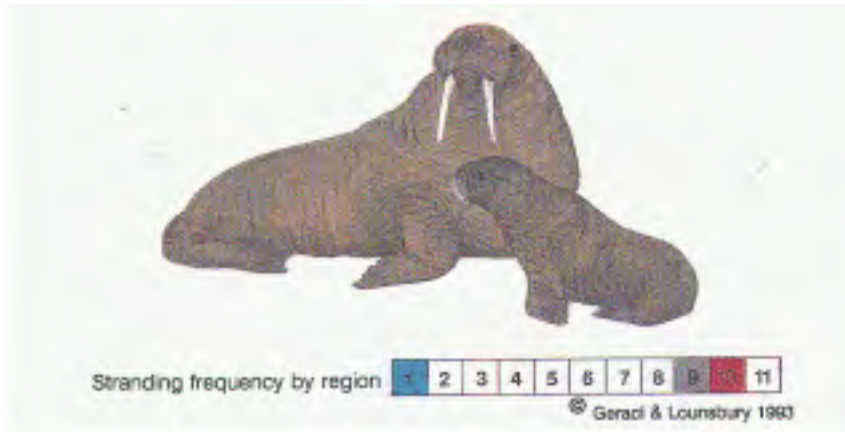
**Order Carnivora**  
**Suborder Pinnipedia**

**Superfamily Otarioidea**

Includes the Otariidae (sea lions and fur seals) and the Odobenidae (walruses); the hind flippers can be rotated forward; females have 4 mammary teats.

**Family Odobenidae (Walrus)**

General characteristics: ear opening obvious, but without external pinna; testes in inguinal region, between blubber and abdominal muscles.



**Walrus (*Odobenus rosmarus*)**<sup>31,32,70,72,99</sup>

**Range:** **1** (northern, winter); **2** (northern, occasional); **10** (north of Bering Str. summer and autumn only; main breeding areas, Bering Sea).

**Size:** 1.0-1.4 m, 35-85 kg (neonate); 2 m, 350 kg (weaning); 2.3-2.6 m, 560-1000 kg (adult female); 2.7-3.2 m, 900-1600 kg (adult male)

**Distinguishing**

**features:** Squarish head with large moustachial pad and many short stiff vibrissae; enlarged upper canines (tusks); thick, wrinkled skin with short hair; tail contained in fold of skin. Teeth: I1/0, C1/1, PC3/3 each side.

**Habits:** Highly gregarious; females and young mostly segregated from adult males in nonbreeding season; calving Apr.-June; molting June-Oct.; coastal to offshore on sea ice, using shore haulouts in summer and autumn.

### Family Otariidae (Fur Seals and Sea Lions)

General characteristics: body form generally slender with long neck; small ear pinna present; foreflippers long, hairless in most species, with rudimentary nails set back from tips of digits; testes scrotal. Teeth: I3/2, C1/1, PC5/5 or 6/5 each side.



**Steller sea lion** (*Eumetopias jubatus*)<sup>7,32,52,70,85,94,96,97,98</sup>

**Range:** 7; 8; 9; 10 (Aleutian Is. and Bering Sea); breeding range from Pribilof Is. to central California (Año Nuevo Is.).

**Size:** 1 m, 17-23 kg (neonate); 2.2-2.7 m, 260-330 kg (adult female); 2.8-3.0m, 560-800 kg (adult male).

**Distinguishing**

**features:** Pelage with sparse underfur; gap between 4th and 5th postcanines; color light tan to reddish brown, pups darker brown; pronounced sexual dimorphism; adult males with moderately developed sagittal crest, more muscular neck with mane of longer hair; roar-like vocalizations.

**Habits:** Coastal to pelagic; gregarious year-round; pupping May-July; haul-out sites and rookeries on land; often on land outside of breeding season.





**California sea lion** (*Zalophus californianus*)<sup>7,8,24,81,85,97,98</sup>

**Range:** 6; 7; 8; 9 (to Vancouver I., mostly males); primary breeding range from Channel Is. southward to central Mexico.

**Size:** 0.7 m, 5.5-6.4 kg (neonate); 25 kg (weaning); 1.5-1.8 m, 50-110 kg (adult female); 2.0-2.3 m, 250-300 kg (adult male).

**Distinguishing**

**features:** Pelage with sparse underfur; no gap between 4th and 5th postcanines; color dark brown, juveniles and females lighter; extreme sexual dimorphism, males with prominent sagittal crest, more muscular neck; sharp bark-like vocalizations.

**Habits:** Coastal, entering estuaries; rookeries and haul-out sites on land; pupping May-June; gregarious year-round; often on land in mixed groups outside breeding season.



**Northern fur seal (*Callorhinus ursinus*)**<sup>24,32,38,70,85,97,98,115</sup>

**Range:** **7** (San Miguel I. year-round); **8-9** (winter-spring, offshore); **10** (summer-fall); breeding areas, Pribilof Is. and San Miguel I.

**Size:** 0.7 m, 4.5-6 kg (neonate); 12-14 kg (weaning); 1.3-1.6 m, 35-60 kg (adult female); 1.9-2.3 m, 185-275 kg (adult male).

**Distinguishing**

**features:** Pelage with coarse outer guard hairs and soft, dense underfur; fur on foreflipper stops at wrist; snout short, down-curved and pointed; males brown, females dark gray and lighter gray or chestnut ventrally; neonates black; extreme sexual dimorphism, adult males with massive neck and bushy mane.

**Habits:** Coastal to pelagic (offshore in winter); migratory; rookeries on offshore islands; pupping June-Aug.; rarely on land (and nongregarious) outside of breeding season.





**Guadalupe fur seal** (*Arctocephalus townsendi*)<sup>3,24,98</sup>

**Range:** 7 (Channel Is. to Cedros I.; breeding on Guadalupe I. only).

**Size:** 0.6 m (neonate); <2 m, 140 kg (adult male); female smaller.

**Distinguishing**

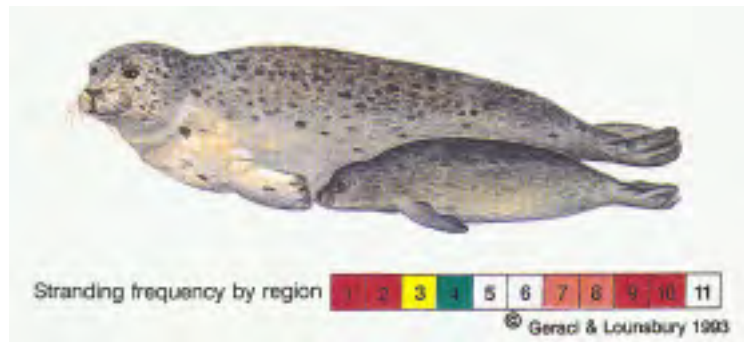
**features:** Pelage with dense underfur; fur on forelimb extending onto flipper; snout long and pointed; color grayish black.

**Habits:** Coastal, preferring rocky areas and caves; rookeries on land; gregarious; pupping June.

### Family Phocidae (Hair Seals)

General characteristics: body fusiform and rotund, with short, thick neck; pinna absent; hind flippers cannot rotate forward; flippers with hair on both surfaces; claws at tips of flippers; testes in inguinal region, between blubber and abdominal muscles; 2 or 4 mammary teats. Teeth: I2-3/1-2, C1/1, PC5-6/5 each side.

**Phoca spp.:** general characteristics include hind flipper with 1st and 5th digits slightly longer than middle three; foreflipper with 1st and 2nd digits longer than third; two mammary teats; vibrissae beaded, slender and curled; forehead with concave profile and short snout; eye closer to tip of nose than to ear opening; nostrils forming V-shape; sexes of nearly same size; neonates usually with white lanugo.



**Harbor seal (*Phoca vitulina*)**<sup>5,6,8,10,24,30,53,82,84,97,98</sup>

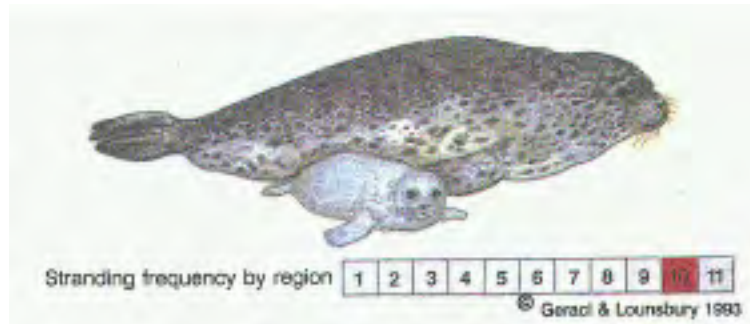
**Range:** 1; 2; 3 (occasional); 7; 8; 9; 10 (Aleutian Is., Pribilof Is., Bristol Bay); breeds throughout most of range (north of New Hampshire on Atlantic coast).

**Size:** 0.7-0.9 m, 9-15 kg (neonate); 0.9 m, 20-27 kg (weaning); 1.5-1.8 m, 75-120 kg (adult).

#### Distinguishing

**features:** Snout blunt; color variable (gray to tan to brownish-black, with darker spotting); pups gray to tan (white lanugo may be shed after birth in northern populations); pelage on back smooth to touch. Teeth: I3/2, C1/1, PC5/5 each side.

**Habits:** Coastal year-round, entering rivers and some lakes; commonly haul out on land, sandbars and ledges at low tide; form casual small to large groups; pupping season varies with latitude (May-June area 1, Mar.-May area 2, Mar.-June areas 7-8, May-July area 10); molt varies with latitude, occurring 2-3 months after pupping season.



**Spotted seal (*Phoca largha*)**<sup>6,13,32,70,86</sup>

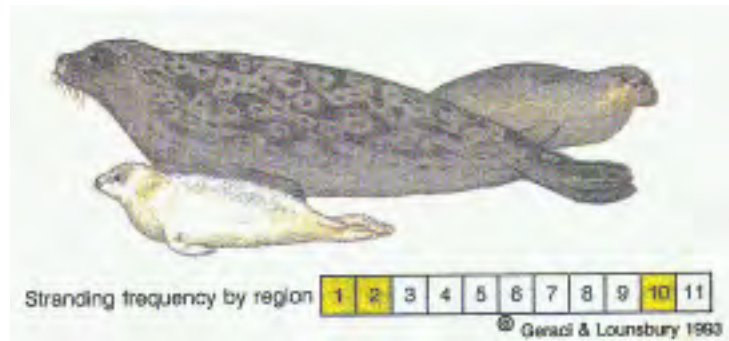
**Range:** 10 (winter-spring, along ice front; summer, Bering and Chukchi seas); breeds along ice front.

**Size:** 0.8 m (neonate); 1.5-1.6 m (adult).

**Distinguishing**

**features:** Similar to harbor seal; belly light silver-gray, back and head darker and marked with silver rings, brown to black spots scattered over body; neonates with white lanugo. Teeth: I3/2, C1/1, PC5/5 each side.

**Habits:** Solitary or form small groups on ice; groups to 2000 or more on summer land haulouts; pupping and molting haulouts on pack ice; pupping March-April, molt May-June.



**Ringed seal (*Phoca hispida*)**<sup>30,32,56,70,78,84,103</sup>

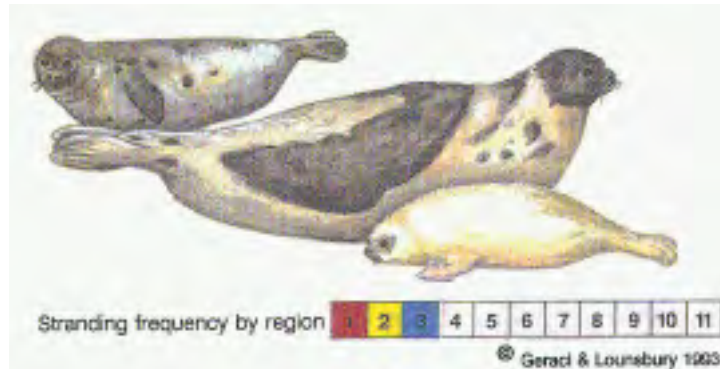
**Range:** 1 (Labrador northward); 10 (Beaufort and Chukchi seas; Bering Sea north of Bristol Bay); breeds over most of range.

**Size:** 0.6-0.7 m, 4-4.5 kg (neonate); 0.8 m, 9-16 kg (weaning); 1.2-1.5 m, 60-100 kg (adult).

**Distinguishing**

**features:** Head narrow with somewhat pointed nose; back dark gray with light rings, belly silver-gray; neonates with white lanugo; older pups dark gray above, silvery below; pelage on back coarse, harsh to touch. Teeth: I3/2, C1/1, PC5/5 each side.

**Habits:** Prefer stable land-fast ice in winter and spring; nongregarious, forming casual groups; pupping mid-March to May in snow-covered lairs; molt from May-July on fast or pack ice.



**Harp seal** (*Phoca groenlandica*)<sup>30,68,84,91,100</sup>

**Range:** 1 (Dec.-May); 2 (uncommon); breeding areas in Gulf of St. Lawrence and off northeast coast of Newfoundland.

**Size:** 0.8-1.0 m, 7-12 kg (neonate); 1.0 m, 30-35 kg (weaning); 1.7-1.9 m; 120-180 kg (adult).

**Distinguishing**

**features:** Dark harp-shaped pattern on back and sides, white to tan background (pattern less distinct in females), dark head; neonates with white lanugo, juveniles gray to tan with darker spots. Teeth: I3/2, C1/1, PC5/5 each side.

**Habits:** Migratory; pupping and molting on pack ice; scattered during breeding, gregarious during migration and molt; pupping late Feb. to mid-Mar., molt Apr.-May.



**Ribbon seal** (*Phoca fasciata*)<sup>13,14,32,58,70</sup>

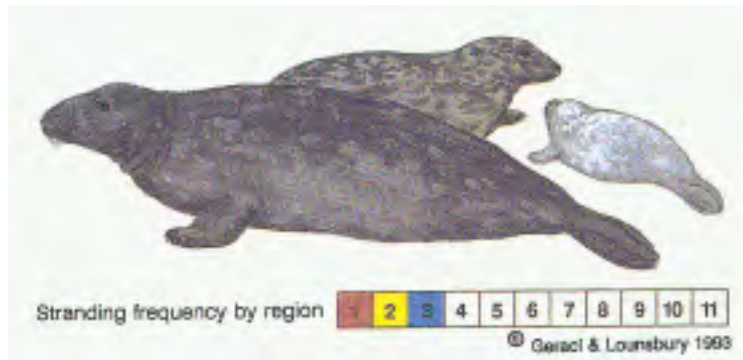
**Range:** 10 (Bering and Chukchi seas; winter-spring, offshore along ice front; summer range unknown); breeds along ice front.

**Size:** 0.9 m, 9-11 kg (neonate); 0.9-1.1 m, 28 kg (weaning); 1.5-1.8 m, 80-140 kg (adult).

**Distinguishing**

**features:** Adult males with white bands on dark brown to black background, females with less distinct bands on lighter background; neonates with white lanugo; juveniles blue-gray on back, paler ventrally. Teeth: I3/2, C1/1, PC5/5 each side.

**Habits:** Pelagic; nongregarious; pupping and molting on pack ice; pupping April-May; molt April-July.



**Gray seal (*Halichoerus grypus*)**<sup>9,30,73,84</sup>

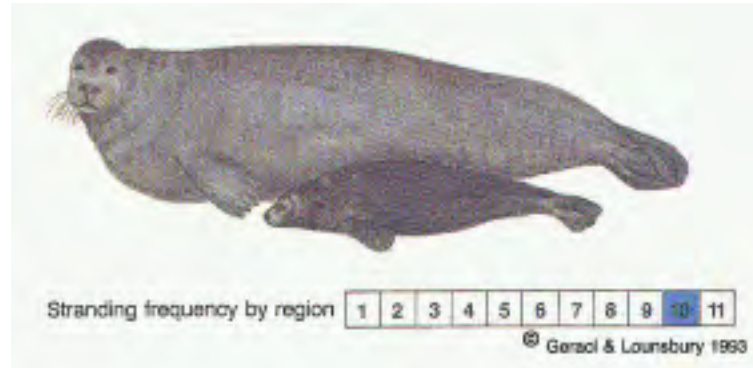
**Range:** 1; 2 (Nantucket Is. northward); breeding range from southern Nova Scotia to Gulf of St. Lawrence and Sable Island, isolated colony on Nantucket Is.

**Size:** 0.8-1.0 m, 11-20 kg (neonate); 1.1 m, 40-45 kg (weaning); 1.8-2.1 m, 100-180 kg (adult female); 2.2-2.4 m, 200-300 kg (adult male).

**Distinguishing**

**features:** Hind flipper with 1st and 5th digits slightly longer than middle three; foreflippers with long, slender, curved nails and 3rd digit shorter than 1st and 2nd; vibrissae beaded, slender and curled; snout long with straight or convex profile; nostrils W-shaped; eye closer to ear than to nose; 2 mammary teats; males distinctly larger than females; pelage coarsely spotted, with dark spots on a tan-gray background in females, and lighter spots on a dark background in males; juvenile coloration less distinct; neonates with white lanugo for 2-3 wks. Teeth: I3/2, C1/1, PC5/5 or 6/5 each side.

**Habits:** Prefer remote exposed islands, sandbars and shoals; feed offshore; pupping (area 1) Jan.-Feb. on islands or land-fast ice; molt May-June.



**Bearded seal** (*Erignathus barbatus*)<sup>13,15,32,57,68,70,84,95</sup>

**Range:** 1 (Labrador northward); 10 (southward to Bristol Bay in winter); breeds over most of range.

**Size:** 1.3 m, 35 kg (neonate); 1.5 m, 85 kg (weaning); 2.1-2.4 m, 230-340 kg (adult).

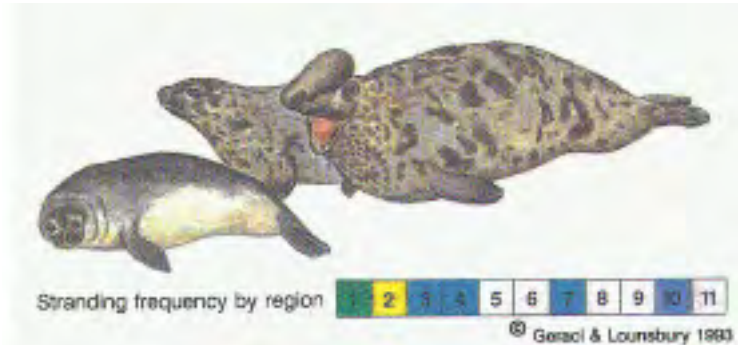
**Distinguishing**

**features:** Hind flipper with 1st and 5th digits slightly longer than middle three; foreflipper broad and squarish with 3rd digit longest; 4 mammary teats; vibrissae smooth, thick, straight and bushy; head proportionately small; back and sides gray, silver-gray on belly; pups grayish brown with irregular light patches; juveniles silver-gray; teeth of adults often worn or missing. Teeth: I3/2, C1/1, PC5/5 each side.

**Habits:** Solitary or form casual groups; pupping March-May; molt May-June; pupping and molting haulouts on pack ice.







**Hooded seal (*Cystophora cristata*)**<sup>16,27,30,68,82,84,88</sup>

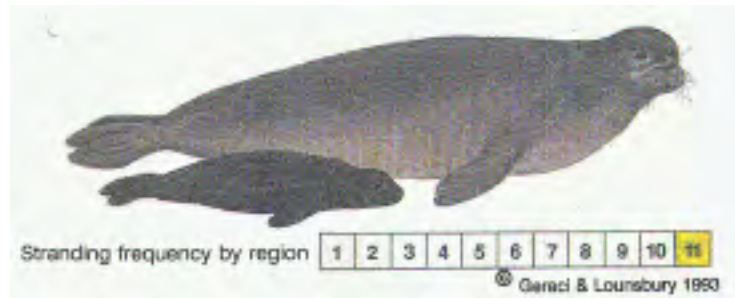
**Range:** 1 (Dec.-Apr.); 2 (occasional); breeding areas in Davis Str., Gulf of St. Lawrence, and off northeastern coast of Newfoundland.

**Size:** 0.9-1.1 m, 15-30 kg (neonate); 2.0-2.2 m, 150-300 kg (adult female); 2.3-2.7 m, 200-375 kg (adult male).

**Distinguishing**

**features:** Hind flipper with 1st and 5th digits much longer than middle three; adult males with inflatable hood extending from crown of head to upper lip, and inflatable nasal sac; adult males larger than adult females; 2 mammary teats; body gray with irregular black patches, face dark; neonates blue-gray on back, white on belly, with dark face. Teeth: I2/1, C1/1, PC5/5 each side.

**Habits:** Migratory; associated with offshore pack ice, area1; occur in small family groups; pupping Mar.-Apr.; molt June-Aug.



**Hawaiian monk seal (*Monachus schauinslandi*)**<sup>60</sup>

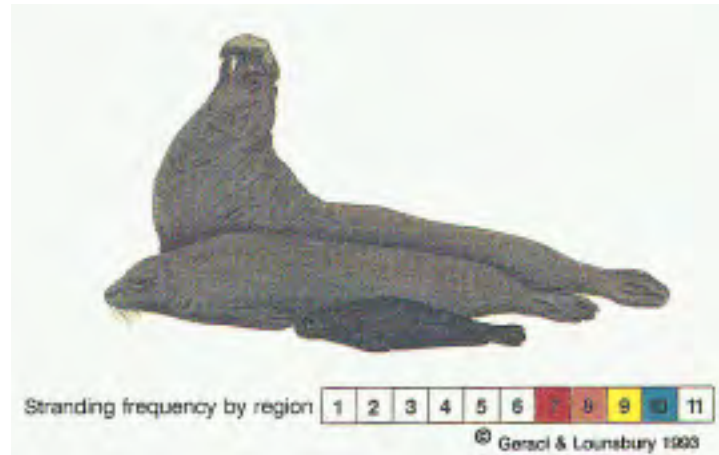
**Range:** 11 (northwestern).

**Size:** 1.0 m, 16-18 kg (neonate); 1.0 m, 56-86 kg (weaning); 2.1-2.2 m, 175 kg (adult male); 2.3-2.4 m, 200-275 kg (adult female).

**Distinguishing**

**features:** Hind flipper with reduced claws, and 1st and 5th digits much longer than middle three; vibrissae smooth; 4 mammary teats; females slightly larger than males; pelage dark gray above, lighter below; neonates black. Teeth: I2/2, C1/1, PC5/5 each side.

**Habits:** Pupping Jan.-Aug., peak March-May; molt May-Sept.; nongregarious; frequently haul out on sandy beaches.



**Northern elephant seal (*Mirounga angustirostris*)**<sup>22,77,85,97,98</sup>

**Range:** 7 (primary range of adult females); 8; 9 (spring-fall, mostly juveniles and males); breeds in area 7.

**Size:** 1.2 m, 30-45 kg (neonate); 135-175 kg (weaning); 2-3.2 m, 900 kg (adult female); 4-5 m, 2000-2500 kg (adult male).

**Distinguishing**

**features:** Hind flipper with reduced claws and 1st and 5th digits much longer than middle three; adult males with inflatable proboscis that may overhang mouth; 2 mammary teats; males larger than females; color gray to brown with no markings; neonates black; adult males with thick, cracked and scarred skin on the neck and chest. Teeth: I2/1, C1/1, PC5/5 each side.

**Habits:** Highly gregarious; feed offshore; pupping and molting haulouts on land; pupping Jan.-Feb., molt May-August.





*Chapter 6*  
**Cetaceans — Single Strandings**

6.1. Biology.....	71
6.2. Mortality.....	76
6.3. Stranding Patterns.....	78
6.4. Stranding Response.....	79
6.5. Approach.....	83
6.6. First Aid.....	83
6.7. Handling, Lifting and Moving.....	88
6.8. Immediate Release.....	92
6.9. Transport to Care Facility.....	97
6.10. Rehabilitation.....	98
6.11. Release Following Recovery.....	100
6.12. Euthanasia.....	100
6.13. Cetaceans in U.S. and Adjacent Waters.....	104
References.....	258

**6.1. Biology**

**Anatomy**

The **Cetacea** are the oldest and most diverse group of marine mammals, with fossil evidence dating back at least 40 to 50 million years. All living families of **toothed** (suborder: **Odontoceti**) and **baleen** (suborder: **Mysticeti**) whales recognized today had evolved by 5-25 million years ago<sup>7</sup>. The Artiodactyla, or even-toed ungulates, are the cetaceans' closest terrestrial relatives<sup>8</sup>.

Cetaceans have fusiform, streamlined bodies, with paddle-like **flippers** used for steering, balancing and stopping, but not for moving forward. That action is powered by both the upward and downward movement of the tail or **flukes**<sup>58</sup>. Most species have a **dorsal fin**, which serves as a stabilizer. The flukes and dorsal fin are mostly composed of dense connective tissue but no bone. Streamlining is aided by the smooth, rubbery skin, generally lacking in glands and hairs, and the absence of protruding ears and hind limbs and, in males, of external genitalia.

Odontocete **teeth** are usually closely spaced, uniform in shape and size, and bear growth rings in cross section that are useful for estimating the age of the animal<sup>91</sup>. Mysticetes have, instead of teeth, a series of **baleen plates** suspended from each side of the upper jaw. Hair-like bristles on the inner edges of these keratinous plates intertwine, forming

a sieve that filters food from the water<sup>97</sup>. The color, number and length of the plates can be used to help identify the species (Fig. 10.16).

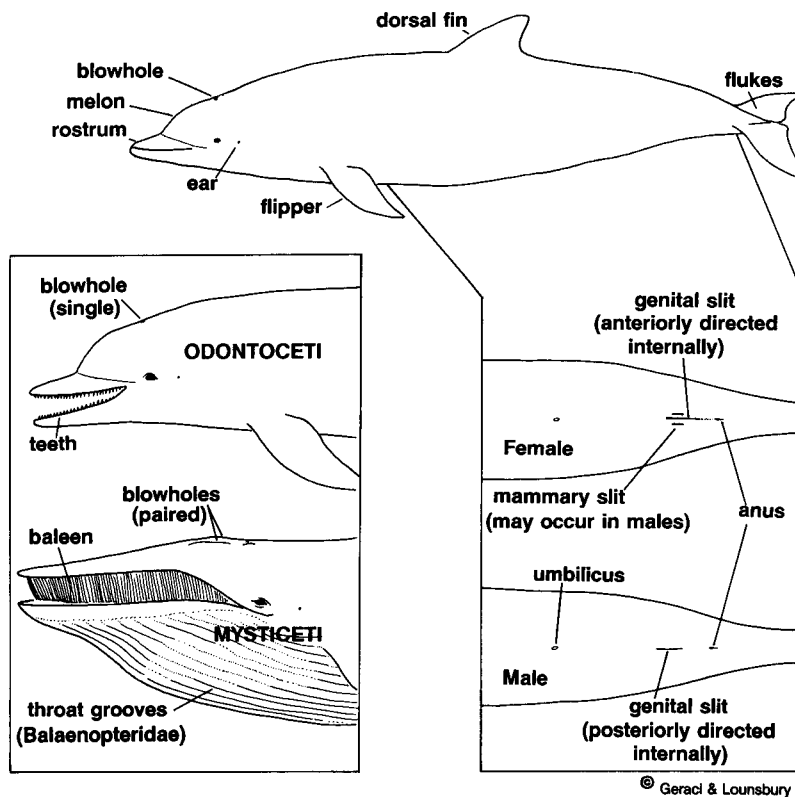
The nose, or **blowhole**, is situated on top of the head, somewhat to the left of the mid-line in odontocetes. The nostrils are paired in mysticetes and single in odontocetes. The nasal passages of the latter contain an interconnected series of **air sacs** that are involved in sound production<sup>74</sup>. A unique arrangement of the larynx allows odontocetes to swallow and breathe at the same time. The lungs are symmetrical, without external lobulation, and turgidly elastic; the pleura is unusually thick and well-vascularized<sup>62,126</sup>. There is a well-defined lung-associated lymph node.

The **cardiovascular system** has a unique adaptation of arteries and veins, known as the **periarterial venous rete**, which helps the animal regulate body temperature. Each artery at the surface (particularly evident in the flukes, flippers and dorsal fin) is surrounded by a network of veins, all encased in a rigid channel of connective tissue underlying the dermis. When there is a need to retain body heat, arterial blood flows to the surface under low pressure and returns along the surrounding venous rete, which absorb heat from the central artery. To cool, blood flows under high pressure, thereby collapsing the surrounding veins against the rigid tunnel walls, and returns instead by superficial veins that lie closer to the surface of the skin<sup>33,117</sup>. The vessels in the flukes are the usual sites for blood sampling (Fig. 10.3).

The **gastrointestinal tract** has some unusual modifications<sup>41,50,52</sup>. The **esophagus** is penetrated dorso-ventrally by the laryngeal tube. In most species, food must pass to either side of this structure to reach the **three-chambered stomach**; in pygmy sperm whales, the left side is a blind pouch and food must pass to the right of the laryngeal tube<sup>144</sup>. Digestion begins in the first stomach (forestomach), actually an enlargement of the distal part of the esophagus, aided by enzymes and hydrochloric acid that reflux from the second (fundic) chamber. Undiluted acid in excess can produce ulcers in all chambers (particularly the first), a condition often seen in starving strandlings. The third (pyloric) stomach secretes mucus and prepares the food for intestinal digestion. In odontocetes, the first and second chambers often contain **nematodes**, and it is not unusual for the second and third chambers to have a mucosal surface embedded with grape-like structures, each containing the **trematode** *Braunina cordiformis*<sup>118</sup>. The intestinal tract of odontocetes is not visibly organized into small and large intestines<sup>126</sup>, and in small animals it can measure 20 to 30 m in length. Mysticetes have

a distinguishable colon<sup>135</sup>.

**Other notable features**<sup>41</sup> include the absence of a gall bladder, a peculiarly small and firm spleen, which may be accompanied by one or more even smaller accessory spleens, and a long chain of large mesenteric lymph nodes. The kidneys are elongated and lobulated, and the urinary bladder small. The testes are intra-abdominal and lie ventral to the kidneys. The testes in *Phocoena* and certain other species become so enlarged during the mating season that they exceed the kidneys in size and weight. Veins carrying cool blood from the dorsal fin and flukes are juxtaposed to arteries supplying the testes; the resulting



**Fig. 6.1.** External morphology of toothed (odontocete) and baleen (mysticete) whales. The genders can be distinguished by the difference in the configuration of the genital fold; the male usually has two openings, one behind the other, separated by a bridge of tissue. The female has a longer, more prominent slit which encompasses the closer-spaced genital and anal openings and is flanked by a small slit on each side containing the nipples. An object inserted into the genital opening of a female will be directed toward the head, and in a male, toward the flukes. **NOTE:** In males of *Phocoena* and *Kogia*, the genital aperture is situated much closer to the umbilicus than to the anus.

cooling action allows the production and storage of viable sperm under otherwise unsuitably high body temperatures<sup>110</sup>.

### **Natural History**

**Life histories vary widely among species** and even among geographic stocks. Some factors, including age at sexual maturity, lactation period and calving interval, are also influenced by external conditions such as population density and food availability, and are therefore subject to change<sup>34,70,93</sup>.

The smaller **odontocetes** have shorter life spans and accelerated reproductive cycles compared with the larger species. The little harbor porpoise, with a life span of only 7 to 15 years, becomes sexually mature at age 4 to 6 and has a gestation period of 10 to 12 months, followed by 6 to 8 months of nursing<sup>40</sup>. Sperm, killer and pilot whales, at the other end of the range, possibly live to 60 years or more; they reach sexual maturity at 8 to 10 years. The pregnancy lasts 14 to 16 months, and calves may nurse for 2 years or more<sup>10,60,93</sup>; the females of such species may have a long post-reproductive life<sup>60</sup>.

**Baleen whales** evolved reproductive cycles that are synchronized with annual migrations between low latitude winter calving grounds and high latitude summer feeding areas. Quite in contrast with the large odontocetes, these massive animals mature relatively young (4 to 10 years), carry the fetus for only about 10 to 12 months, nurse for a brief 4 to 10 months<sup>70</sup>, and reach ages of 50 to 80 years or more<sup>154</sup>.

The **social structure** of odontocetes is diverse. Some species, such as harbor porpoises, are usually seen singly or in pairs. Others, spinner dolphins for example, form highly organized schools that provide for them the benefits of cooperative foraging, protection from predators, and a safe neighborhood for rearing their young<sup>83</sup>. **Not all highly social species mass strand, but mass strandings always involve social species**, such as pilot, sperm and false killer whales (see Chapter 7). Baleen whales have a different social organization and, except for mother-calf pairs, appear to lack the binding dependence evident in odontocete schools. They occur alone or in loose aggregations, with behaviorally interacting units consisting of about 2 to 6 animals<sup>70</sup>. Circumstances (e.g. ice entrapment) have forced small groups of mysticetes to founder ashore, but in the true sense, these animals do not mass strand.

Although most odontocete species feed primarily on schooling fish and squid, many also include shrimp, crabs, and bottom-dwelling fish and invertebrates in their **diets**<sup>146,147</sup>. Animals of the same species may

have definite food preferences. For example, some pods of killer whales feed exclusively on fish, while others prefer marine mammals<sup>72,89</sup>. Mysticetes are adapted to foraging on prey that can be engulfed and strained from the water — dense patches of krill (euphausiid and copepod crustaceans) and small schooling fishes such as capelin and menhaden<sup>97</sup>. Gray whales, unique among mysticetes in feeding behavior, scour the bottom in search of benthic invertebrates<sup>81</sup>.

### Distribution

**More than 40 species of cetaceans occur in North American waters**<sup>66,67</sup>, but only some of these are found predictably in specific areas. Fin and sperm whales and Risso's dolphin, among others, are wide-ranging and have far different stranding patterns than animals with a more restricted distribution, such as the vaquita of the northern Gulf of California. Some are **coastal** year-round (e.g., gray whales, harbor porpoises, some bottlenose dolphins), while others come inshore periodically (e.g., long-finned pilot whales), during calving or migration (e.g. beluga whales, right whales) or even diurnally (e.g., Hawaiian spinner dolphins). **Pelagic** species such as beaked whales may be seen at sea so rarely that their description relies entirely on stranding records.

**Topographic and oceanographic conditions influence the coastal cetacean fauna**<sup>152</sup>. The inshore waters of the warm, shallow Gulf of Mexico are virtually uninhabited by baleen whales at any time of the year. Northern right, fin and humpback whales do occur, however, in cool, deep waters offshore in winter<sup>35,115,116</sup>.

On the Atlantic coast, the Gulf Stream occasionally brings warm temperate species such as the bottlenose dolphin and dwarf sperm whale as far north as the Canadian Maritimes, while the broad shelf keeps pelagic species further offshore. Inshore waters north of Cape Hatteras are influenced by the Labrador Current and are home to cold water species such as the harbor porpoise and Atlantic white-sided dolphin<sup>35,66,115,123,124,149</sup>.

The steep, rocky Pacific coast allows pelagic species, such as the short-finned pilot whale, close to shore, while the California Current brings such cold water forms as the harbor porpoise as far south as southern California. Warm temperate species (e.g., bottlenose dolphin) seldom occur north of central California<sup>67,84,95,152</sup>.

Northern waters are a permanent home for some species, while others only visit there during the summer months. The bowhead whale, narwhal, and beluga are more or less confined to Arctic and subarctic waters, the beluga being the most wide-ranging of the group<sup>54,102</sup>.



Wanderers from the isolated St. Lawrence River stock occasionally reach Nova Scotia and New England and have been reported as far south as Long Island Sound<sup>88,100</sup>. During the summer, blue, fin, minke, sei, right, gray and humpback whales move into northern feeding grounds.

The Hawaiian Islands are an archipelago of steep-sloped volcanic cones, offering little in the way of a coastal shelf able to support large numbers of resident cetaceans. A wide variety of pelagic forms occurs in nearby waters, as evidenced by known stranding records involving about 20 species<sup>82</sup>. Some of these, including short-finned pilot whales, pygmy killer whales, rough-toothed dolphins, and pantropical spotted dolphins are common year-round in the deep channels between the islands. Nearshore species include a wintering population of humpback whales, resident communities of bottlenose dolphins, and the pelagic Hawaiian spinner dolphin that moves into coastal waters during the day<sup>5</sup>.

The size of a cetacean population is not easily determined, particularly for pelagic stocks. Populations of baleen whales in North American waters are estimated to range from hundreds (e.g., blue whale, northern right whale), to thousands (e.g., humpback, bowhead whale), to tens of thousands (gray whale, fin whale)<sup>152</sup>. A species abundant in one area may be in peril in another (e.g., Western Arctic vs. St. Lawrence River beluga stocks)<sup>96,127</sup>, depending on regional conditions such as habitat degradation, patterns of exploitation, and fisheries interactions that might influence food abundance, health and survival.

## 6.2. Mortality

### Natural Mortality

Little is known about natural mortality in cetaceans, because it is difficult to garner such basic information as population size, calf production and survival data, and accurate age estimates<sup>87,93</sup>. The type of long-term observations made on killer whales in British Columbia waters<sup>10</sup> or Florida bottlenose dolphins<sup>120</sup> are not feasible for most species. Instead, information comes from stranded animals<sup>21,23,47</sup>, those harvested commercially<sup>19,20,130</sup>, and some taken incidentally in fisheries operations<sup>22,92,143</sup>.

Following the general mammalian pattern, **mortality is high in the very young, decreases sharply with maturity, and increases again in advanced age**<sup>98</sup>. Species that provide longer maternal care have greater juvenile survival<sup>87</sup>. Mortality rates seem higher in males than

females in species presumed to be polygynous (i.e., dominant males mate with a number of females), including pilot and spermwhales<sup>98</sup>.

Some mortality is related to **environmental conditions**. Cetaceans in high latitudes occasionally become trapped in ice, and may subsequently die of starvation or fall victim to predators or hunters. As many as 3,000 beluga whales at one time<sup>15</sup> have met this fate, as have narwhals, gray whales, bowheads, and white-beaked dolphins<sup>125,128</sup>.

Nearly every cetacean beyond the age of a newborn has **parasites** (Fig. 10.28-10.29); some may even be acquired *in utero*<sup>26</sup>. Some parasites play an arguable role in disease and mortality<sup>48</sup>. Nematodes that reside seemingly innocuously in lungs and stomach can overwhelm a host facing other stressful conditions. Aberrant migrations of trematodes through the brain have been linked to strandings of common dolphins<sup>106</sup>. Damage to the bones of the head, caused by nematodes of the genus *Crassicauda*, has been linked to mortality of young pantropical spotted dolphins<sup>92</sup>. Other species of *Crassicauda* injure renal blood vessels<sup>65</sup> and mammary tissue, perhaps with serious effects<sup>45</sup>. Small respiratory tract nematodes of the genus *Stenurus* are commonly found in the auditory or eustachian tubes, middle ears and cranial sinuses, but there is no firm evidence for the popular notion that they precipitate strandings.

Cetaceans have been found with cardiovascular problems, lung **diseases** not associated with parasites, nutritional disorders, and infections caused by a range of opportunistic pathogens<sup>12,23,104</sup>. These conditions simply reflect the broad range of illnesses facing any species, and none is regarded as having population-wide effects.

However, certain **large-scale threats** are becoming identified. The recent outbreak of morbillivirus infection that killed at least 750 striped dolphins, *Stenella coeruleoalba*, in the Mediterranean<sup>28,30,141</sup> suggests that **viruses may have long been overlooked as possible causes of mass mortality**. Fourteen humpback whales died near Cape Cod after eating fish that contained **saxitoxin** produced by the marine dinoflagellate *Gonyaulax tamarensis* (responsible for paralytic shellfish poisoning in humans)<sup>44</sup>. **Brevetoxin** produced by *Gymnodinium breve* was implicated in the mass mortality of bottlenose dolphins along the Atlantic coast during 1987-1988<sup>42</sup>. If these events are linked to human-induced changes in the environment, they may foreshadow an emerging trend in cetacean mortality.

### Human-Related Mortality

Cetaceans too often become trapped in fishing nets. **Entanglement associated with coastal fisheries** is a serious threat to the harbor porpoise throughout much of its range<sup>27,99,140</sup> and has driven the vaquita to critically low numbers<sup>140</sup>. It is also a significant cause of injury and death to humpback whales, mainly around Newfoundland<sup>139</sup>. Occasional entanglements combined with ship collisions may be impeding the recovery of the northern right whale<sup>63,108</sup>.

**Pelagic fisheries**, particularly in the North Pacific, are harmful<sup>140</sup> to offshore species. Large numbers of spotted and spinner dolphins, and Pacific white-sided and northern right whale dolphins, among others, are taken in purse seines and drift-nets. The situation in the Eastern Tropical Pacific has steadily improved over the past two decades with the introduction of new fishing techniques for tuna. Restriction of North Pacific high seas drift-net fisheries since 1987, combined with the planned global moratorium beginning in 1993, will further reduce the needless killing of pelagic marine mammals.

**Oil spills**, like other forms of pollution, contribute to overall degradation of habitat, can influence prey abundance and diversity, and may increase stress and susceptibility to infection<sup>43</sup>. Some cetacean populations have accumulated high levels of **contaminants** that are tentatively linked with disease, including tumors and reproductive disorders<sup>1,39,46,73</sup>.

Rarely, a cetacean is the victim of a **bullet wound**<sup>131</sup>. In stranded animals, the opening left by an entering bullet may be too small to detect without careful dissection, or difficult to distinguish from damage inflicted by scavenging birds and embedded sea shell fragments<sup>51</sup>.

### 6.3. Stranding Patterns

Coastal animals that reside in an area or migrate through it seasonally have a stranding pattern that is predictable and more or less consistent<sup>75</sup>. Bottlenose dolphins strand throughout the year in the southeastern United States, whereas newborn gray whales are likely to come ashore in the lagoons of Baja California only during the winter calving season. These trends have a long history that is rooted firmly in the biology of the species. More recently, traditional patterns have become complicated by human activities that are less direct and not always predictable — for example, a coastal fisheries operation that, when in full swing, may have a serious impact on local cetaceans.

**Stranding patterns are not quite as evident for pelagic species,**

although correlations with locations, tides, storms, geomagnetic disturbances and other factors have been proposed (see 7.1). Some species follow the inshore migration of prey. Long-finned pilot whales, for example, pursue squid into shallow waters of Cape Cod Bay during the autumn and early winter and can be expected to strand during these seasons. These events also correlate somewhat with storms that combine with monthly peak tides.

Animals that strand in a cluster over a period of a few days may be victims of poisoning<sup>42,44</sup>, infectious disease<sup>28,30</sup>, intensive local fisheries operations<sup>14,27</sup>, or unusual environmental events<sup>75</sup>. These episodes can be of such short duration that the ultimate cause may no longer be evident by the time the investigating team takes action.

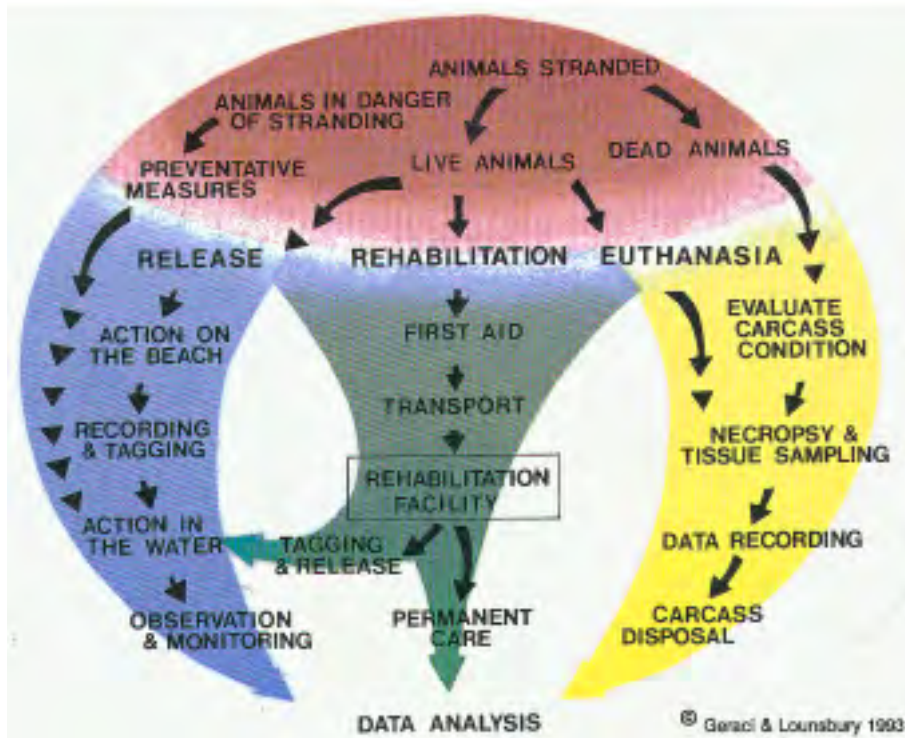
The mother/calf bond is strong and may remain so long after the end of lactation<sup>17</sup>. Consequently, if both come ashore, it may be impossible to determine which led the way. Young males of some social species may appear alone at predictable times of the year. For example, juvenile white-sided dolphins strand along the northeast coast during the fall, suggesting they may have been lost or displaced from a bachelor group. There is evidence that yearling *Tursiops* come ashore alone after being displaced from the herd during the breeding season<sup>144</sup>.

Animals that wander **beyond their normal range**, fail to migrate with the onset of winter, or make unusual appearances in bays or far up river, always generate public interest. A single male beluga whale, apparently a stray from the St. Lawrence River population, resided in Long Island Sound for over a year before it died from a gunshotwound<sup>88</sup>. "Humphrey," a humpback whale reluctant to leave San Francisco Bay in October 1990, was finally towed out to sea after elaborate efforts failed to coax him to leave on his own. When bottlenose dolphins left their summer feeding grounds off northern Virginia in the fall of 1988 and headed south for warmer waters, "Rascal," a young male, stayed behind. Lingered in a shallow near-frozen bay, he extracted sympathy from every conceivable source, until he was "rescued," placed into a facility, and released months later. Rescue efforts following the ice entrapment of three gray whales in Alaska in 1988 became an international event<sup>114</sup>. **Public sentiment may override any consideration as to whether intervention in these cases is necessary, justifiable or even possible.**

## 6.4. Stranding Response

### Jurisdiction

All cetaceans in U.S. waters fall under the jurisdiction of the National



**Fig. 6.2.** Options for responding to stranded cetaceans.

Marine Fisheries Service and are protected by the Marine Mammal Protection Act of 1972. The sperm whale and the vaquita, as well as all baleen whales except minke and Bryde's whales, are also listed under the Endangered Species Act.

### Evaluating the Event

A cetacean may be observed swimming dangerously close to shore, although for some, such as right whales, this is normal behavior. If there is no obvious injury or disability and intervention is deemed necessary, attempts can be made to direct the animal back to sea. This has been done by using boats and chains of people (under calm conditions) as a means of herding, and by creating disturbance and underwater noise (slapping the water's surface or striking objects together below it, using boat engines)<sup>109,145</sup> (Fig 6.3). Under the best of conditions, it is difficult to sustain the effort needed to herd an animal a long distance, and there is a good chance it will come ashore somewhere else, probably close to the original site. **If the animal is seriously debilitated, no amount of effort is likely to avert the eventual stranding.**

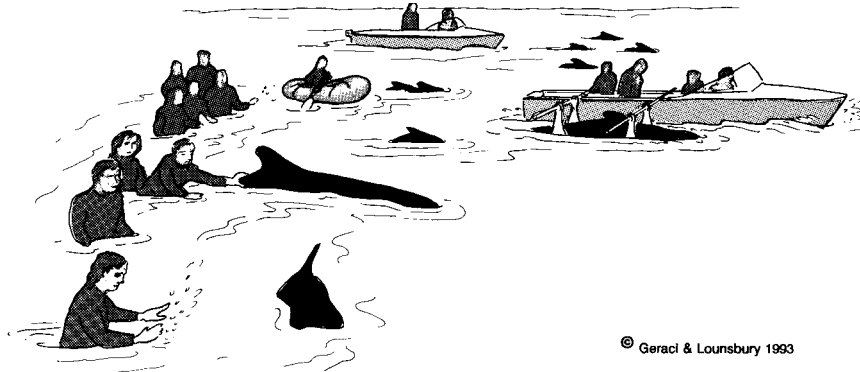
The response team's appropriate course of action for a stranded

cetacean will depend on the animal's size, age and health, the available support, environmental conditions, and the time on the beach (see 4.3). The **options** are to tag and release the animal if it is healthy, transport it to a facility for medical attention, euthanize it, or let it die naturally. Decisions should be timely and the action swift to relieve the animal of progressive injury and discomfort.

Except for obvious abnormalities, **it is not always possible to judge the health of a cetacean by its outward appearance**. Even sophisticated tests may not reveal the nature of the illness, and such analyses take more time than the beached victim can spare. When circumstances do not permit an exhaustive examination, certain broad assumptions can be made to anticipate the animal's health. These assumptions are based on an understanding of life history and historical stranding patterns.

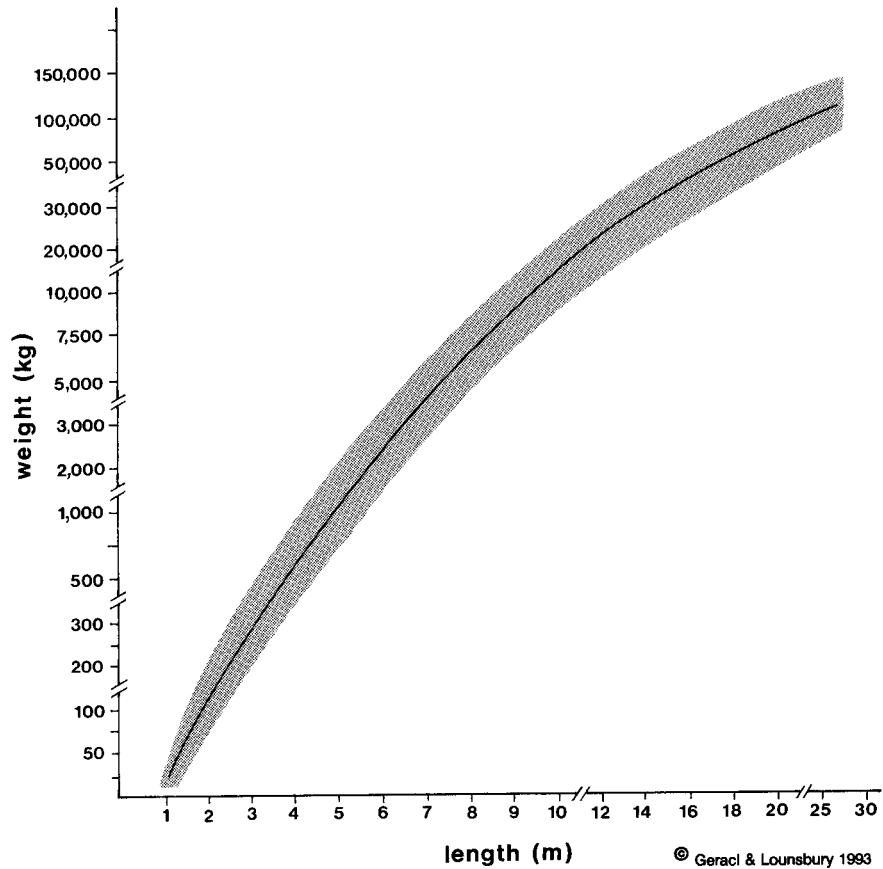
**Coastal animals such as *Tursiops*, expected to be familiar with the nearshore environment, usually strand singly only when ill<sup>23,47</sup>**, although they may be occasional victims of an outgoing tide. Unless it's a simple case of refloating, their only reasonable chance of survival is in a care facility. Some offshore animals have characteristic illnesses. *Delphinus* off the California coast frequently strand because of terminal brain damage caused by the trematode *Nasitrema*<sup>106</sup>; even with the best medical care, there is little chance they will recover.

**Many pelagic specimens come ashore in apparent good health**, or at least free of recognizable disease. Smaller ones on the beach for only a short period of time have a reasonable chance of withstanding the rigors of being returned to sea<sup>4,109,112,113,145</sup>, although their **long-term survival is undocumented**. The larger the animal and the longer it lies



© Geraci & Lounsbury 1993

**Fig. 6.3.** Techniques for stranding prevention and returning cetaceans to sea, including use of underwater noise, manual re-orientation, herding with small craft, and towing in a sling or stretcher.



**Fig. 6.4.** This graph can be used to estimate the weight of a cetacean of any given length. Derived from literature sources used to prepare section 6.13, it is based on average to maximum size and represents species occurring in North American waters. **NOTE: This information is not to be used as a guide for administering medications or anesthetics**, as many stranded animals are emaciated and fall far below this average range, while others, such as heavy-bodied species or pregnant females, may be above it.

on the beach, the less likely it is to survive after release. Nothing can be done to save a whale too large to handle with the available resources, or one that has suffered prolonged exposure. The animal should either be euthanized or left to die naturally; the latter is becoming more unacceptable to the general public.

#### **Specific Equipment** (see also 2.5)

Much of the equipment required for cetacean strandings is geared to moving or supporting the animals. Any specimen beyond the size of a small pilot whale will require heavy equipment. (Refer to Fig. 6.4 for help in estimating an animal's weight). Many devices specifically designed

for moving cetaceans have been cumbersome and impractical to use. Basic equipment will generally prove to be the most useful. These items include:

foam pads or mattresses	tarpaulins
sheets, towels or blankets	zinc oxide
shovels	ropes
buckets	slings
water sprayers	stretchers and poles
“space blankets”	inflatable rafts
heavy machinery (cranes, front-end loaders)	

## 6.5. Approach

Observe the animal’s behavior and prepare a safe plan before making the approach. Advance slowly, calmly and cautiously, avoiding loud or startling sounds, abrupt movements, or bright lights. This will allow the stranding to become gradually accustomed to your presence. The animal is not likely to be aggressive, but people have been bitten accidentally, and the thrashing flukes of a confused whale have wrecked more than one knee joint. **Only persons with experience should approach the animal, keeping well clear of the flukes and mouth.**

**Animals may panic** in certain situations. A mother separated from her calf or attempting to protect it may become aggressive<sup>17</sup>. A lone member of a social species may become frightened when separated from the pod<sup>83</sup>. Consider the animal’s possible response to your intended actions.

## 6.6. First Aid

### Determining Condition

Countless procedures are used to evaluate the health of an animal, ranging from distant observation to blood and tissue analyses<sup>85,104,133,134</sup>.

Behavioral observations are quick, non-invasive, and can be done by persons with minimum training. **Behavioral criteria** can be used to assign animals to one of three categories<sup>31</sup>:

1. **alert** (aware, responsive to environmental stimuli)
2. **weakly responsive** (responsive only after much stimulation)
3. **non-responsive** (not responding to noise or touch)

A stranded cetacean inevitably develops **respiratory fatigue and distress**. This occurs sooner in larger animals whose chest cavity will be



more severely compressed by body weight. Signs include irregular and increased respiratory rate (up to 6 to 8 breaths/minute may be normal for an excited *Tursiops*; a fin or pilot whale may respire as little as once every minute or so) and audible gurgling sounds as the animal breathes in and out. If respirations are slower than expected, flushing water over the blowhole may stimulate breathing<sup>144</sup>. Extensive bleeding, frothy or foul-smelling fluid from the blowhole are signs of critically poor health.

Without using invasive procedures, it is possible to make a rough evaluation of **cardiovascular function**. Heart rate, for what it is worth, can be determined using a stethoscope in a small animal, and perhaps by placing a hand firmly under the axillary region of a larger one. Even under normal conditions, however, the rate varies considerably (e.g., from 30 to 100 beats/minute in *Tursiops*<sup>104</sup>) during the breathing cycle. One result of deteriorating cardiovascular function is poor circulation, making it difficult to obtain blood samples from the usual peripheral sites (see 10.2). Body temperature control is also reduced when blood fails to reach the extremities where excess heat is normally dumped.

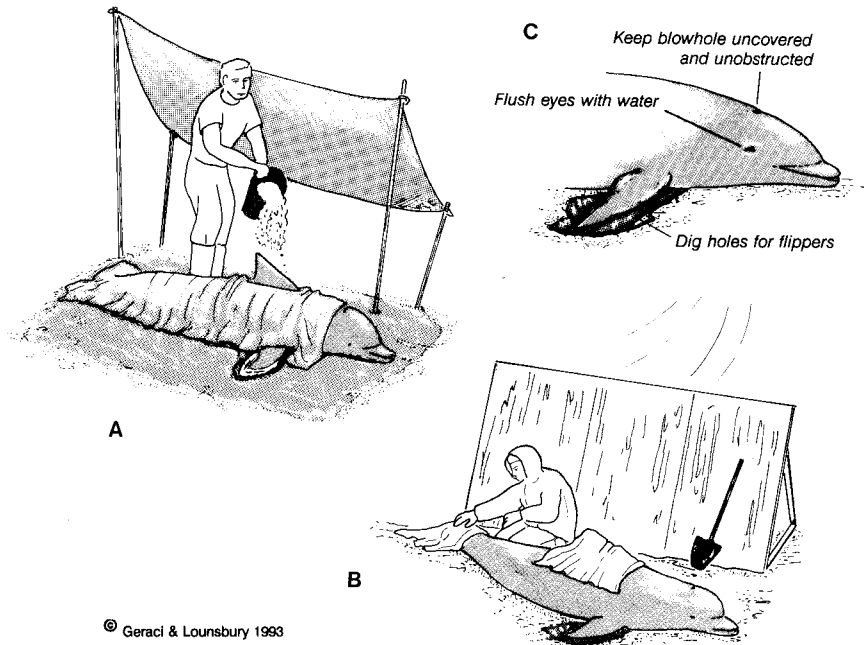
**The next level of assessment requires handling the animal**  
Gentle tapping near the eye should elicit a blink. Attempts to pry open the jaw, pull the tongue or tug the flipper forward should be met with firm resistance. Once the jaw is open, a finger pressed firmly on the gums over the teeth causes blanching followed by immediate return of normal pink color; a slow return or bluish discoloration is a sign of poor circulation.

**Body temperature** can be determined accurately enough for early assessment purposes using a deep rectal thermometer. In small to medium-sized animals, normal temperatures are about 36.5° to 37°C. In cold weather, temperature may drop rapidly below 35.6°C, signalling the onset of **hypothermia** or **cardiovascular shock**. Temperatures above 40° C are critical and above 42° C probably terminal<sup>112</sup>.

If time permits and a clinical laboratory is accessible, a **blood sample** may be collected for hematologic and plasma chemical analyses. These may reveal conditions that are not readily apparent and can help establish a long-term prognosis.

### **Supportive Care**

**General** — The time between stranding and the arrival of the rescue team can be gainfully used by volunteers to relieve distress and improve the animal's chance of recovery (Fig. 6.5). The key is to **prevent further injury and keep the animal comfortable while minimizing handling and disturbance**.



© Geraci & Lounsbury 1993

**Fig. 6.5.** First aid measures on the beach. **A. Summer:** provide shade, drape leaving dorsal fin exposed, and keep moist; dig holes for flippers and fill with water. **B. Winter:** provide protection from wind, cover dorsal fin and flukes with cloths soaked in vegetable or mineral oil; dig holes for flippers. **C. Always:** keep blowhole unobstructed and eyes free of sand; allow flippers to assume a natural position.

The eyes and blowhole must be protected from blowing sand and kept moist with clean fresh or salt water. Flushing the area around the blowhole can be done only when the blowhole is closed; the best time is immediately after the animal breathes. Inexperienced persons should observe the breathing sequence before attempting to do this. No matter where water is applied to clean or cool the animal, the source (hose, bucket, sponge) should be held close to the skin to minimize the startle reflex.

It is easier to keep the blowhole free of water and sand, and presents less risk to the lungs, when the strandling is placed on its belly. This can be done easily with a small animal, but in larger ones, only with some risk to the rescuers. Using a spade to burrow beneath the animal, dig holes in the sand to allow the flippers and flukes to lie in a natural position. Banking sand or placing other (non-injurious) material alongside the body will reduce the tendency to roll.

**Exposure to Warm Temperatures** — For their comfort and well-being, animals on the beach must be protected from the elements (Fig.

6.5). Prolonged exposure to wind and sun can result in excessive drying and damage to the skin, overheating at warm temperatures(**hyperthermia**), and **hypothermia** at cold temperatures.

A cetacean on the beach faces the risk of **hyperthermia**, even on cloudy temperate days. The risk increases dramatically as the temperature rises. Dark skin absorbs heat, blubber retains it, and the circulatory system that normally helps to dissipate heat may be sluggish and not up to the task. A whale out of water has no other mechanism to cool itself.

The danger of hyperthermia can be minimized by draping exposed surfaces except the blowhole with towels or sheets kept moist by periodic wetting. Lighter colored materials are preferable because they reflect light and heat, but in a pinch, items of clothing, newspapers, or even wet seaweed or mud will do. If the situation permits, a small shelter constructed over the animal will provide valuable protection. Heat loss occurs principally from the extremities, which should therefore be kept wet or cooled with ice. A trench dug in the sand around the animal can be kept filled with water through a channel connection to the sea.



An application of zinc oxide will protect skin from sun and windburn and help prevent dehydration. Oil-based compounds (lanolin), including those used in sun tanning products, retard heat loss and may do more harm than good. Skin already damaged should be kept moist, shaded and protected with zinc oxide or antibiotic ointment.

**Exposure to Cold Temperatures** — A good layer of blubber insulates an animal against cold. Emaciated specimens, calves and small species are at greater risk of becoming **hypothermic**. The diagnosis requires some expertise. On a frigid beach, provide shelter from wind and precipitation, and cover the extremities with a mineral or vegetable oil-dampened cloth.

**Protection from Surf** — A cetacean in the surf zone may be battered by waves, trapped among rocks, rolled onto its side or become mired. If the animal is too large to be moved into deeper water or to higher ground, shift it so it is perpendicular to the water's edge, with the head facing land. In this position, the body offers the least resistance to the surf, and the blowhole is as far from water as it can be under the circumstances.

Heavy, struggling animals can become bogged down and trapped in sand or mud that eventually fixes them into place. They are then victims of the rising tide and nearly impossible to rescue because of the difficulties and hazards of working in soft sediments.

**Lacerations and Injuries** — Sharp rocks and sea shell fragments can have the same effect on cetacean skin as a keen-edged knife, causing serious injury to a struggling animal. The risk of lacerations can be reduced by removing or covering hazardous objects, placing padding around the body, or moving the victim to a safer place. Efforts to calm or restrain whales under these circumstances are unrealistic. **Tranquilizers and sedatives should never be used on animals that are to be immediately released.**

There is no proven benefit to medicating an animal that has just stranded and is about to be released. Without opportunity for continued care, a single application of ointment, a bolus of antibiotics, or a feeding of fish has little value. However, an animal that faces a longer period out of water before it is released or transported will benefit from prompt medical care to wounds, fluid therapy to maintain hydration, and even a long-acting antibiotic.

**Stress and Shock** — A cetacean on the beach is almost certainly stressed. Stimulated by the pituitary gland, hormones (cortisol and aldosterone) from the adrenal cortex are released into the circulation<sup>137</sup>. The presumed benefit of cortisol is to ensure a supply of blood

glucose and reduce some of the adverse consequences of the inflammatory response. Aldosterone is also released, probably to maintain salt and water balance under critical conditions. Sustained high cortisol has deleterious effects on circulating white blood cells, wound healing and the immune response; prolonged high aldosterone causes excessive sodium retention, thereby increasing the animal's thirst for water.

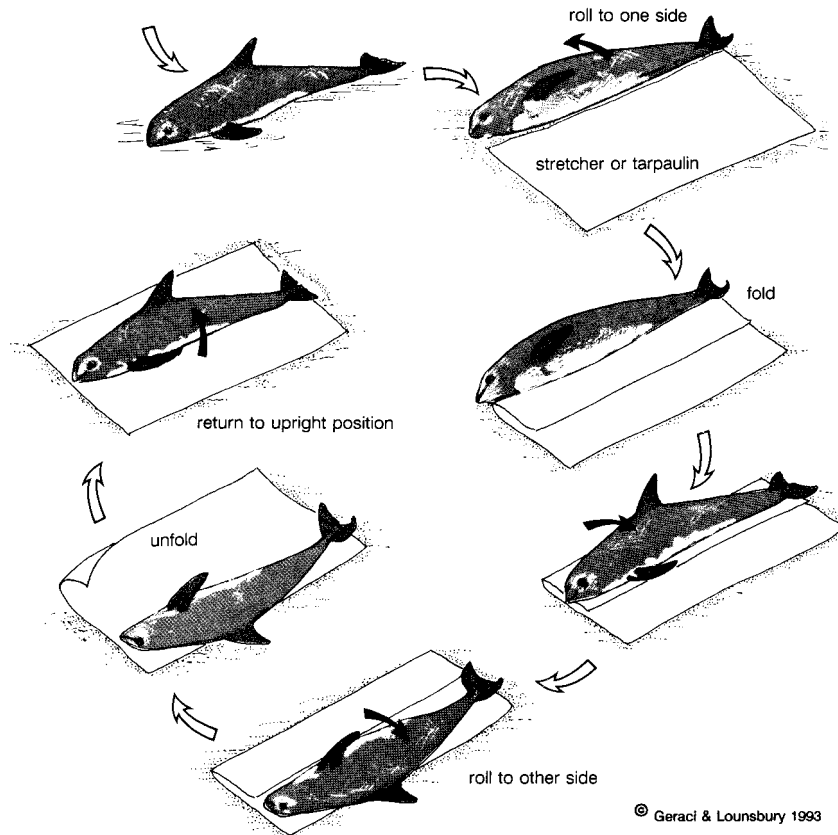
**Within a few hours after stranding, some cetaceans begin to show evidence of shock or vascular collapse<sup>49</sup>.** Blood pools in the thoracic and abdominal viscera, with effective circulation only to the heart and brain. The rest of the body is largely bypassed, and organs such as liver, muscle and skin, lacking blood, begin to exhibit impaired function. Compounds normally metabolized and detoxified by the liver can accumulate to dangerous levels, cortisol and aldosterone among them. Since the animal may appear to be healthy, **blood studies are required to detect these changes.** Only a long course of intensive care offers some hope of recovery. **Whatever the reason the whale came ashore, the onset of shock further impairs its chance of survival.**

Rescuers have attempted to reduce circulatory problems and muscle cramps by periodically shifting the animal's body position and rolling it onto each side for 20 minutes or so<sup>29,109,145</sup>. If a stretcher is available, floating the animal in shallow water may be of some value. Some advocate massaging the muscles of the back<sup>109</sup>; this procedure may benefit a small animal, but it is not likely to be effective on a larger one with thick blubber. Corticosteroids and other medications may help minimize muscle damage and delay the onset of shock<sup>133,144</sup>.

## 6.7. Handling, Lifting and Moving

In any rescue operation, moving and handling are critical activities, whether dragging an animal from dangerous surf, maneuvering it into deeper water for release, or loading it onto a transport vehicle (Figs. 6.6, 6.7, 6.8, 6.10). **Most procedures are potentially injurious to both the animals and personnel** and should only be attempted when supervised by trained staff and when adequate support is available. Six people might be able to carry a medium-sized bottlenose dolphin on a stretcher, whereas a beluga or pilot whale may require 16 or more strong bodies.

Several methods are useful for moving small whales and dolphins. An animal can be placed or rolled onto a tarpaulin or stretcher (or plastic "snow sheet") (Fig. 6.6), then lifted or dragged (Fig. 6.7). Field stretchers should be large and strong enough to bear the weight of any reasonably large animal, which means a small one will be safely enveloped in it.



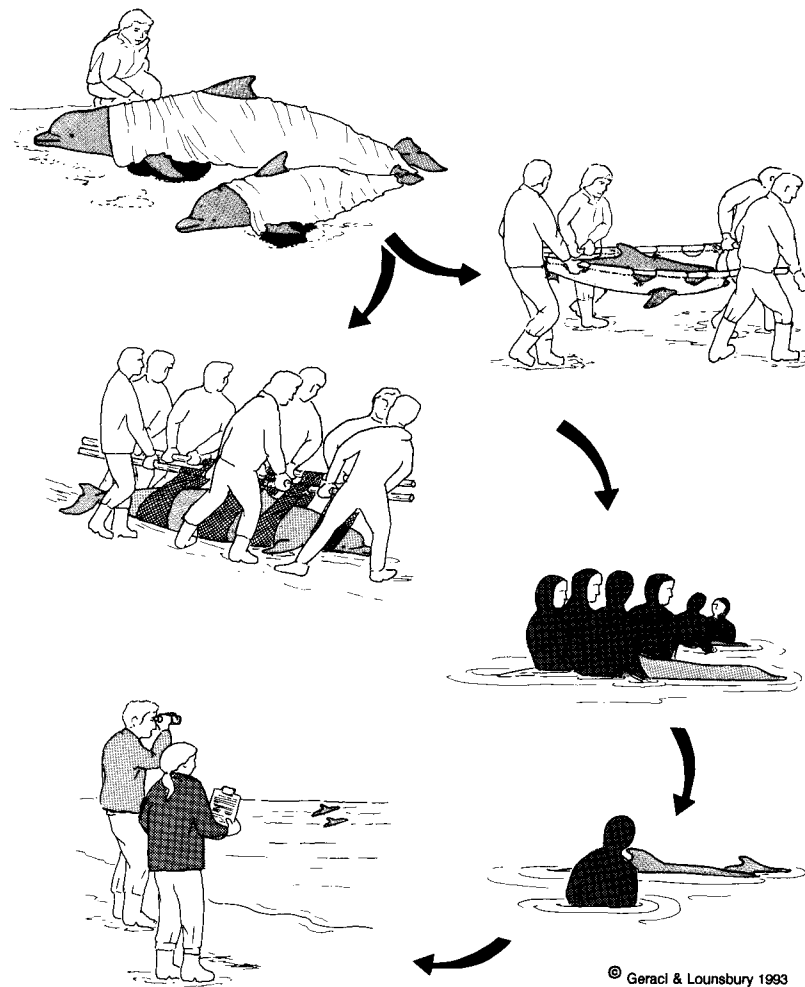
**Fig. 6.6.** Technique for positioning a cetacean onto a tarpaulin or stretcher without lifting.

When the whale will remain in the stretcher for more than 15 or 20 minutes, openings must be provided for the flippers (Fig. 6.8) (to prevent crushing and overheating) and the genital region (to prevent urine burns). For short rescue procedures, the flippers may be more conveniently kept within the stretcher. Fabrics should be smooth and easy to clean and sterilize; canvas, woven plastic, and netting are commonly used. Lining with towels or sheeting ("lambskin" liners are heavy when wet and trap sand) further reduces the chance of skin injury. Once the animal is in the stretcher, care should be taken to ensure no seams or creases press into the skin.

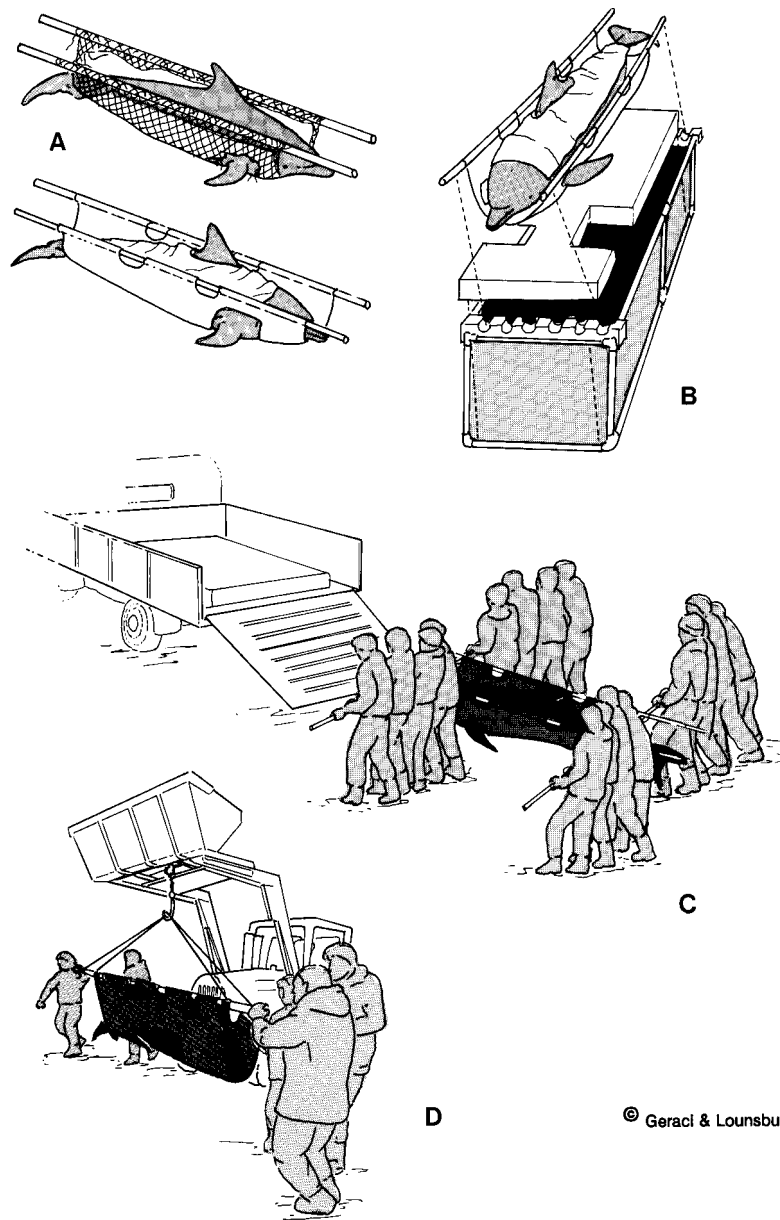
**Dragging is an acceptable option only when lifting is impossible.** Slings positioned under the body behind the flippers can be used to drag the animal on the beach or to support it in the water (Fig. 6.7, 6.10); on land, extra support under the head may be necessary. Ensure that such

slings are well-padded and wide enough to distribute pressure sufficiently to minimize injury and discomfort when the animal is pulled. **Never use naked rope as a sling.** Drag only over smooth terrain after all obstacles have been removed.

Although it has been suggested to be an effective means of moving cetaceans<sup>109,145</sup>, **rolling is not recommended**<sup>112</sup>. An animal healthy enough for release can be expected to react violently. This procedure will certainly be stressful and may result in damage to the flippers or dorsal



**Fig. 6.7.** General rescue sequence involving first aid and supportive measures; moving the animal to the water by lifting in a stretcher or dragging with slings; support in the water with gradual acclimatization; and observation and monitoring of released animals.



**Fig. 6.8.** Cetacean transport methods. **A.** Stretchers with holes for flippers. **B.** Specially constructed transport box with foam pad and waterproof liner. **C.** Manual method of moving a small pilot whale onto a foam-padded transport vehicle, using poles positioned cross-wise through stretcher handles to allow necessary support. **D.** Use of heavy equipment to move whales.

© Geraci & Lounsbury 1993



fin. If an animal is small enough to roll, it is small enough to maneuver onto a stretcher or sling.

Cranes and other heavy lifting equipment are needed for moving large specimens and for loading them onto transport vehicles (Fig. 6.8). Secure the animal in the stretcher with enough rope or straps to prevent thrashing, and attach guide ropes or “tag lines” that will enable handlers to hold the stretcher steady. Make sure that no one stands directly underneath the load.

## 6.8. Immediate Release

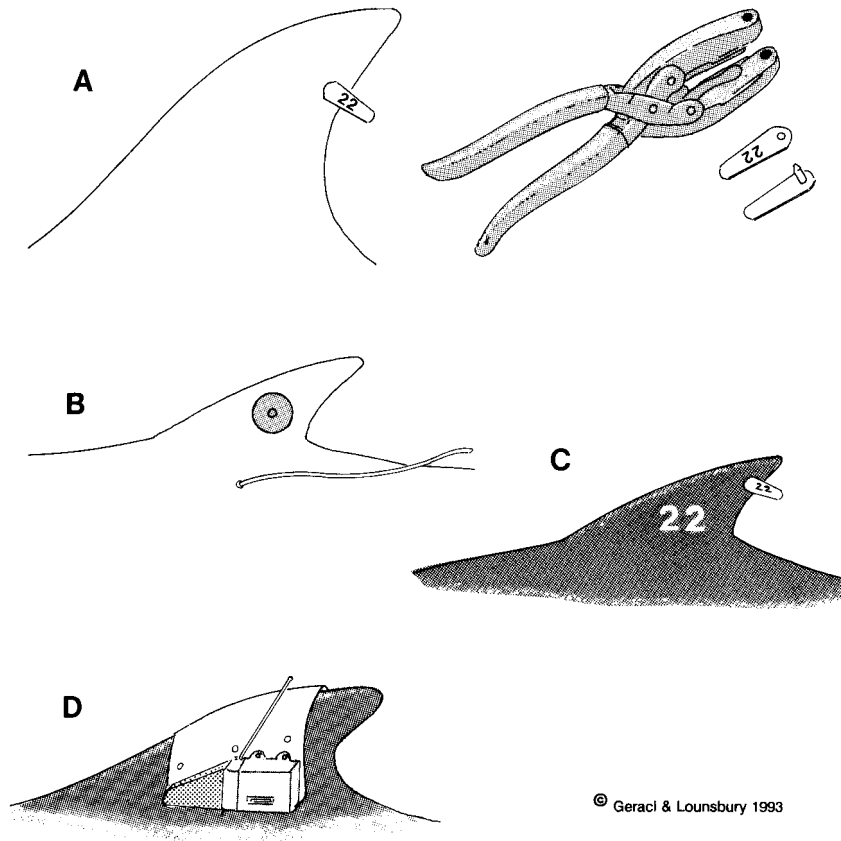
### General Considerations

Coordinate the animal’s release with an incoming or high tide, and assure that personnel and equipment are adequate for operating in the surf zone and perhaps deeper water. Choose a route that is free of obstacles such as shallow reefs or sandbanks, by first consulting a hydrographic chart or persons familiar with the area. Under some conditions, transport to an alternate site—perhaps miles away—may be necessary. When weather or tide conditions are unsuitable, the animal may be placed in a tidal pond or fabricated pen enclosure and released when circumstances improve.

Make every effort to keep a mother and calf together during release. A free-ranging dolphin may remain with her dead offspring for weeks<sup>17,84</sup>, suggesting that returning even a dead calf to the water with its mother may help to prevent her restranding. **Orphaned maternally-dependant young should not be released under any circumstances. Calves whose mothers cannot be verified should be considered orphaned.** Lone animals of a social species are not good candidates for release, unless there is a good chance they will regain contact with a herd (see 7.6).

### Marking and Tagging

**Any animal returned to sea should be marked or tagged<sup>57,59</sup>** (see Fig. 6.9) and the details of its release carefully documented. Only then can observers determine whether or not the animal survived and if rescue procedures were effective. Dorsal fin tags are easy to apply with the appropriate attachment devices. They can be made in various colors, shapes and sizes. Every team should be equipped with a quantity of colored or numbered plastic cattle ear-tags, and a small boring device for attaching the tag through the dorsal fin. Freeze brands are effective for long-term marking but are not immediately visible and must be



**Fig. 6.9.** Some techniques for tagging cetaceans. Skill and experience are required to minimize tissue damage and prevent infection. The dorsal fin or ridge is the preferred site for convenience of attachment and visibility. **A.** Large plastic cattle ear tags, attached with special pliers, can be used to mark carcasses and to tag live animals prior to release. Tags are attached through the trailing edge of the dorsal fin and cause little tissue damage when they are lost. These tags may be retained for several months, but are reliable only for short-term observation. **B.** Other types of markers include a "button" tag, a plastic disk attached by a bolt through the dorsal fin, and a "spaghetti" tag, a streamer with a barbed head anchored in the blubber<sup>57,67</sup>. **C.** Freeze-brands on the dorsal fin or on the sides just below it can provide long-lasting marks that are visible from a distance. Brands will not be clear immediately and are best combined with a plastic dorsal fin tag for interim observation. **D.** Satellite or VHF tags can be mounted on a molded plastic "saddle" that is bolted through the dorsal fin. (Additional reference: Mate, B. 1988. *Development of satellite-linked methods of large cetacean tagging and tracking in OCS lease areas - final report. OCS Study 87-0038. U.S. Department of Interior, Minerals Management Service, Alaska OCS Region, Anchorage, AK. 137 p.*)

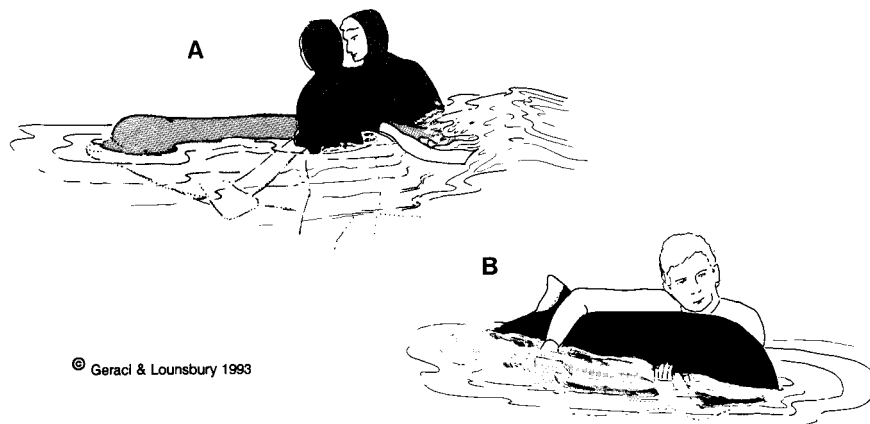
combined with some other type of tag. Radio (satellite or Very-High-Frequency [VHF]) tags provide much more information but are costly and require specialized tracking equipment. **Tags can be applied only by trained personnel. Natural marks (e.g., unusual fin or fluke shapes, scars) should be photographed** to assist in later identification of re stranded animals, or as a way to monitor individuals from small, local populations.

### Acclimating Animals in the Surf

There is more to releasing a stranded whale than hauling it back to sea. Without careful planning, handling and treatment, rescue attempts can end in disaster.

In preparation for its release, the animal on the beach should be kept wet and cool to avoid a quick change in temperature that might evoke a startle reaction<sup>85</sup>. Once in water, the body should be kept upright and the blowhole clear of the surface. One person alone may be able to handle a harbor porpoise (assuming reserve help is on hand), but certainly more are needed for a larger species (Fig. 6.7, 6.10). Acclimation is not complete until the animal is able to surface on its own to breathe. The process can take a long time and puts rescuers at risk of hypothermia. Proper gear (e.g., wet suits) and a relief team must be available (see 12.2, 12.3). A mother and calf should be acclimated together.

Gentle side-to-side rocking of an animal that is not fully coordinated when refloated, has the presumed benefit of restoring blood circulation and muscle tone<sup>4,113,145</sup>. Some species, such as false killer whales,



**Fig. 6.10.** Supporting cetaceans in the water. **A.** Use of strap or sling to keep blowhole above surface. **B.** Supporting a small porpoise.

tolerate this handling well, while others, such as striped dolphins, react violently. Abandon the procedure or use a more gentle approach if the animal resists<sup>36</sup>. After about 30 minutes of rocking, try again to move the animal into deeper water.

Many cetaceans restrand with frustrating persistence, each time compounding the damaging effects of the last stranding, until their condition is irreversible. **The rescue team should know when to quit and pursue another alternative.**

### **Herding and Towing**

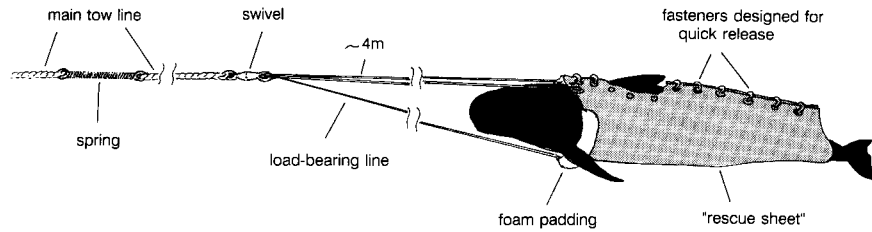
The animal, even when acclimated, may need to be directed outward to sea. Doing this by swimming alongside is risky because a cetacean's behavior is unpredictable. Kayaks and surfboards are light, portable, and work well in shallow water<sup>36</sup>. "Jet" boats are quiet, maneuverable, have no propellers that might cause injury, and are also suited to inshore work<sup>94</sup>. Once the whale is farther offshore, sturdier craft are needed, manned by at least one observer in addition to the pilot. Boats are generally positioned flanking and to the rear of the whale. Keep engine speed low and constant. Where conditions (e.g., estuaries or inland waterways) inhibit effective herding operations, it may be preferable to secure the animal and tow it to sea.

Towing a cetacean requires skill and experience, as well as a suitable boat. Improperly placed ropes or slings can cut into the skin or prevent the animal from surfacing to breathe. A whale that suddenly makes a burst for the open sea may swamp a small boat or escape before it can be properly released from its harness. Accounts of reestranded animals with rope wounds around necrotic tails are testimony that not all towing attempts are successful. The first rule is to **tow head first**. Towing backwards by the tail can damage the flukes, dislocate vertebrae, and result in suffocation. If the animal is strong enough to withstand this treatment, a further danger awaits, as observed by Backus and Schevill<sup>2</sup> during attempts to rescue a stranded Cuvier's beaked whale:

*"...and being towed as it was, tail foremost, [it] swam shoreward when it swam...."*

Towing head-first and orienting the animal seaward may help prevent this from occurring. With all methods of towing, it is certain that a **whale, sensing freedom of movement in the water, may decide on its own course.**

Better than ropes, a harness with wide banding and substantial padding will help to distribute pressure due to the force of towing. For



© Geraci & Lounsbury 1993

**Fig. 6.11.** A method for towing utilizing a “rescue sheet” with quick-release fasteners, a swivel between lines from sling and main tow-line to reduce twisting, and a spring in the main tow-line to dampen speed surges.

example, a length of cloth or strapping can be draped over the back; the two ends are then passed behind and underneath the flippers (one on each side) and attached to the tow-line. This arrangement tends to lift the animal’s head when tension is applied. A similar procedure with more technical detail<sup>94</sup> (Fig. 6.11) incorporates a broad sheet for maximum distribution of pressure, a swivel to prevent the tow-line from twisting, and a spring in the tow-line to minimize speed surges inevitable in swells. **All ropes and harnesses must allow for rapid release** when the need arises.

The tow-line must be sturdy, long enough to keep the whale a safe distance from the engines, but short enough to allow maneuverability. A longer line will help keep the animal level and reduce its tendency to rise up and pitch forward into the water. Towing speed should not exceed 1 knot<sup>145</sup>. Stop intermittently (e.g., 20 seconds moving, 10 seconds stop) to allow the whale to breathe.

The animal can be placed in a flooded inflatable raft and towed<sup>31</sup>, or into a specially designed stretcher supported by two rafts or pontoons, which is then towed as a unit or fastened alongside a boat. Cetaceans can also be “towed” in a stretcher or sling fixed to the side of an adequately large boat (Fig. 6.3). A net sling has the advantages of minimum resistance and easy release<sup>9</sup>.

How far to drive or tow an animal offshore will depend largely on the topography of the region. A few kilometers will normally be enough if the beach is open, the coast straight and the water deep. Strong coastal currents and complex topography may require that the animal be towed a considerable distance offshore before it is released.

### Helicopters and Boats

Helicopters have been used to move animals off the beach quickly. In

one incident, 22 *Tursiops* were trapped by a receding tide in a bay on the South Island of New Zealand<sup>18</sup>. A cow and a calf were placed together in a sling, flown offshore, and tethered near a waiting fishing boat. All the remaining animals were transported in rapid succession and released in the vicinity of the tethered cow. When the operation was completed, the cow was released and the entire pod swam calmly into deeper water. The rescue was presumed to have been successful.

In a similar manner, small cetaceans can be carried on the decks of fishing boats and released at a suitable site<sup>36</sup>. Such methods have the advantage of moving animals directly to a specific location—one far enough offshore to discourage restranding. Where the stranding area is inaccessible to land vehicles, helicopters and boats may also be useful for moving animals to alternate holding or release sites.

### Observing and Monitoring

The success of a release can only be measured by knowing exactly what has happened to the animals. One cannot assume that a whale has survived simply because it has not reestranded.

Maintain visual contact as long as possible. In a few instances, an animal can be observed from shore, but most serious efforts will require sea-going vessels or aerial reconnaissance. Unfortunately, this is expensive and often difficult to arrange. Chemical lights that are visible up to a mile or more away can be used to track released animals at night. The lights come in a variety of colors and can be attached (using biodegradable cotton string) to the dorsal fin tag. Still, though logistically difficult, electronic tagging (satellite, VHF) is the only reliable means of determining whether the animal has fully recovered.

## 6.9. Transport to Care Facility

The same equipment and approach to moving a whale on the beach is used to load it for transport (Fig. 6.8). The success of the operation will depend on the type of vehicle that can be driven to the scene. Animals may be transported on thick foam pads. Close-cell foam is rigid and, because it does not absorb water, remains light; it is ideal for short-term transport. Open-cell foam, preferred for longer travel, is softer, contours easily to the animal's form, but will absorb water and become heavy. Some individuals may be more comfortable on their sides<sup>64</sup>. Specially constructed transport boxes are generally used for longer distances.

**Protect the animal from sun, wind, and exhaust fumes, and keep it cool and wet.** One or more representatives from the rehabilitation

center should be involved in the handling and transport since they ultimately share responsibility for the animal's health.

During transit to the rehabilitation center, attendants should monitor respiratory rate, record body temperature, and, if possible, collect blood samples and swabs for culture (see Chapter 10). This will expedite assessment of the animal's condition upon arrival, allowing therapy to begin with minimal delay.

## 6.10. Rehabilitation

### General Considerations

The care required to rehabilitate a stranded cetacean until it is well enough for release can strain a facility's endurance and budget. An isolation pool is necessary to avoid contaminating other animals, and a skilled team is needed for care and support. The institution bearing these costs may understandably shy away from your plea for help if previous efforts were unsuccessful, as they often are. To keep the doors open, and in the interest of humane care, **select animals for rehabilitation that have a reasonable chance of recovery**, and respect the decision of the accepting facility.

Small young specimens lifted from the beach soon after stranding are usually good rehabilitation candidates, because they can easily be transported and handled for diagnostic and therapeutic procedures. A coastal species such as *Tursiops truncatus* has reasonable prospects, whereas stranded *Delphinus delphis*, *Stenella* spp. and other pelagic forms seem to have more difficulty adjusting to captivity, although some have adapted successfully. A pelagic animal that has come ashore in a mass stranding, which as far as we know is a behavioral and not health-related phenomenon, may have a better chance than a singly stranded animal which is more likely to be sick and debilitated.

At the center, a new arrival may be placed in shallow water where it is more easily handled for support and medications. In water of any depth, **an animal unable to swim or remain upright will need assistance**. A stretcher fashioned out of neoprene (wet suit material) will provide additional buoyancy and protection against heat loss for an animal that is hypothermic<sup>144</sup>. Certain animals list to one side, either because they are weak, have problems with one lung, prefer to look to the surface with one eye, or simply because the pool currents force that position. More active animals may require some measures (i.e., attendants placed strategically to guide the animal) to prevent their colliding with pool walls.

Cetaceans often fare better in pairs or groups than alone. Social groupings are seldom possible unless the animal is part of a multiple stranding. The remaining option of **placing a newly arrived stranding alongside a colony animal combines the worst elements of poor husbandry and bad medical practices.**

A medical examination is performed as soon as the animal arrives at the facility so **therapy** can begin immediately. To **restore salt and water balance** caused by dehydration and shock, the animal can be placed for up to a week or so in brackish water of about 10 ppm, roughly equivalent to the salinity of body fluids, or in fresh water for a few hours at a time, in hopes that it will drink. Replacement fluids can also be given by stomach tube.

After a long time on the beach, larger specimens, such as pilot whales, may suffer poor blood circulation to vital organs including liver and muscle, which then malfunction. Rigorous intervention is required to control and reverse this condition—incipient shock. Sometime during the course of rehabilitation, cetaceans are oftentimes given **medications for stress**, as well as **antibiotics to control infections** and to prevent bacteria from invading what might now be a weakened subject.

#### **Nutrition**

A **rigorous nutritional program** may be required to restore and maintain the animal's health. First, it is necessary to restore fluid balance by tube-feeding fluids for a few days before giving whole fish or fish gruel. The effort needed for such a feeding schedule is demanding at first, but within a few days most patients will take fish or swallow the feeding tube with minimal help from one or two persons. Formulas for dependent calves have been developed but have not been as extensively tested as those for other marine mammals. However, preparations have been used successfully to rear a bottlenose dolphin that came ashore in Florida still bearing an umbilical cord<sup>138</sup> and an orphaned harbor porpoise at the Pt. Defiance Aquarium in Tacoma, Washington<sup>105</sup>.

Besides special nutritional needs, dependent calves require a **social setting** that is difficult and expensive to provide in captivity. Attempts to satisfy this need have included companion animals, such as pinnipeds and a steady stream of volunteers. Calves are also best provided with a choice of toys and gadgets, as long as the objects are too large to swallow.



### 6.11. Release Following Recovery (*see also* 6.8)

It may be months or a year or more before a cetacean is ready to be returned to sea. Criteria for judging suitability for release include medical evaluation, overall physical fitness including swimming and diving behavior, and the ability of the animal to feed on its own. There should be good evidence that any member of a highly social species will be able to interact with others of its kind (*see* Chapter 7). Any human-dependent behavior should be extinguished as part of the approach to preconditioning animals for release.

A young dependent cetacean has a poor chance of survival and still less of being successfully returned to sea. While rearing a calf to the point of physical independence might be feasible, “**social maturity**” **may be equally vital for survival** and perhaps impossible to attain in captivity. The host facility caring for an orphan may have to face accusations that the rescue effort was a veiled attempt to acquire an exhibit specimen.

### 6.12. Euthanasia

**Saving stranded animals is not always possible.** Sooner or later, the response team will find themselves faced with a situation where actions to save the victim are futile and prolong pain and suffering. Euthanasia then becomes the only humane option. Indications of a clear call for euthanasia include<sup>4,85,112,113</sup>:

- disabling injuries such as a dislocated or broken tailstock, penetrating wounds in the thorax or abdomen
- significant hemorrhage from the mouth, blowhole, genital opening or anus
- rectal temperature of 42°C or above
- blistering and sloughing of a major portion of the skin surface
- loss of reflexes (e.g., blowhole, palpebral, corneal, genital, and tongue withdrawal)
- loss of jaw tone, or protruding penis

Most methods of euthanasia, even when rapidly effective and considered humane, can be visually disturbing and even hazardous to onlookers. Discretion is essential. For the sake of other whales on the beach as well as the public, carry out the procedure behind a visual barrier when methods other than injection are used.

#### **Injection**

In many regions, the use of syringes, needles, and euthanasia

solutions is regulated. A veterinarian may be required to carry out the procedure. On the beach, access to and use of solutions must be strictly controlled. Certain preparations become viscous when cold and require special handling in a winter stranding.

A cetacean up to the size of a pilot whale can be euthanized by injecting a barbiturate or other lethal agent into a vein of the flippers, dorsal fin, flukes or caudal peduncle, or directly into the heart<sup>85,111,133</sup> or abdominal cavity<sup>144</sup>. The dose can be estimated from length measurements<sup>133</sup>. More than the calculated amount may be required if the needle is not seated well enough in the vein, and almost always when an animal is in shock, because circulation to the heart and brain is impaired.

At the point of death or immediately before, the tail may begin to stroke rhythmically in a swimming motion for a few seconds—a behavior known to the old whalers as “flurrying”. The action in water may be enough to propel the animal forward, even when held by handlers. The period of flurrying may be reduced or eliminated altogether when enough agent is given quickly, and prolonged if too little is injected or if it is released slowly. Flurrying is less apt to occur if the animal is first given a sedative. It is advisable to prepare onlookers for problems that might arise with lethal injections.

An attempt to euthanize a large whale by injection into the tail vein or peripheral vessels is likely to be unsuccessful as well as prohibitively expensive. On one occasion, personnel from the South Carolina Wildlife and Marine Resources Department<sup>79</sup> used 1500 mL of solution (worth \$1,200.00) before abandoning the approach. The animal, a 20-ton fin whale, was later euthanized quickly by an injection directly into the heart. This was accomplished using a “needle” fashioned from 1 m of stainless steel automobile brake line (available from auto supply stores in diameters ranging from 3/16" to 5/16"). The line was sharpened to a beveled point on one end, attached by means of a rubber sleeve to a large syringe on the other, and fitted inside with a plug (trocar). Subsequent observations suggested using a needle equal in length to about one-half the diameter of the whale, inserted through an incision (made following local anesthesia) penetrating the skin and blubber.

Although the precise entry point for each species has yet to be mapped, as a rule of thumb, **the heart can be reached by directing the needle from a point just behind the origin of the flipper to the same point on the opposite side of the body.** The heart can also be reached by inserting the needle to either side of the sternum, at a point just posterior to a line joining the base of the flippers (Fig. 6.12). The quantity

of solution required will depend on its type and strength and on the condition of the animal, but will be much less than if administered into peripheral vessels.

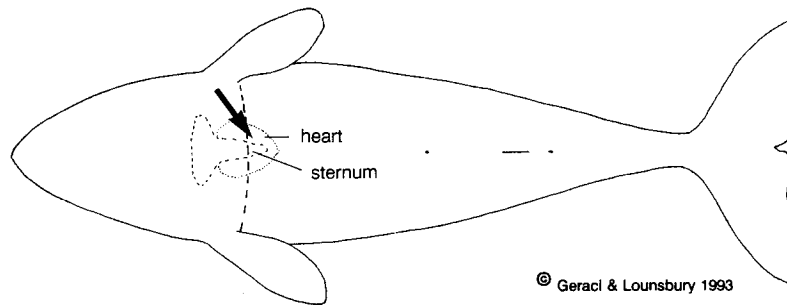
### **Explosives**

When euthanasia solutions or persons qualified to use them are unavailable, other methods can be employed, providing implementation is relatively painless and death is rapid. **Suffocation by obstructing the blowhole is not effective or humane**<sup>85,113</sup>. Explosives can be used to euthanize large whales humanely, although **the procedure must be supervised by an expert** and may require special arrangement with local authorities. When placed either deep in the whale's mouth<sup>18</sup> or on the cranium or nape and covered with sandbags and heavy rubber<sup>9,36</sup>, explosion can result in immediate death without excessive noise or damage to the carcass. This method, however, is dangerous if not done properly, may be prohibited by local statutes, and is likely to be met with resistance if attempted on a public beach. Strict precautions must be taken to keep observers at a safe distance.

### **Shooting**

**Smaller specimens can be killed quickly by shooting.** Use a firearm with a large bore (.303 or greater), high muzzle velocity, and a free, solid or jacketed bullet. The gun should be fired approximately 1 meter from the animal's head; a firearm discharged directly against the animal's skin may explode. Aiming down and backward through the blowhole to an imaginary point joining the flippers is sometimes recommended<sup>112,145</sup>, but if the shot is aimed too far backwards, the bullet must pass through the thickest part of the skull. Preferably, aim slightly upward through a point midway between the eye and the ear opening<sup>113,145</sup>, or shoot through the eye, angling the shot backwards and upwards toward a point above the opposite ear.

Shooting into the heart of a cetacean with a large girth will probably not result in a quick death. After efforts to rescue a Cuvier's beaked whale failed, a policeman fired 2 clips of bullets from a submachine gun into the animal in an attempt at euthanasia; the scapula was shattered, but the whale, weakened as it was by repeated strandings, was still alive<sup>2</sup>. Even in a small animal, **the site for bullet entry is critical**. Shooting is generally not an effective way of euthanizing whales over about 8 m in length<sup>111</sup> or a sperm whale of any size (due to their cranial anatomy)<sup>112,145</sup>, and may be inadvisable in areas where rocks increase the danger of ricochet.



**Fig. 6.12.** The base of the cetacean heart can be reached from either side of the sternum along a line connecting the base of the flippers.

### Exsanguination (Bleeding)

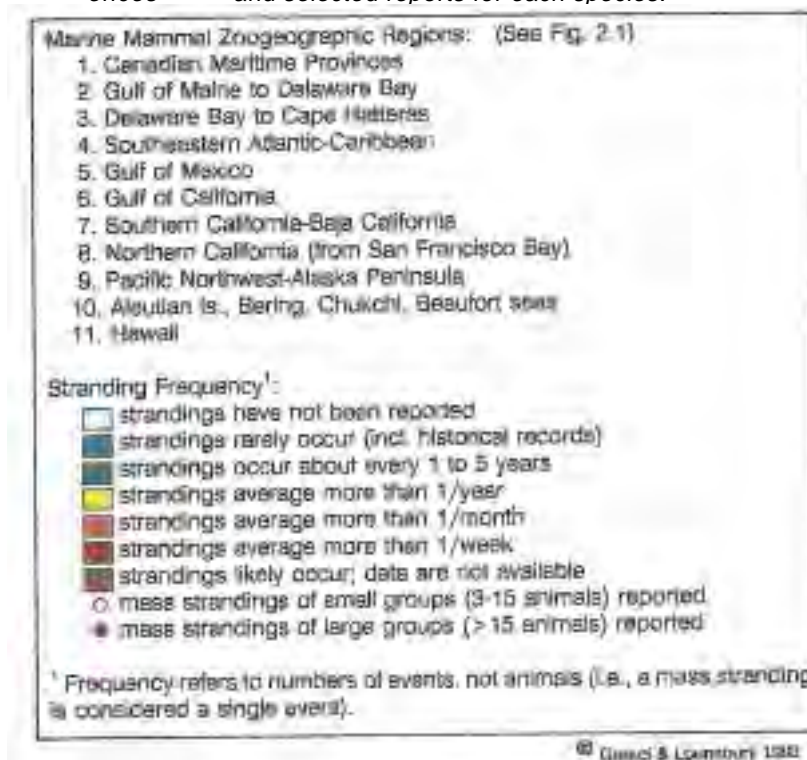
Exsanguination is an option when equipment required for other methods is unavailable, shooting unsafe, or there is no qualified person to administer a lethal injection. The technique is bound to generate adverse public reaction, even if the penetration site is first injected with local anesthetic.

The cetacean brain draws its principal blood supply not from the internal carotid arteries, as in most other mammals, but from a rete mirabile network that enters through the foramen magnum, protected deep in a mass of tissue in the back of the head. The Faroe Islanders, in their pilot whale harvest, have traditionally sought that site for cutting the blood supply to the brain. It is approached by directing a lance downwards from the back of the animal's neck. Inserted deep enough, the lance will sever both the vessels and spinal cord, and death will be quick. **Severing the carotids<sup>4</sup> is not the best approach to euthanasia.**

A lance can also be inserted deep into the thorax to penetrate the heart and cut major vessels. Proper entry sites for each whale species have not been mapped, but they generally lie on either side of the ventral midline, behind the origin of the flippers (Fig. 6.12). In some specimens, the location is marked by an obvious heartbeat. Observers should be prepared for the disturbing appearance of this procedure.

### 6.13. Cetaceans in U.S. and Adjacent Waters: A Brief Guide to Species Identification, Life History, and Stranding Frequency

*Note: Descriptions and life history data were taken from general references<sup>66,67,146</sup> and selected reports for each species.*



**Fig. 6.13.** Marine mammal zoogeographic regions in U.S. and adjacent waters and color key to stranding frequency.

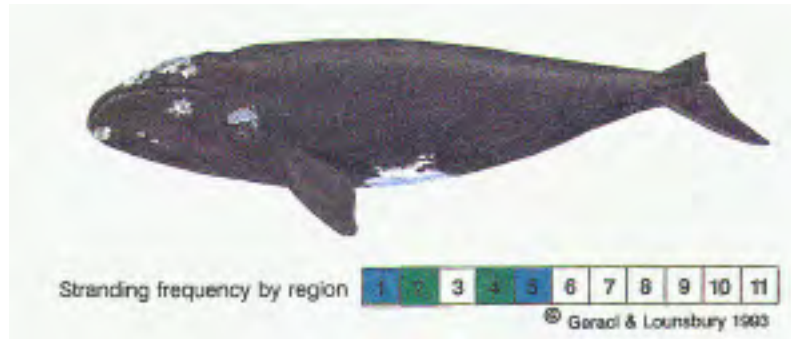
## Order Cetacea

### Suborder Mysticeti (Baleen Whales)

General characteristics: upper jaw with baleen plates rather than teeth; lower jaw robust, without teeth; blowholes paired.

#### Family Balaenidae (Right Whales)

General characteristics: body form robust; head large (>25 percent body length); upper jaw narrow and highly arched, with long baleen plates; dorsal fin absent; flippers broad; throat grooves absent.



**Northern right whale (*Eubalaena glacialis*)**<sup>25,32,61,86,95,108,115,116,124,149</sup>

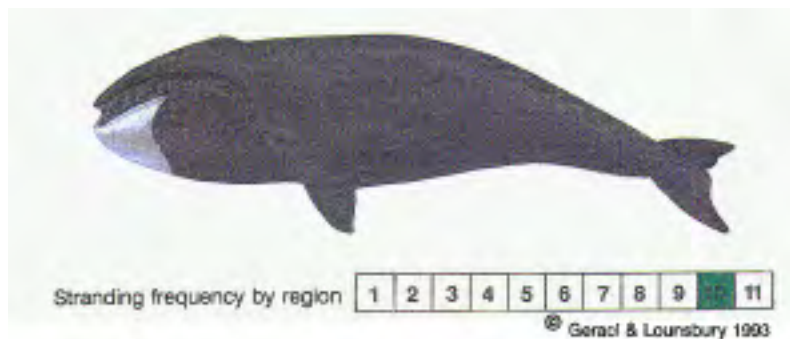
**Range:** 1 (May-Nov.); 2 (March-Nov.); 3-4 (Dec.-March); 5 (rare offshore, Jan.-March); 7-11 (rare).

**Size:** 5.5 m (neonate); 15-17 m, 45-60 t (adult).

**Distinguishing**

**features:** Lower jaw and head with numerous rough callosities; flippers large and rounded; skin mostly black, often with white patches on chin and belly; baleen plates (<2.8 m) dark with fine bristles, 200-270 plates/side.

**Habits:** Frequent coastal waters; females and calves inshore in areas 3-4, Jan.-March; migratory.



**Bowhead whale (*Balaena mysticetus*)**<sup>70,101,102,146,155</sup>

**Range:** 1 (Labrador northward); 10.

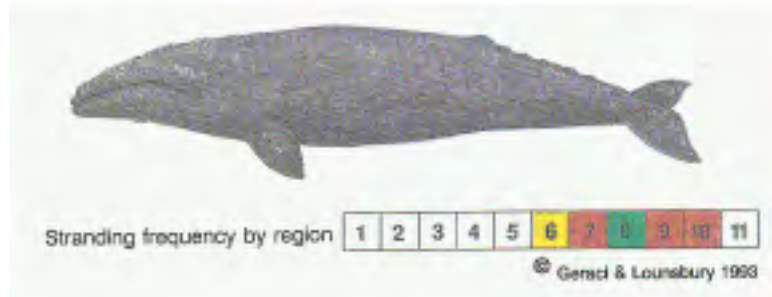
**Size:** 4-4.5 m (neonate); 6.1 m (weaning); 15-18 m, 70-100 t (adult).

**Distinguishing**

**features:** Skin smooth with no callosities; flippers broad and spatulate; body black with white on chin and sometimes peduncle; baleen plates (to 3.7-4.3 m) usually black, 230-360 plates/side.

**Habits:** Coastal and offshore, mostly along ice fronts and leads; migratory.

## Family Eschrichtiidae



**Gray whale** (*Eschrichtius robustus*)<sup>β,95,119,121,128,132,142,151,155</sup>

**Range:** 6, southern 7 (Jan.-Mar.); northern 7, 8, 9 (Mar.-May, Oct.-Dec., few in summer); 10 (June-Sept.).

**Size:** 4.6-5.0 m, 500 kg (neonate); 8.5 m (weaning); 12-14 m, 16-33 t (adult).

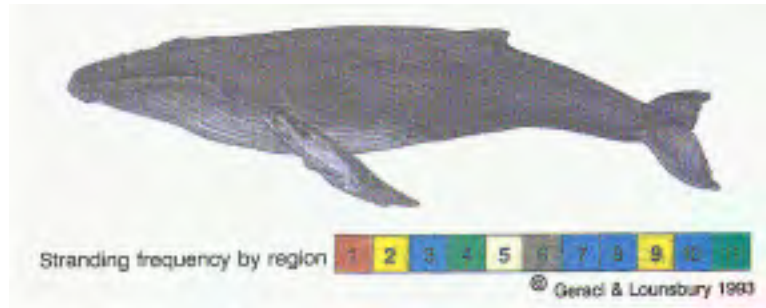
**Distinguishing**

**features:** Head narrow and tapering, no central ridge; rostrum with many pits, each with 1 hair; barnacle encrustations common, heavy on head; dorsal fin absent, series of low bumps (7-12) along posterior dorsal midline; skin mottled gray; baleen short (<0.4 m), white to yellowish, 140-180 plates/side; 2-5 creases on throat.

**Habits:** Coastal south of Alaska, more offshore in northern feeding grounds; strongly migratory.

**Family Balaenopteridae (Rorquals)**

General characteristics: body form more slender; head broad and flattened with 1 or 3 dorsal ridges; jaw not highly arched, baleen short to moderate in length; dorsal fin present; flippers narrow; throat grooves numerous.



**Humpback whale (*Megaptera novaeangliae*)**<sup>3,32,61,68,69,70,71,82,86,115,119,121,124,139,150,155</sup>

**Range:** 1-2 (peak summer); 3; 4 (Jan.-May); 5 (offshore, winter); 6 (year-round); southern 7 (winter); northern 7-10 (summer); 11 (peak Dec.-Apr.).

**Size:** 4.1-4.5 m (neonate); 7.6-8.5 m (weaning); 13-15 m, 30-40 t (adult).

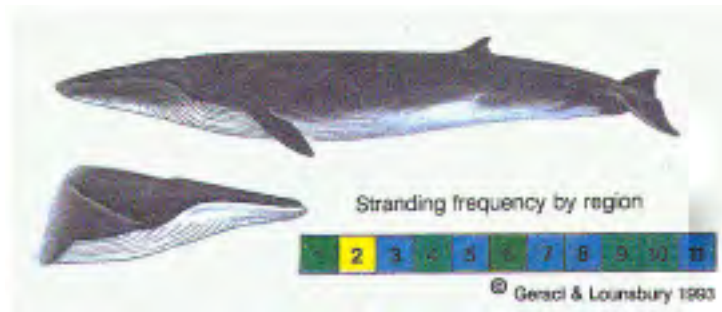
**Distinguishing**

**features:** Jaws and head with numerous knobs, often barnacle encrusted; fleshy mass near tip of lower jaw; dorsal fin on hump, 2/3 back on body; flippers large (to 1/3 body length); flukes long, with sawtoothed margin; body dark gray to black, white on throat; throat grooves (14-24) wide, extending to navel; baleen short (<0.7 m), black with dark brownish gray bristles, 270-400 plates/side.

**Habits:** Coastal in many areas; strongly migratory; often in groups of 2-10.







**Fin whale (*Balaenoptera physalus*)**<sup>32,38,61,69,82,86,95,115,116,119,121,124,128,142,149</sup>

**Range:** 1-northern 2 (spring-summer); 2-3 (year-round, peak Apr.-Oct.); 4-5 (winter, offshore); 6 (year-round); 8-10 (summer); 11 (winter).

**Size:** 6 m, 2 t (neonate); 11 m (weaning); 22-24 m, 60-70 t (adult).

**Distinguishing**

**features:** Head flattened and wedge-shaped; dorsal fin (to 0.6 m) falcate, about 2/3 back on body; strong dorsal ridge anterior to tail; body gray to brownish above, white below; lower right jaw white, left dark; baleen (<0.7 m) dark gray and yellow striped, but white to yellow anterior right side, 260-470 plates/side; throat grooves (56-100) extend at least to navel.

**Habits:** Generally pelagic, visiting coastal waters in many areas; migratory; occur singly or in small groups.



**Blue whale (*Balaenoptera musculus*)**<sup>61,69,95,119,121,124,128,148,149,153</sup>

**Range:** 1 (Apr.-Aug.); 2-3 (rare); 6 (spring and fall); 7-southern 9 (spring-fall); northern 9-southern 10 (summer).

**Size:** 7 m, 3 t (neonate); 21-26 m, 90-125 t (adult).

**Distinguishing**

**features:** Head broad, rostrum U-shaped, central ridge short; dorsal fin small (<0.25 m), 3/4 back on body; body dark blue-gray, with pale mottling; flippers pointed, white below; baleen (<0.9 m) black with dark, coarse bristles, 270-400 plates/side; tongue and palate black; throat grooves (55-88) extend at least to navel.

**Habits:** Pelagic, but may frequent coastal waters and shallow banks; migratory; occur singly or in groups of 2-3.



**Sei whale** (*Balaenoptera borealis*)<sup>37,61,69,70,95,115,124,128,149</sup>

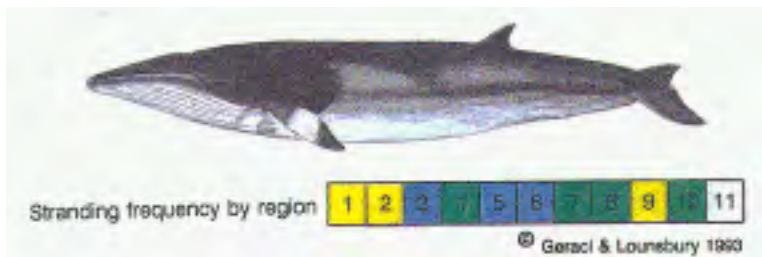
**Range:** 1-2 (May-Oct.); 3; 4; 5; 6 (peak Dec.-March); 8-9 (summer-fall); southern 10 (summer).

**Size:** 4.5 m (neonate); 9 m (weaning); 15 m (adult).

**Distinguishing**

**features:** Dorsal fin (0.3-0.6 m) falcate, about 2/3 back on body; body gray to blue-gray above, lighter below, often with light oval scars; flukes dark below; baleen (<0.8 m) black with fine white to grayish-brown bristles, 220-400 plates/side; throat grooves (32-60) ending between flipper and navel.

**Habits:** Pelagic; northward shift in summer; occur singly or in small groups.



**Minke whale** (*Balaenoptera acutorostrata*)<sup>3,32,70,86,95,115,119,121,124,128,129,142,155</sup>

**Range:** 1-2 (Apr.-Nov.); 3 (winter, offshore); 4; 5 (winter, offshore, uncommon); 6; 7 (winter); 8-9 (year-round); 10 (summer); 11 (Leeward Is.).

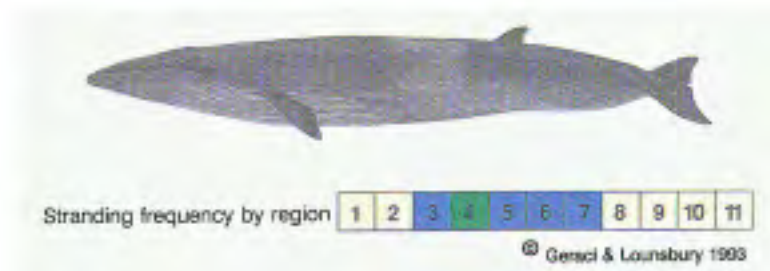
**Size:** 2.4-2.8 m (neonate); 5.0 m (weaning); 8.5-9.2 m, 6-9 t (adult).

**Distinguishing**

**features:** Head narrow and pointed with sharp median ridge; dorsal fin falcate, prominent; body black above, white below; may have chevron markings behind head; flipper small with broad white band; baleen short (<0.2 m), white to yellowish with fine white bristles, 230-325 plates/side; throat grooves (50-70) extending nearly to navel.

**Habits:** Frequent coastal regions, bays, estuaries, and offshore banks; northward shift in summer; often occur singly, sometimes in groups of 2-3.





**Bryde's whale** (*Balaenoptera edeni*)<sup>9,24,86,115,116,121,128,142</sup>

**Range:** 3; 4; 5; 6; 7 (rare); 11.

**Size:** 4 m (neonate); 7.1 m (weaning); 14 m (adult).

**Distinguishing**

**features:** Head with 3 prominent ridges anterior to blowhole; dorsal fin (to 0.5 m) strongly curved with pointed tip; body dark gray; baleen short (<0.4 m), dark gray with coarse bristles, 250-370 plates/side; throat grooves (50-70) extend at least to navel.

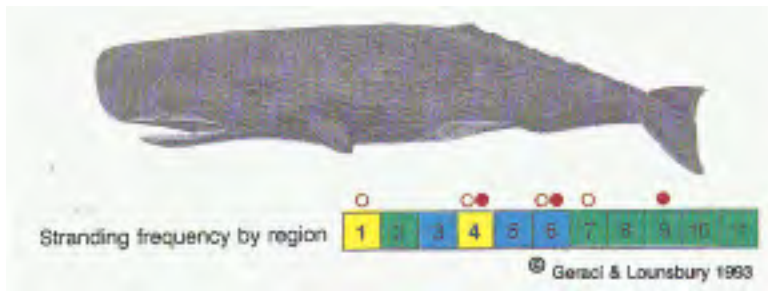
**Habits:** Variable habits: some pelagic populations migratory, some resident in nearshore waters; occur singly or in pairs.

### Suborder Odontoceti (Toothed Whales)

General characteristics: teeth present in one or both jaws (only in adult males of some species); blowhole single.

#### Family Physeteridae (Sperm Whales)

General characteristics: head blunt or squarish, with blowhole to left of midline; lower jaw narrow and underslung; functional teeth in lower jaw only.



**Sperm whale** (*Physeter catodon*)<sup>9,32,35,61,69,82,86,95,103,115,119,121,124,128,132,136,142,155</sup>

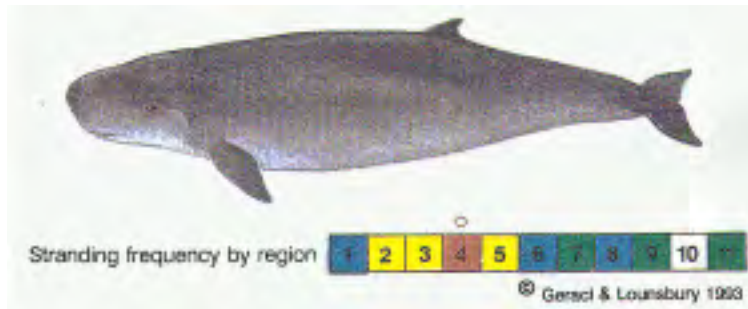
**Range:** 1-2 (summer-fall); 3; 4; 5; 6 (southern); 7-8 (peak Nov.-Apr.); 9 (spring-fall); southern 10 (summer, males); 11 (year-round).

**Size:** 3.5-5 m, 1 t (neonate); 6.7 m, 2.7 t (weaning); 11-13 m, 12-18 t (adult female); 15-18 m, 36-68 t (adult male).

**Distinguishing**

**features:** Huge square head with blowhole near left tip; lower jaw narrow with large conical teeth; dorsal fin hump-like, followed by smaller bumps along dorsal ridge; flippers small and blunt; body dark brownish gray, skin "corrugated;" throat with short furrows. Teeth: 0/18-25 each side.

**Habits:** Generally pelagic; highly social, sexually segregated herds of up to 40-50; migratory, with larger males moving into higher latitudes, females and juveniles usually remaining south of 50° N; old males solitary.



**Pygmy sperm whale (*Kogia breviceps*)**<sup>16,32,61,82,86,115,116,119,121,128,132,136,142</sup>

**Range:** 1-2 (rare north of Cape Cod); 3; 4; 5; 6; 7; 8; southern 9; 11.

**Size:** 1.0-1.2 m, 55 kg (neonate); 3.0-3.7 m, 360-400 kg (adult).

**Distinguishing**

**features:** Body chunky, tapering to narrow tail stock; small lower jaw with sharp curved teeth; "false gill" marking posterior to eye; dorsal fin small (<0.2 m), about 2/3 back on body; flippers short and broad, located forward on body; no throat creases; body dark blue-gray to brownish on back, lighter on sides, white on belly. Teeth: 0/12-16 each side.

**Habits:** Pelagic; occur singly or in small groups.



**Dwarf sperm whale (*Kogia simus*)**<sup>16,32,80,82,86,115,121,136,142</sup>

**Range:** 3; 4; 5; 7 (rare further north); 11.

**Size:** 1.0 m, 46 kg (neonate); 2.1-2.7 m, 140-280 kg (adult).

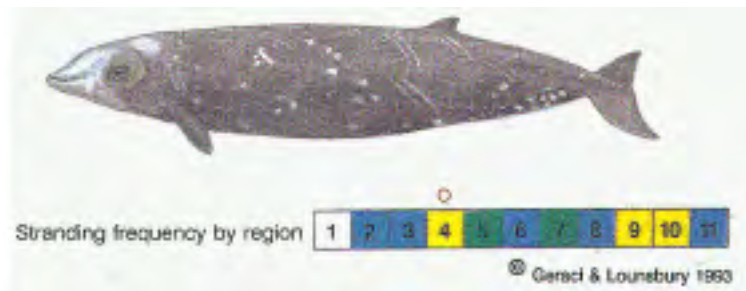
**Distinguishing**

**features:** Similar to *K. breviceps* but body smaller, dorsal fin taller and near midback; several short creases in throat; upper jaw occasionally with 1-3 pairs of teeth. Teeth: 0-3/8-11 each side.

**Habits:** Pelagic; occur singly or in small groups.

### Family Ziphiidae (Beaked Whales)

General characteristics: teeth (1 or 2 pairs) in lower jaw only; beak distinct, lower jaw often extending beyond upper; throat with two creases forming a "V"; flippers small; median notch in flukes indistinct or absent; dorsal fin small, more than 1/2 way back on body; wide crescent-shaped blowhole.



**Cuvier's beaked whale** (*Ziphius cavirostris*)<sup>32,35,56,82,86,95,115,119,121,128,142,155</sup>

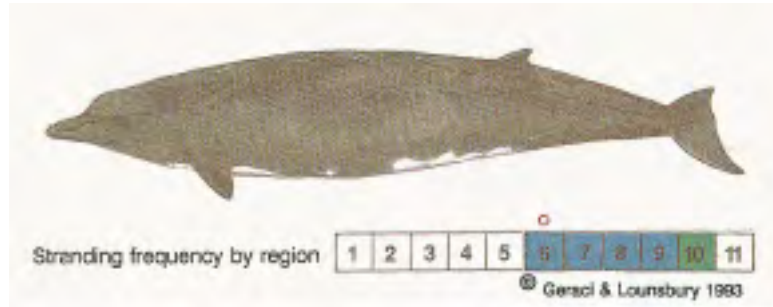
**Range:** 2-3 (summer); 4; 5; 6; 7; 8; 9; 10 (Aleutians); 11 (rare).

**Size:** 2-3 m (neonate); 6.7-7 m, 2-3 t (adult).

**Distinguishing**

**features:** Forehead sloping onto poorly defined beak; depression behind blowhole; dorsal fin about 2/3 back on body; lower jaw of adult males with one pair of conical teeth protruding from tip (unerupted in females and juveniles); color variable, gray to brown to tan to white, lighter with age; white scratches and round scars common.

**Habits:** Pelagic; occur singly or in groups of up to 20-30.



**Baird's beaked whale (*Berardius bairdii*)**<sup>6,95,132,142,149,155</sup>

**Range:** 7-8 (peak June-Oct.); 9 (Apr.-Oct.); 10 (winter).

**Size:** 4.5 m (neonate); 10-13 m, 10 t (adult).

**Distinguishing**

**features:** Body long and rotund; melon prominent, steeply sloping to long cylindrical beak; dorsal fin small, triangular, >2/3 back on body; adults with 2 pairs of laterally flattened teeth near tip of lower jaw, anterior pair visible with mouth closed; throat creases to 70 cm long, some with small central crease; color black to brown to gray with white patches ventrally; heavily scarred.

**Habits:** Pelagic; occur in pods of 2-20 with some segregation of sexes.



**Northern bottlenosed whale (*Hyperoodon ampullatus*)**<sup>61,76,124,128</sup>

**Range:** 1 (year-round, peak fall-winter); 2 (occasional, fall-winter).

**Size:** 3.6 m (neonate); 8-10 m (adult).

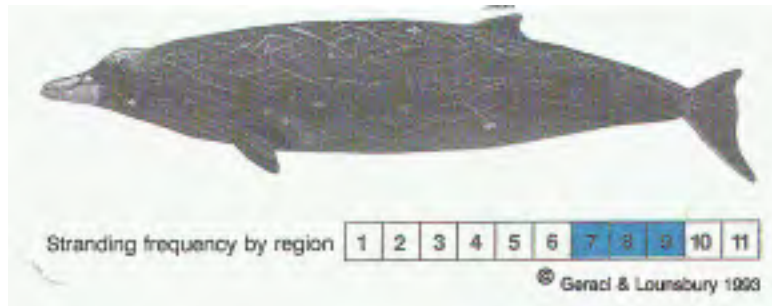
**Distinguishing**

**features:** Body robust; melon bulbous, sloping sharply to a prominent beak; lower jaw with 1 pair of teeth at tip (erupted in adult males only), not visible with mouth closed; dorsal fin falcate, about 2/3 back on body; body black to brown above, lighter below, with various lighter markings in adults; head of adults light.

**Habits:** Pelagic; occur singly or in groups of 2 to 4.

**Mesoplodon spp.**<sup>77,78</sup>

General characteristics in addition to those of the Ziphiidae: only one pair of laterally flattened teeth, erupted in adult males only, often on an arched prominence on the lower jaw; body generally spindle-shaped with a small head and narrow tailstock; color dark above and lighter below; blowhole in depression behind the melon, which slopes to a long beak; body wall with pocket-like depressions for flippers; adults, particularly males, frequently heavily scarred. NOTE: Several species of this genus may be found in North American waters and are rare, not well-known, and difficult to identify in the field. Identification of females and immature males, in which teeth are unerupted, is even more difficult.

**Hubb's beaked whale (*Mesoplodon carlhubbsi*)**<sup>77,95,119,121,132</sup>

**Range:** 7; 8; southern 9.

**Size:** 2.5 m (neonate); 5.3 m, 1.5 t (adult).

**Distinguishing**

**features:** Adult males with notable white raised area anterior to blowhole; tip of beak white; teeth massive, flat and wide, protruding from raised arches about 1/2 way from tip of jaw to angle of mouth; throat creases long; body heavily scarred.

**Habits:** Pelagic; occur in small groups.

**Stejneger's beaked whale (*Mesoplodon stejnegeri*)**<sup>77,95,119,128,155</sup>

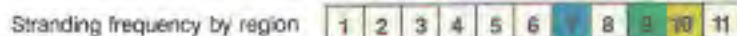
**Range:** 7; 8; 9; 10.

**Size:** 5.3 m (adult).

**Distinguishing**

**features:** Teeth large and flattened, protruding from arches at about middle of lower jaw and tilting slightly forward; top of head has no raised white area; back with ridge from dorsal fin to flukes.

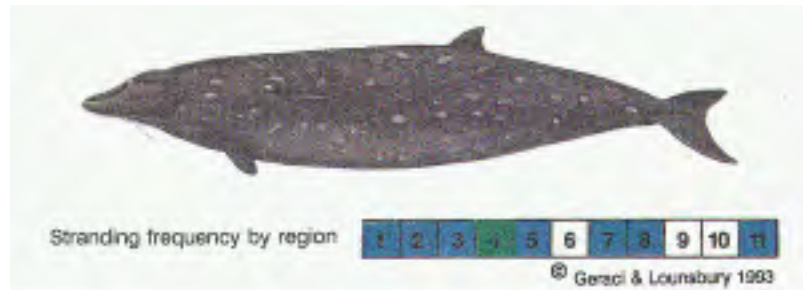
**Habits:** Pelagic; occur in small groups.

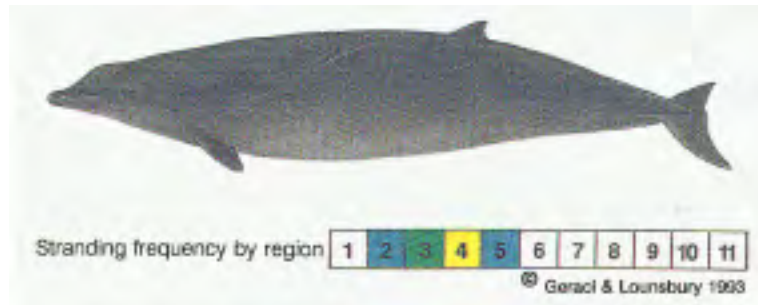




**Hector's beaked whale** (*Mesoplodon hectori*)<sup>77,78</sup>**Range:** 7.**Size:** 4.3-4.5 m (adult).**Distinguishing****features:** Beak short; teeth small and triangular, near tip of lower jaw.**Habits:** Pelagic.

Stranding frequency by region

**Blainville's beaked whale** (*Mesoplodon densirostris*)<sup>32,61,77,78,82,86,115,121,124</sup>**Range:** 1; 2; 3; 4; 7; 8; 9; 10; 11.**Size:** 4.5-4.7 m, 1 t (adult).**Distinguishing****features:** Forehead flattened with marked depression anterior to blowhole; teeth protrude from front edge of prominent arch near corner of mouth and tilt forward; skin of adults scarred; body dark on back, lighter gray ventrally and on sides, with blotchy gray to pinkish markings and white oval scars.**Habits:** Pelagic; occur in small groups.



**Gervais' beaked whale** (*Mesoplodon europaeus*)<sup>32,77,78,86,115,148</sup>

**Range:** 2; 3; 4; 5.

**Size:** 2.1 m (neonate); 4.5-5.2 m (adult).

**Distinguishing**

**features:** Body laterally compressed; head extremely small with narrow beak; teeth triangular, about 1/3 back from tip of lower jaw.

**Habits:** Pelagic; occur in small groups.

**True's beaked whale** (*Mesoplodon mirus*)<sup>32,61,77,78,86,115,124</sup>

**Range:** 1 (summer); 2; 3; 4.

**Size:** 5.1-5.4 m, 1.4 t (adult).

**Distinguishing**

**features:** Body heavy, with depression behind blowhole and slightly bulging melon; teeth small, triangular and compressed, located near tip of lower jaw.

**Habits:** Pelagic.



**Sowerby's beaked whale** (*Mesoplodon bidens*)<sup>11,61,68,77,78,86,128</sup>

**Range:** 1; 2; 5 (rare).

**Size:** 2.4 m (neonate); 3 m (weaning); 5 m (adult).

**Distinguishing**

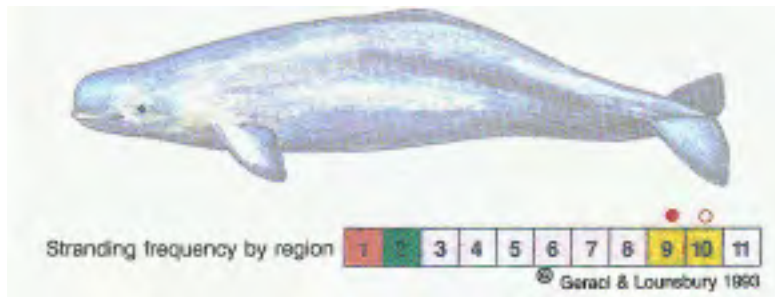
**features:** Teeth small and pointed, about 1/2 way from tip of lower jaw to corner of mouth.

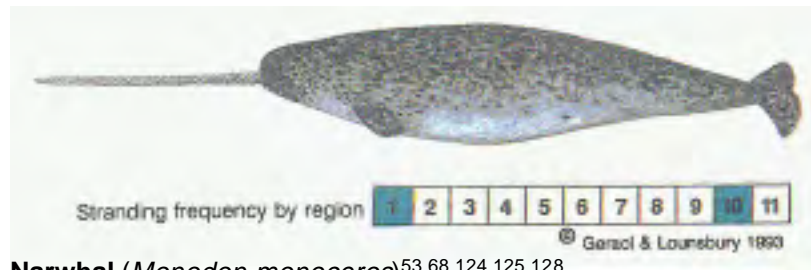
**Habits:** Pelagic.



**Ginko-toothed beaked whale (*Mesoplodon ginkodens*)<sup>77</sup>****Range:** 7 (rare).**Size:** 2.1 (neonate); 5.2 m, 1.5 t (adult).**Distinguishing****features:** Upper jaw narrow and pointed; teeth large, wide and flattened, located about halfway between tip of lower jaw and the corner of mouth, on top front edge of prominent arch; area anterior to blowhole neither markedly depressed nor raised; body dark with numerous white blotches and oval scars on belly.**Habits:** Pelagic.**Family Monodontidae**

General characteristics: dorsal fin absent, replaced by low dorsal ridge; flippers paddle-shaped; melon prominent; beak indistinct.

**Beluga whale (*Delphinapterus leucas*)<sup>13,15,32,54,123,124,128,155</sup>****Range:** 1 (Labrador northward; St. Lawrence River estuary, Gulf of St. Lawrence); 2 (occasional strays, winter); northern 9; 10.**Size:** 1.3-1.6 m, 50-80 kg (neonate); 3.0-4.0 m, 500-900 kg (adult female); 4.0-4.5 m, 900-1400 kg (adult male).**Distinguishing****features:** Body rotund with small head, bulbous melon, and well-defined flexible neck; beak short; color dark gray in juveniles, light gray to white in adults. Teeth: 8-11/8-9 each side.**Habits:** Coastal in bays, estuaries and rivers; migratory along leads; winter offshore in pack ice; gregarious in small to large groups.



**Narwhal** (*Monodon monoceros*)<sup>53,68,124,125,128</sup>

**Range:** 1 (Labrador northward); 10 (rare).

**Size:** 1.5-1.7 m, 80 kg (neonate); 4.2-4.7 m, 1000-1600 kg (adult).

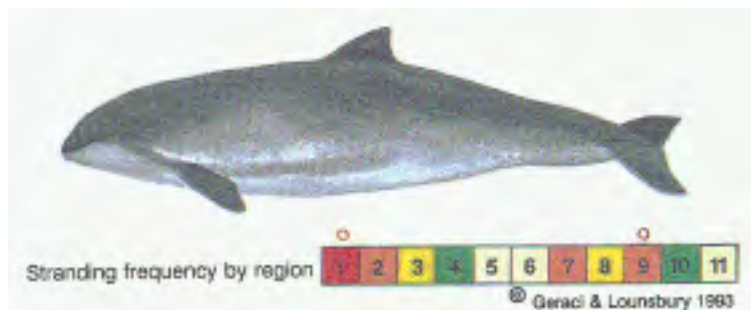
**Distinguishing**

**features:** Body rotund with small head and no beak; males with a spiral tusk up to 3 m long; newborn blotchy gray; adults dark purplish black with white mottling on backs and sides and white bellies, becoming lighter with age.

**Habits:** Usually associated with pack ice and deep water; occur singly or in small to large groups.

**Family Phocoenidae (Porpoises)**

General characteristics: body small with triangular or rounded dorsal fin; snout rounded with indistinct beak; teeth spade-shaped.



**Harbor porpoise** (*Phocoena phocoena*)<sup>3,32,40,61,86,115,119,121,124,128,132,148,149,155</sup>

**Range:** 1, 2 (common inshore Apr.-Oct.); 3; 4 (rare); northern 7; 8; 9; 10 (southern in winter).

**Size:** 0.7-0.9 m (neonate); 1.0-1.1 m (weaning); 1.4-1.7 m, 60-90 kg (adult).

**Distinguishing**

**features:** Dorsal fin broad-based, low and triangular; flippers small and blunt; back, flippers, flukes and tail stock black to brown; sides gray, belly white. Teeth: 23-28/22-26 each side.

**Habits:** Coastal in bays, estuaries and rivers; frequent offshore banks; occur singly, in pairs or small groups.



**Dall's porpoise** (*Phocoenoides dalli*)<sup>3,40,95,119,121,132,155</sup>

**Range:** 7 (inshore winter-spring); 8-southern 10 (year-round).

**Size:** 1.0 m, 25 kg (neonate); 1.8-2.2 m, 100-200 kg (adult).

**Distinguishing**

**features:** Heavy body with small head, mouth, flippers and flukes; tail stock with prominent dorsal and ventral keels; distinct black and white color pattern. Teeth: 23-28/22-26 each side.

**Habits:** Pelagic; nearshore in deep water; occur in small groups.

**Vaquita** (*Phocoena sinus*)<sup>40,142</sup>

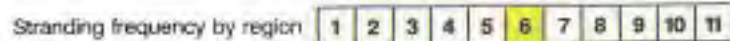
**Range:** 6 (northern, rare).

**Size:** 0.7 m (neonate); 1.3-1.5 m (adult).

**Distinguishing**

**features:** Similar to harbor porpoise; range limited to northern Gulf of California.

**Habits:** Coastal.



### Family Delphinidae

General characteristics: teeth in both jaws (except for *Grampus*); teeth conical, not spade-shaped; dorsal fin usually well-developed; beak variable.



**Killer whale (*Orcinus orca*)**<sup>3,10,32,61,72,82,95,115,119,121,124,128,149,155</sup>

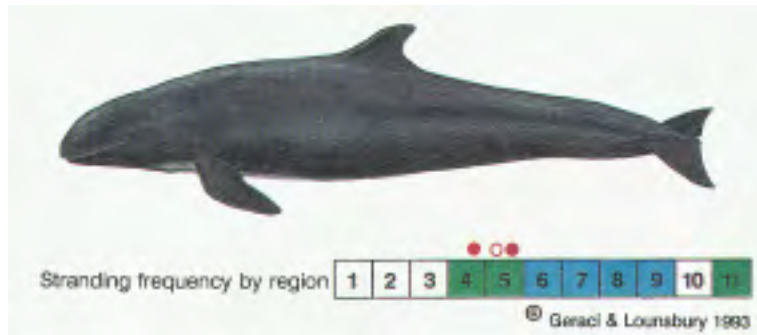
**Range:** 1 (inshore peak spring-summer); 2 (occasional); 3-5 (uncommon); 6; 7; 8; 9 (inshore year-round); 10 (north of Bering Strait in summer only); 11 (rare).

**Size:** 2.1-2.5 m, 180 kg (neonate); 4 m (weaning); 7-8 m, 4000 kg (adult female); 8-9.5 m, 8000 kg (adult male).

**Distinguishing**

**features:** Body heavy with blunt, indistinct beak; dorsal fin at midback, high (to 1.8 m) and triangular in males, smaller and more curved in females; flippers broad and rounded; striking black and white coloration with oval white patch above and behind eye; teeth large, squarish in cross-section. Teeth: 8-11/8-11 each side.

**Habits:** Frequent inshore visitors; regularly coastal only in 9-10; occur commonly in pods of 10-40; strong social organization.



**False killer whale** (*Pseudorca crassidens*)<sup>3,35,82,86,115,119,128,136,142</sup>

**Range:** 3; 4; 5; 6 (occasional); 7; 8-9 (occasional); 11.

**Size:** 1.7-2.0, 80 kg (neonate); 5.0 m (adult female); 5.5-6.0 m, 1360 kg (adult male).

**Distinguishing**

**features:** Body long and slender; head rounded and tapering with no beak and long straight mouthline; flipper long, narrow and pointed, with notable hump at middle of leading edge; dorsal fin near midbody, moderately high and falcate; color black except for variably distinct gray anchor-shaped area between flippers. Teeth: 8-11/8-11 each side.

**Habits:** Pelagic; form large schools.



**Pygmy killer whale** (*Feresa attenuata*)<sup>82,86,115,116,128,136</sup>

**Range:** 4; 5; 11.

**Size:** 2.4-2.7 m (adult).

**Distinguishing**

**features:** Body slender with rounded head, no beak, and straight mouthline; dorsal fin falcate, placed at midback; flippers with convex anterior margin, rounded at tip; color dark on back, lighter on sides and belly; anchor-shaped light area between flippers, white patches on abdomen, lips and chin. Teeth: 8-11/11-13 each side.

**Habits:** Pelagic; occur in small groups.



**Melon-headed whale** (*Peponocephala electra*)<sup>82,142,148</sup>

**Range:** 4 (rare); 7 (rare); 11.

**Size:** 2.7 m (adult).

**Distinguishing**

**features:** Body slender; head triangular from above; beak indistinct; mouthline long and straight; flippers with convex anterior margin, pointed at tips; dorsal fin falcate, slender, and sharply pointed; color black above with anchor-shaped gray patch on throat, and white areas on abdomen and lips. Teeth: 21-25/21-25 each side.

**Habits:** Pelagic; occur in small groups to large herds.



**Long-finned pilot whale** (*Globicephala melas*)<sup>32,35,61,86,115,122,123,124,128,149</sup>

**Range:** 1; 2; 3; 4 (northern, rare).

**Size:** 1.6-2.0 m, 70-90 kg (neonate); 2.4 m (weaning); 4.5-5.0 m, 800-1200 kg (adult female); 4.5-6 m, 1000-1800 kg (adult male).

**Distinguishing**

**features:** Head with bulbous melon and indistinct beak; dorsal fin long-based, low, and strongly curved with rounded tip, located forward on the body; pectoral fins long (>1/5 body length) and sickle-shaped; color black with light anchor-shaped patch on throat and variable lighter markings on belly. Teeth: 8-11/8-11 each side.

**Habits:** Pelagic, moving inshore late summer and fall; highly social, in small groups to large herds.





**Short-finned pilot whale (*Globicephala macrorhynchus*)**<sup>32,35,60,82,86,115,119,121,128,142</sup>

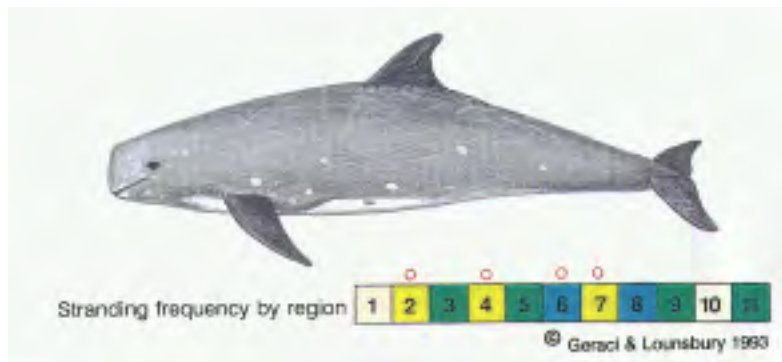
**Range:** 2 (southern)-3 (summer); 4; 5; 6; 7 (inshore peak late winter/early spring); 8-9 (uncommon); 11.

**Size:** 1.5 m, 60 kg (neonate); 4-5 m, 600-1200 kg (adult female); 5-6 m, 1200-1800 kg (adult male).

**Distinguishing**

**features:** Similar to above, but with shorter (<1/5 body length) pectoral fins. Teeth: 7-9/7-9 each side.

**Habits:** Generally pelagic; highly social, in small groups to large herds.



**Risso's dolphin (*Grampus griseus*)**<sup>3,32,35,82,86,115,119,121,128,132,142,148,149,155</sup>

**Range:** 1-2 (uncommon north of Cape Cod); 3; 4; 5; 6; 7-8 (year-round); southern 9 (spring-fall); 11 (rare).

**Size:** 1.2-1.6 m (neonate); 3-4 m, 300-600 kg (adult).

**Distinguishing**

**features:** Body heavy anteriorly, tapering to narrow tail stock; head blunt with no distinct beak, but with unique vertical crease in melon; dorsal fin tall and pointed, near midback; flippers long and pointed; color light to dark gray with numerous white scars, becoming lighter with age; flippers, flukes and dorsal fin darker; no teeth in upper jaw. Teeth: 0/3-8 each side.

**Habits:** Pelagic; occur singly or in small to large groups.



**Pacific white-sided dolphin (*Lagenorhynchus obliquidens*)**<sup>84,95,119,121,132,155</sup>

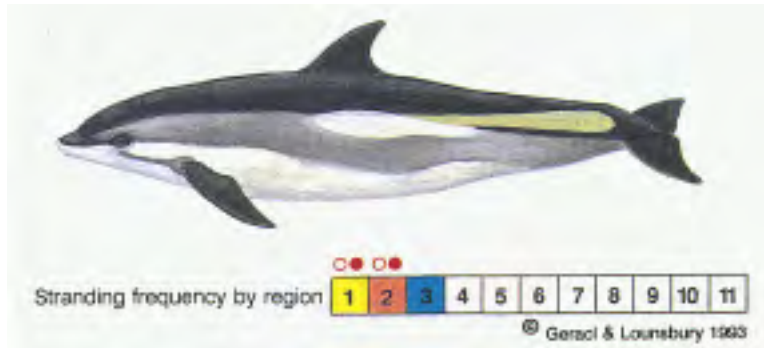
**Range:** 6 (southern); 7 (peak fall-spring); 8; 9; 10 (Aleutian Is., summer).

**Size:** 0.8-1.0 m (neonate); 2.2-2.3 m, 150 kg (adult).

**Distinguishing**

**features:** Head short with short beak; flippers long and tapered; dorsal fin at about midback, tall, sharply hooked, and bicolor; color pattern distinct, with black back, elongated light gray area above flipper and light stripe along side, and white belly; beak dark with stripe from mouth to flipper. Teeth: 23-32/24-31 each side.

**Habits:** Generally pelagic; nearshore in deep water; form large schools.



**Atlantic white-sided dolphin (*Lagenorhynchus acutus*)**<sup>32,61,123,124,128,149</sup>

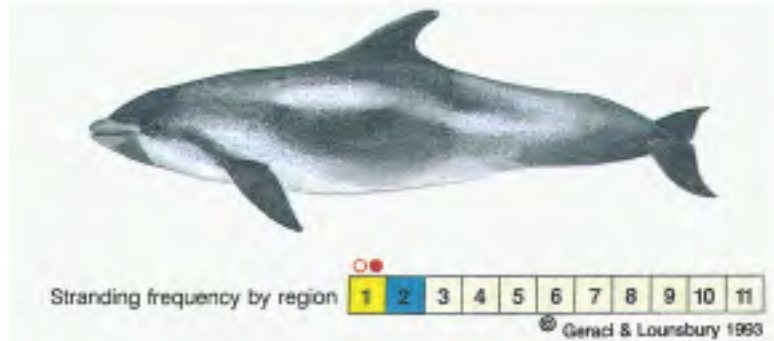
**Range:** 1-2 (common inshore spring-autumn); 3 (uncommon).

**Size:** 1.0-1.3 m (neonate); 2.4-2.7 m, 200-240 kg (adult).

**Distinguishing**

**features:** Beak short; dorsal fin tall and sharply falcate; flippers strongly curved and pointed; tail stock with prominent dorsal and ventral keels; sides of body with distinct elongated white patch followed by one of tan or yellow; flippers, back, and short beak black, dorsal fin black and gray, flank lighter gray, belly white; dark stripe from flipper to dark part of body. Teeth: 30-40/30-40 each side.

**Habits:** Pelagic but may feed in deep water close to shore; may occur singly, in small groups or in schools of hundreds.



**White-beaked dolphin (*Lagenorhynchus albirostris*)**<sup>123,124,128,148,149</sup>

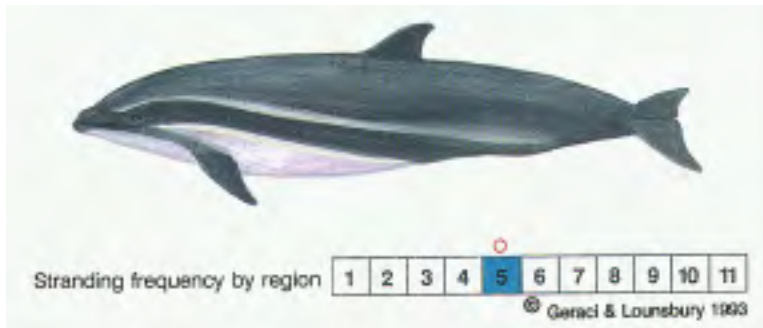
**Range:** 1-2 (Nov.-June).

**Size:** 1.1-1.3 m (neonate); 3.0-3.2 m, 275 kg (adult).

**Distinguishing**

**features:** Large size; dorsal fin tall and falcate; flippers slightly curved; beak often white or light gray; body dark on back and sides, light gray to white below, with white markings on back and sides; dorsal fin black; dark color of flippers continuous with that of body. Teeth: 22-28/22-28 each side.

**Habits:** Pelagic; occur in small groups or large schools to 1500.



**Fraser's dolphin (*Lagenodelphis hosei*)**<sup>55,86,115,128</sup>

**Range:** 4-5 (rare); 11.

**Size:** 1 m (neonate); 2.4 m (adult).

**Distinguishing**

**features:** Body heavy; beak short; flippers small; dorsal fin triangular, small and pointed; tail stock with dorsal and ventral keels; back blue-gray, belly white; adults with dark stripe from rostrum to anus. Teeth: 40-44/39-44 each side.

**Habits:** Pelagic; occur in small groups to large schools.



**Northern right whale dolphin (*Lissodelphis borealis*)**<sup>89,119,132,148</sup>

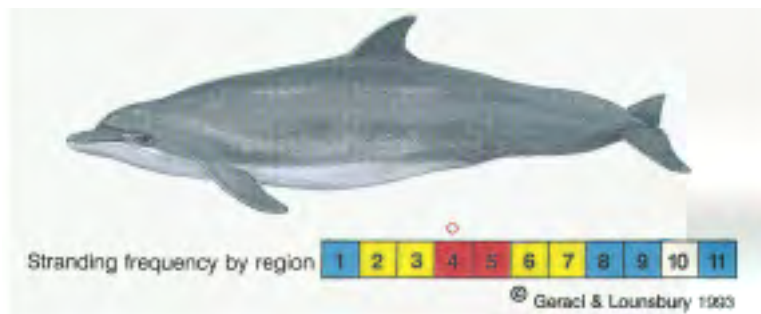
**Range:** 7 (inshore winter-spring); 8 (offshore year-round); southern 9 (uncommon).

**Size:** 0.8-1.0 m (neonate); 2.2-2.3 m (adult female); 2.6-3.0 m (adult male); 90 kg (average adult).

**Distinguishing**

**features:** Body slender and smooth; no dorsal fin; slender beak demarcated by faint crease; long straight mouthline; body mainly black, some white on ventral surface and near tip of lower jaw. Teeth: 37-49/37-49 each side.

**Habits:** Generally pelagic; nearshore in deep water; forms large (>100) herds.



**Bottlenose dolphin (*Tursiops truncatus*)**<sup>32,35,82,86,107,115,116,121,123,124,128,136,142,149</sup>

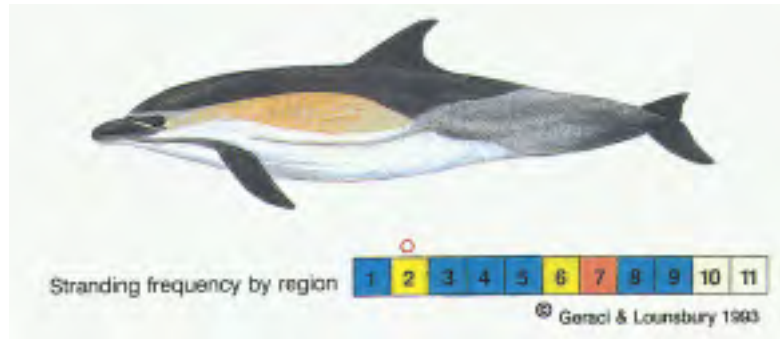
**Range:** 1-2 (summer offshore, uncommon); 3; 4; 5; 6; 7 (rare further north); 11.

**Size:** 1-1.3 m, 12-25 kg (neonate); 2.2-3.0 m, 140-240 kg (adult coastal form); 3.3-3.8 m, 250-650 kg (adult offshore form).

**Distinguishing**

**features:** Body robust; head with distinct thick beak; dorsal fin moderately high and falcate, near midback; flippers tapering to point; body gray to black above, becoming lighter ventrally. Teeth: 20-26/18-24 each side.

**Habits:** Frequents bays and estuaries in southern regions; generally offshore in areas 1-3.



**Common dolphin** (*Delphinus delphis*)<sup>32,61,68,86,95,115,119,121,124,128,132,142</sup>

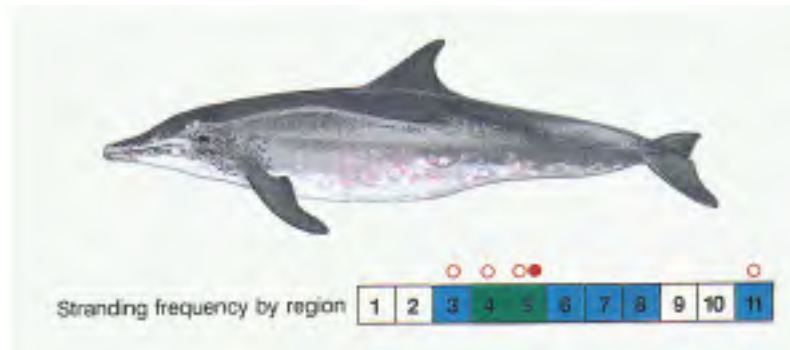
**Range:** 1 (summer); 2; 3; 4; 5; 6; 7 (year-round); 8 (uncommon); 9 (rare).

**Size:** 0.8-1.0 m (neonate); 2.3-2.5 m, 80-135 kg (adult).

**Distinguishing**

**features:** Beak well-defined; dorsal fin tall and pointed, triangular to falcate, near midback; body with complex yellow/tan and gray crisscross pattern on sides; back black, belly white; beak often black with white tip; narrow black stripe from flipper to mid lower jaw and from eye across base of melon. Teeth: 40-50/40-50 each side.

**Habits:** Generally pelagic; commonly in schools of about 50, sometimes to 1,000.



**Rough-toothed dolphin** (*Steno bredanensis*)<sup>35,82,86,115,116,121,136,142</sup>

**Range:** 3-5 (uncommon); 7 (uncommon); 11.

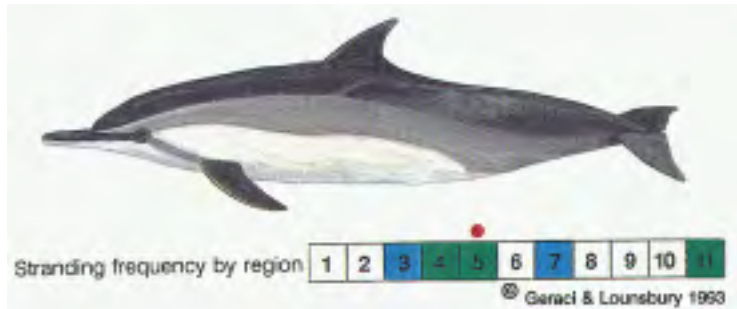
**Size:** 2.4-2.7 m, 130-160 kg (adult).

**Distinguishing**

**features:** Forehead sloping without crease to long slender beak; dorsal fin tall and falcate with long base; flippers large and tapered; color dark gray or purple-brown with pink or yellowish white spots on sides; belly and lips white; light scratches, circular scars common. Teeth: 20-27/20-27 each side.

**Habits:** Pelagic; generally occurs in small groups.

**NOTE:** Dolphins of the genus *Stenella* have long slender beaks, many small teeth, and various patterns of stripes and spots. There is great variation among stocks, making identification difficult.



**Spinner dolphin** (*Stenella longirostris*)<sup>35,82,86,115,116,121,128,136</sup>

**Range:** 4-5 (common); southern 7; 11.

**Size:** 0.7-0.8 m (neonate); 1.8-2.2 m, 75-95 kg (adult).

**Distinguishing**

**features:** Body slender; head with long narrow beak; dorsal fin triangular to falcate; body dark gray dorsally, lighter on sides, white on belly; beak dark on top, white below, with black tip and black lips; black stripe from flipper to eye. Teeth: 46-65/46-65 each side.

**Habits:** Pelagic and coastal; daytime in shallow bays in 11; form large herds.



**Clymene dolphin** (*Stenella clymene*)<sup>35,86,115,116,128,136</sup>

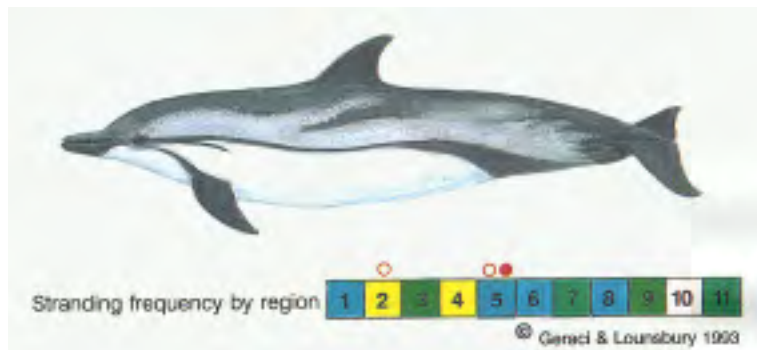
**Range** southern 2; 3; 4.

**Size:** 1.8-2.0 m, 75 kg (adult).

**Distinguishing**

**features:** Similar to spinner, but beak short, caudal peduncle moderately keeled, and coloration pattern more complex, particularly on head (dark band across beak and along top of beak to melon; light band continues over melon to blowhole); black on back not extending to tail stock; white stripe from eye to flipper and darker stripe running forward along flanks from anus. Teeth: 43-58/43-58 each side.

**Habits:** Pelagic in small to large groups.



**Striped dolphin** (*Stenella coeruleoalba*)<sup>32,35,82,86,115,119,121,124,128,136,142,149</sup>

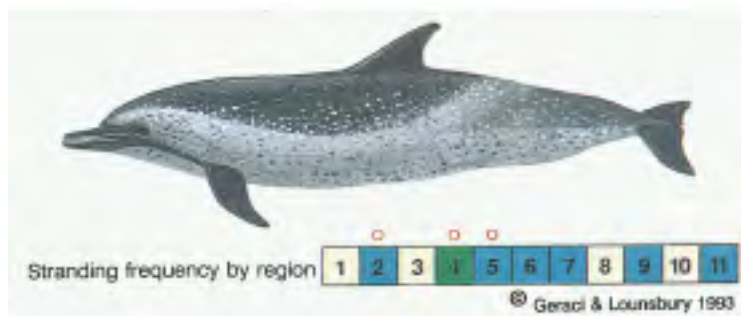
**Range:** 1 (southern, rare); 2; 3; 4; 5; 6; 7; 8; southern 9 (rare); 11.

**Size:** 1.0 m (neonate); 1.7 m (weaning); 2.2-2.6 m, 100-130 kg (adult).

**Distinguishing**

**features:** Body slender; beak long and sharply defined; color pattern distinct with dark back, lighter gray sides, white to gray belly and throat, and black stripes from eye to anus and eye to flipper; tall, curved dorsal fin; fin, flukes and flippers dark. Teeth: 43-50/43-50 each side.

**Habits:** Pelagic; form herds up to several hundred.



**Pantropical spotted dolphin** (*Stenella attenuata*)<sup>32,82,86,90,115,128,142,155</sup>

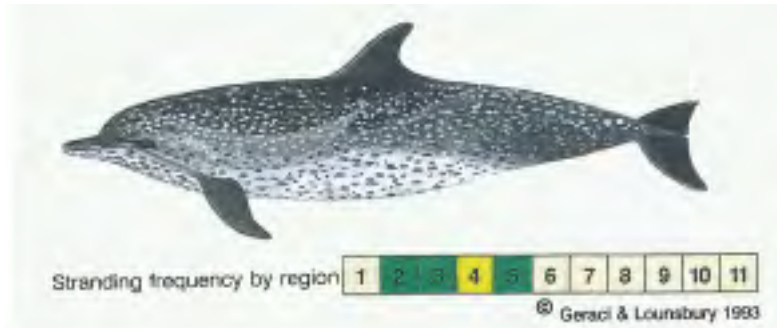
**Range:** 2-3 (uncommon); 4; 5 (uncommon); 6; southern 7; 11.

**Size:** 0.8-1.0 m (neonate); 1.4 m (weaning); 1.6-2.6 m, 90-120 kg (adult).

**Distinguishing**

**features:** Beak long and sharply defined; dorsal fin tall and curved; flippers pointed; young unspotted, dark gray above and light gray below; darker spots appear on belly, enlarging and merging with age; lighter spots appear on dorsal cape and sides; peduncle dark above, light below; degree of spotting and details of flipper and eye stripes highly variable among stocks; approx. 80 vertebrae. Teeth: 35-48/34-47 each side.

**Habits:** Pelagic stocks often occur in schools of more than 1000, coastal populations in smaller herds (<100).



**Atlantic spotted dolphin** (*Stenella frontalis*)<sup>32,35,86,90,115,116,128,136</sup>

**Range:** 2 (southern); 3; 4; 5.

**Size:** 0.8-1.2 m (neonate); 1.4 m (weaning); 2.0-2.3 m, 100-140 kg (adult).

**Distinguishing**

**features:** Similar to above, but heavier-bodied; ventral margin of cape obscured by pale blaze extending along sides from head to below dorsal fin; ventral background white rather than gray; adults become heavily spotted, obscuring background pattern; peduncle not divided into upper dark and lower light halves; flipper stripe demarcated above by narrow light line; approx. 70 vertebrae. Teeth: 32-42/30-40 each side.

**Habits:** Generally pelagic; occur in small groups to schools of several hundred.







*Chapter 7*  
**Cetaceans - Mass Strandings**

7.1. What Is the Attraction to Shore?.....	133
7.2. In the Surf Zone .....	135
7.3. Common Elements.....	136
7.4. Stranding Response .....	138
7.5. First Aid.....	140
7.6. Options .....	140
7.7. Organizing to Collect Specimens and Data .....	142
7.8. Monitoring for Restranding.....	143
References .....	268

A mass stranding can be defined as two or more cetaceans (excluding parent-calf pairs) coming ashore alive at the same time and place. In North America, only a few species of odontocetes typically mass strand in groups of 15 to 100 or more: sperm whales, pilot whales, false killer whales, white-sided dolphins and white-beaked dolphins. Several other species occasionally come ashore in smaller numbers (e.g., pygmy killer whales, pygmy sperm whales, common dolphins, rough-toothed dolphins, and spotted and striped dolphins) (see 6.13). All are gregarious, more or less pelagic forms, or at least less accustomed to inshore waters than such coastal dwellers as bottlenose dolphins or harbor porpoises.

### 7.1. What Is the Attraction to Shore?

Certain pelagic species **follow their prey inshore**. Atlantic white-sided dolphins do this regularly in the Bay of Fundy, and long-finned pilot whales seeking squid and herring venture closer to Cape Cod as winter approaches. The activity is uneventful for the most part, but occasionally a group of animals strikes land. Between 1981 and 1991, there were 10 separate mass strandings of pilot whales within a 20-mile radius on Cape Cod, totalling 476 animals ashore between the months of September and December. This appears to have been a peak decade for pilot whale strandings; only one incident had been recorded from that area in the previous 20 years<sup>14</sup>.

There are too few data to suggest any cyclic activity in stranding patterns. Some investigators have correlated stranding frequency with periods of climatic warming and oceanic current changes that result in lower abundance or a shift in the distribution of prey<sup>53,57,70,73</sup>. Perhaps such shifts bring greater numbers of animals closer to shore, thereby

increasing the likelihood that some will run aground.

While cetaceans do follow prey inshore, there is often no evidence they were feeding at, or just prior to, the time of stranding<sup>22,26,46</sup>. Apart from bringing whales and dolphins into risky territory, it is doubtful inshore foraging behavior alone plays a major role in these events.

Breland and Breland in 1966<sup>5</sup>, and later F.G. Wood<sup>84</sup>, proposed that in times of stress, cetaceans may seek safety on land. This **escape behavior** presumably had evolved in amphibious ancestors and was retained in the primitive subcortical region of the brain. Why such a maladaptive trait should persist after 50 million years of evolution, and be expressed in only a few species (some distantly related), are questions that defy experimentation or explanation.

Other thoughts are as alluring—and just as untestable. The concept of **suicide**—implying some advantage, real or imagined, in taking one's own life—does not hold with what we know of animal (other than human) behavior. Nor does the whimsical notion that whales strand while attempting to **follow the migratory routes** that were laid down by their ancestors.

Sergeant<sup>69</sup> reasoned that mass strandings may be a **means of regulating populations** of social species having low juvenile mortality rates and long life spans. High population density can result in lower birth rates and a reduced period of fertility in social cetaceans<sup>3,16,42</sup>; such density dependent mechanisms likely play a greater role in population control than strandings, which involve a relatively small number of animals.

Klinowska<sup>36,37,38</sup> proposed that cetaceans use the earth's **magnetic field** as both a compass, as some other vertebrates do<sup>25</sup>, and as a map for navigation. Her idea stemmed from a historical review showing that strandings on the British coast tend to occur where the north-south magnetic contours of the ocean floor intersect land perpendicularly (especially in areas of geomagnetic lows or "valleys"), suggesting that the animals might have misinterpreted geomagnetic information. Attempts at similar correlations on other continents are not as clear<sup>2,9,11,34,78</sup>.

Some cetaceans, for example pygmy sperm whales and common dolphins, apparently have single-domain magnetite crystals<sup>2,10,85</sup> in the soft tissue covering the brain, similar to those found in other vertebrates that use the magnetic field for orientation<sup>35</sup>. It remains to be seen whether these simple particles can allow a cetacean to determine north and south, and more importantly, its actual position. The latter, a "magnetic map sense," has not been proven for any species of

animal<sup>25</sup>. The only experimental study with cetaceans, involving two bottlenose dolphins, failed to show any response to changes in a magnetic field or its intensity<sup>2</sup>.

Further study may establish whether cetaceans utilize geomagnetic information<sup>77</sup>, which might bring them inadvertently to certain inshore locations. The results are less likely to explain why they strand.

## 7.2. In the Surf Zone

Many species of cetaceans come close to shore, but few strand. The reason for their presence in shallow water seems less important than the possible factors that occasionally result in large numbers coming ashore.

In some cases, animals are **trapped and grounded** by the outgoing tide. A fortunate few, maybe some with experience<sup>55</sup>, refloat themselves and swim away on the following tide<sup>22,27,45,68,71</sup>; others become stuck<sup>22,75</sup>. Such accidents typically occur in areas with long meandering channels, broad tidal flats, strong or unusual currents, or extreme tidal flow or volume<sup>44,52,68,76</sup>, sometimes in conjunction with spring tides near full or new moon<sup>11,44</sup>. There are several such "whale traps" in North America, including Wellfleet Bay (Cape Cod)<sup>66,69</sup>, Sable Island (Nova Scotia)<sup>18,72</sup>, Lingley Cove (Maine)<sup>22</sup>, and parts of the Gulf of California<sup>23</sup>.

The way a species behaves in **panic** might influence its chances of stranding<sup>24</sup>. Humpback and gray whales reportedly change direction repeatedly during flight<sup>75</sup>, and whether that is related or not, seldom mass strand. In contrast, a frightened sperm whale may steer a straight course for hours<sup>67</sup>, even ramming objects in its path<sup>75</sup> without changing direction. They do mass strand. Coastal whalers use sharp sounds to drive striped dolphins and pilot whales ashore, banking on their tendency to flee in a straight line from the source of alarm<sup>48,70</sup>. This type of response might direct pelagic animals away from danger in open water, but when inshore, they strand on any beach that is in the way. To complicate matters, some species prone to panic, including pilot whales and sperm whales<sup>24</sup>, sometimes swim calmly to shore with no apparent sign of alarm<sup>15,56,64</sup>.

Shortly after the discovery that some odontocetes use echolocation to perceive their environment<sup>33,43</sup>, Dudok Van Heel<sup>12,13</sup> proposed that **distortion of echolocation signals** in shallow water may present an animal with false clues, causing it to beach. The problem would be greatest in areas of gently sloping beaches, a feature common to many (but certainly not all<sup>17,36</sup>) mass strandings, and during storms when water is churned with air and sand. Sonar failure has since been linked

to several other suggested causes of mass strandings, notably environmental factors including thermal gradients<sup>54,61</sup>, complex topography<sup>50</sup> and turbidity<sup>12</sup>, and illnesses such as parasitic neurologic disease<sup>49,62</sup>.

This theory presumes the species in question rely almost exclusively on sonar when in nearshore waters and that this faculty becomes seriously unreliable under certain conditions. It also supposes the sonar of pelagic forms is somehow less sophisticated than that of *Tursiops*, a species that rarely mass strands and the one from which we have largely modeled our understanding of cetacean echolocation<sup>32,59</sup>. Yet experiments with false killer whales indicate an acoustic sense comparable to that of some inshore species and the capacity to alter signals to compensate for background noise<sup>74</sup>—in other words, some capacity to adapt to unusual conditions. The ability of pelagic forms to navigate inshore is not entirely deficient since we know they enter shallow waters much more often than they strand.

To what extent does noise in the surf zone limit the ability of a sonar-equipped cetacean to perceive its environment accurately? What happens to a whale whose hearing is physically impaired by neurologic disease<sup>8,28</sup> or parasites<sup>20,49,62</sup>? Would a whale in trouble use echolocation to the exclusion of other senses? Cetaceans have good underwater and aerial vision<sup>29,51</sup> and would also be expected to employ passive listening<sup>59</sup> to gain environmental cues. When information received from one sense is confusing or conflicts with that received by another, would they not employ an alternate strategy? These are fascinating topics for research that must be squarely addressed before flawed echolocation can be accepted as a basis for strandings.

Limited studies have shown that many individuals within a mass-stranded group bear evidence of **illness** at the time they are examined<sup>80,81,82</sup>. Others show effects of long-standing **disease**, which in some cases may have debilitating effects<sup>4,22</sup>. Whether these conditions might have influenced the group to wander beyond its “safe” range, or encouraged the initial stranding is impossible to determine. Confounding the issue is that chronic disease processes are commonly found in outwardly healthy free-ranging cetaceans, both those that mass strand and those that do not<sup>4,39,79</sup>.

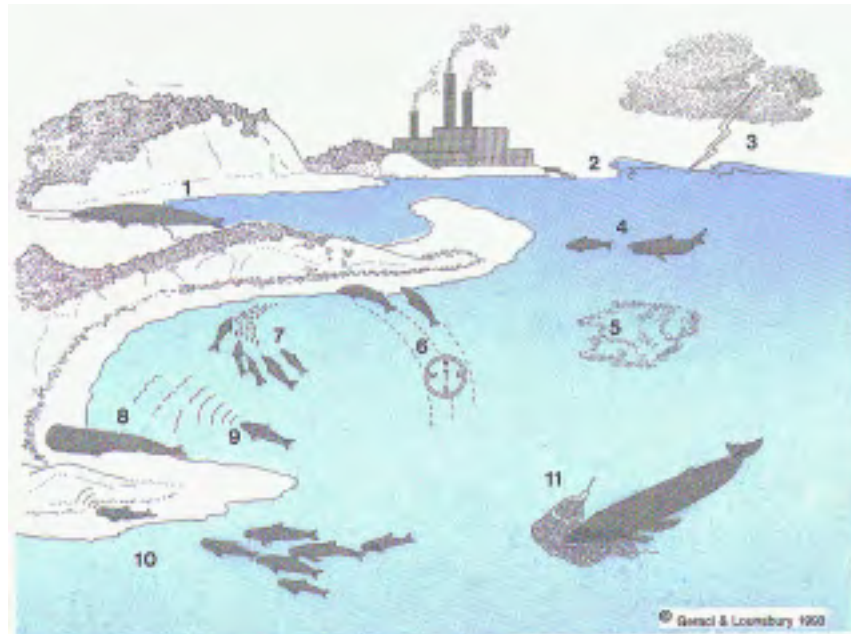
### 7.3. Common Elements

**Cetaceans that mass strand are pelagic forms with a highly evolved social structure.** Certain aspects of behavior that benefit the school in open water seem sometimes deleterious near shore. Norris

and Dohl<sup>55</sup> explained that for these species, *"the school represents the focus of all living activity, and lone animals at sea tend to be severely frightened ... once a large number of a group project common signals about the direction of movement, the factors that determine school structure act to ensure its unified application."*

In other words, once a critical number of animals heads for shore, the rest of the herd is likely to follow. What is the initial stimulus? Observations suggest there may be many situations, such as simple grounding, illness in an individual<sup>60</sup>, electrical storms and other meteorological events<sup>50,65,75</sup>, in which animals are drawn to assist one another<sup>7,41,60</sup> or perhaps led to panic<sup>24,65</sup>.

Social organization alone, however, does not provide all the answers. For example, some strandings are spread over miles of coastline, or occur over a period of days or longer<sup>6,15,30,60</sup>. Only part of a pod may strand while the rest of the animals leave or do not become involved<sup>1,44,63</sup>. Many species that form large schools, such as spinner dolphins and beluga whales, seldom, if ever, mass strand. Clearly, other factors



**Fig. 7.1.** Possible causes of cetacean strandings. 1. Complex topographic and oceanographic conditions. 2. Pollution. 3. Weather conditions. 4. Predators. 5. Natural toxins. 6. Geomagnetic disturbances and errors in navigation while following geomagnetic contours. 7. Following prey inshore. 8. Disease. 9. Disturbance of echolocation in shallow water. 10. Social cohesion. 11. Human-related injuries.

contribute to strandings<sup>19</sup>, but social cohesion is a common thread running through other sometimes nebulous and often untestable theories.

At some point certain strandings seem to be ordained and the animals determined to remain ashore, returning each time they are pushed out to sea<sup>6,15,56</sup>. Refloating the majority of the group may be successful, some suggest, when a vocalizing animal is first returned as a decoy to deeper water<sup>11,15,58,64</sup>. However, rescue is not always that simple.

Our studies with D. St. Aubin at the University of Guelph and G. Early at the New England Aquarium show that the initial stranding can result in physical damage and **physiological stress and shock** (see 6.6), conditions that can affect survival<sup>21</sup>. When released, stranded animals sometimes return, not necessarily because they are compelled to be there, but because one or more of them are now overcome with illness acquired during the last stranding. In other words, subsequent attempts to strand may have little to do with the reason the animal or group came ashore in the first place. **Understanding the debilitating effects of the stranding process, particularly to those animals that restrand, is vital to planning an effective response with realistic goals.**

## 7.4. Stranding Response

Information on cetacean biology and natural history, stranding patterns, basic equipment for handling, supportive care, rehabilitation and euthanasia is presented in Chapter 6. Much of it applies here, but a mass stranding requires a particular approach tailored to the size and number of animals, time ashore, and, of course, the available resources. Small details on the location, weather conditions, orientation of the carcasses—of little value in single strandings—suddenly become important resources for later attempts to determine the cause of the event (see **Table 10.1, Level B data**). See Chapter 2 for information on basic organization and training. The following sections discuss specific needs and actions when responding to a mass stranding.

### Organization

**One person must be in charge of on-site activities.** This Stranding Coordinator can then delegate the responsibilities for various aspects of the operation to several assistants. These may include:

- coordinating with local authorities, the public and media
- procuring supplies and equipment
- training and supervising on-site volunteers

- providing personal amenities for all workers
- looking after the health and safety of the team
- supervising animal support, handling and transport teams
- examining carcasses and collecting tissues
- assembling completed data forms and collected samples
- disposing of carcasses
- debriefing of all involved personnel

**Individuals must remain focused on their assigned tasks.** Volunteers recruited on-site are an essential resource in any mass stranding, and only too willing to help out, particularly during rescue operations. Their work—tasks involving little risk—must be fully supervised (see 3.2, 12.3).

### Early Warnings

Mass strandings may be foreshadowed by **unusual behavior** of animals still in the water<sup>1,31,62,64</sup>. For example, pelagic species appearing uncharacteristically near shore or remaining inshore may be candidates for eventual stranding. The pod may be “milling”—continually circling or moving haphazardly in a tightly packed group—with a member occasionally breaking away and swimming toward the beach. Such behavior may last for only a few minutes or as long as days before any stranding occurs. Early reporting will allow the Operations Center to respond promptly, with greater chance of either preventing the stranding or rescuing the animals that come ashore.

### Averting a Stranding

When a stranding appears imminent, measures can be taken to drive or herd the animals from the surf (see 6.4). Take advantage of the same social instincts that formed the group in the first place. Use noise, nets, people, and boats to herd the animals offshore. Align one or more animals in deeper water facing seaward for others to follow, or hold or tether one offshore as a decoy<sup>11,15,58,64</sup>.

Choosing a decoy is not easy. The “herd leader” might be the ideal candidate, but only the other members of the group know which one that is, and if they followed it to shore once, they may do so again. The animal chosen should be healthy (a sick one may also bring the pod back), alert, some suggest vocal, and able to withstand towing or other procedures. Although an adult might seem appropriate<sup>15,40</sup>, a juvenile may, in fact, elicit a greater response from other pod members.

Position the decoy animal so it vocalizes toward the herd (hopefully beckoning and not discouraging them), and release the decoy once the



group ventures into deeper water. Every animal handled should be identified with a tag (see 6.8), and the details (tag number, time, location) reported to the Operations Center.

## 7.5. First Aid

### Determining Condition

At a mass stranding, **always deal with the live animals first**. Decide quickly whether further strandings can be averted, and determine which animals should be returned to sea, prepared for transportation to a care facility, or euthanized (see Chapter 6). Besides the health of the animals, other factors—environmental conditions and the time and resources available (see 4.3)—will influence how many can be saved. Identify each animal, as well as carcasses, with non-adhesive, highly visible, colored ribbon or tape to direct the teams responsible for treatment and handling (see Chapter 6), sampling (see Chapter 10) and disposal (see Chapter 11).

### Handling and Supportive Care

All live animals should be given supportive care. Organize enough working groups to ensure safe handling of each animal (see 6.6, 6.7, 6.8) without squandering resources. Keep the team's safety in mind; allow only those with suitable apparel and equipment (e.g., wet suits) to operate in harsh surf or weather conditions (see 12.2, 12.3).

Each group should be large enough to tend to an individual animal's needs (see 6.6). When fewer persons are available, **invest in the animals judged to have the greatest prospect of survival, not those near death**, and stick to the basics. Protect against sunburn, douse with water, and monitor respiratory rates and behavior as a head start for the handling team when it arrives. Avoid the urge to do much more. Moving any cetacean requires force. Up to 10 or more people may be needed to carry a young pilot whale; three times that number will be unable to lift an adult.

## 7.6. Options

### Immediate Release

The goal should be the swift release of the largest manageable number that have the best chance of surviving. Carefully select candidates for release, and resist the pressure to "let them all go." As social animals, **the integrity of the group may be as important to survival as the health of the individual**. Without information on what constitutes

the minimum size or critical composition of a viable pod of whales, an arbitrary decision will have to be made when assembling a group for release.

Animals in adequate condition closest to the water-line should be the first returned. Begin by holding them, together with any unbeached animals, in shallow water as a nucleus for rescue. Healthy, strong animals receive priority. Mothers and calves should be moved together. A mother whose calf is dead may be less prone to restrand if the calf is refloated with her and kept from shore. Individuals further up the beach will have to wait for sufficient resources to move them to the water, but, meanwhile, must receive supportive care (see 6.6).

A proven approach is to relocate as many animals as possible to a safe place in shallow water where they can rest and become reoriented<sup>14,47,58,83</sup>. There, assigned team members can tag each one, monitor behavior and vital signs, and obtain blood samples, so that useful correlations can be made for any animal that restrands. After this preliminary operation, the group is released into a clear path of open water (see 6.8). This strategy permits the team to work as a unit instead of dealing with animals independently and haphazardly. It also allows the entire pod to be freed together when surf and tidal conditions are appropriate.

#### **Transport to Care Facility**

Animals that require a period of medical care may be transported to rehabilitation facilities (see 6.9, 6.10). Make a point of selecting two or more individuals for each center. A cetacean recovering from a mass-stranding will undoubtedly benefit by mixing with others of its kind, and any successful release virtually depends on it. Recognize, however, that few facilities can afford this option, have it available, or are in a position to risk the introduction of harmful pathogens to the animals in their permanent collection.

#### **Euthanasia**

Euthanasia (see 6.12), besides its humane purpose, may be the only recourse to prevent hopelessly stranded animals from drawing others to shore. Thus, the survival of the group may rest on the lives of a few. Rescuers are on trial each time they confront a whale that is healthy, but unrescuable, and with a condition that will inevitably deteriorate. Take the time, base the decision on careful examination, including blood-samples if possible, and logistic considerations; explain your reasoning, and proceed confidently.

The time and method of euthanasia should be noted on the data sheet and on the identification tag, to assist other teams that will require this information.

### 7.7. Organizing to Collect Specimens and Data

Data and specimens collected from fresh carcasses may be among the most valuable gathered from the entire event (see Chapter 10). Yet the stranding investigator who ignores the needs of live animals for the sake of “science” will understandably anger team members and observers alike. One approach is to quickly remove some of the freshest carcasses to a location suitable for dissection, while maintaining efforts on the beach to help those that are still alive.

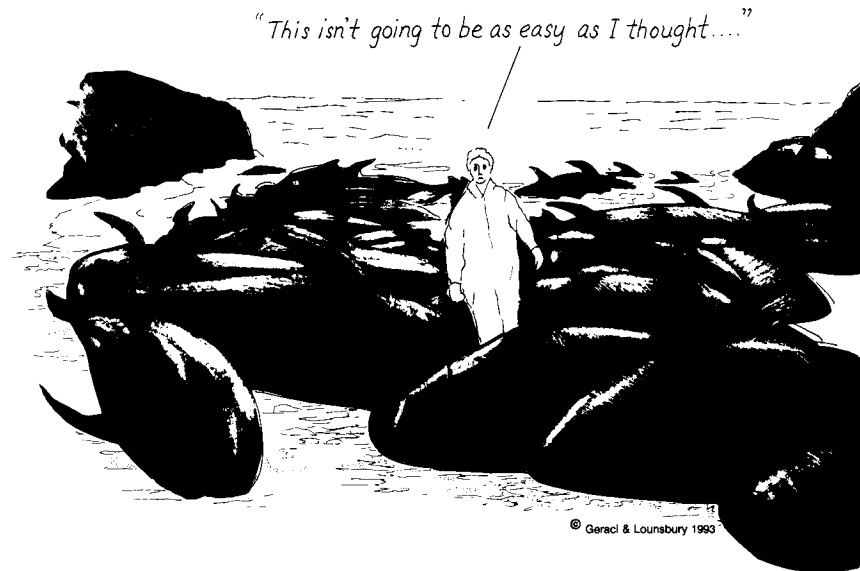
**Valuable time can be lost wandering among carcasses**, puzzling over what to do and whether it has already been done. Examining large numbers of cetaceans requires working teams, each performing a specific task on all carcasses.

**At least three teams are needed:**

- |                      |   |
|----------------------|---|
| 1. Measuring group   | 2 persons to obtain measurements<br>1 person to record data   |
| 2. Sample collection | 1-2 persons with basic anatomical knowledge to collect specimens<br>1 person to label and bag samples |
| 3. Necropsy team     | 1 skilled “pathologist”<br>1 assistant<br>1 to record data  |

**Each group conducts its activity in pre-arranged order**, marks the carcass (alphabetic, numeric or color code) to show its work is completed, and moves on to the next. Specimens for contaminant analyses and microbiology can only be taken from fresh carcasses; this requires close cooperation between the sampling and necropsy teams (see 10.9, 10.10). The disposal group removes only the carcasses that are marked to show all other tasks have been completed. This approach allows the on-site coordinators to assess the progress of the operation at a glance and make adjustments in task assignments to balance activities as necessary.

**The teams’ progress depends on a steady supply of equipment and data sheets.** Pre-packaged measurement, dissection, and sampling kits (see 2.5) will save time at the outset and will need to be replenished as materials are misplaced, broken, or depleted. Individuals



should be assigned the task of collecting completed data sheets and placing them into a (supervised) central file.

Pay attention to hygiene, and provide personal amenities for the team (see 2.6). Require everyone to wear gloves. Arrange for a steady supply of clean water for washing hands and equipment. Have the necessary materials and equipment to clean and sterilize instruments when collecting specimens for microbiology and toxicology (see 10.9, 10.10).

**All collected samples and data must be retrieved, organized, and centrally stored** at the end of each day, under the supervision of a designated person. Specimens for shipping must be properly packaged and documented (see 10.14).

**Emphasize quality (see 10.1). It is better to obtain good samples and perform thorough examinations with accurate documentation on a small number of animals than to do a hasty job on many.**

### 7.8. Monitoring for Restranding

Mass stranded animals returned to sea may restrand, sometimes immediately, but perhaps days or even weeks later<sup>15,30,46,56</sup>. The success rate of these rescue operations is unknown, and can only be determined by long-term monitoring of animals that are released (see 6.8, 6.11). The cost of surveillance can be cut and the effectiveness increased if local individuals or groups (e.g., fishermen, Coast Guard,

sailing clubs) are involved in the effort. Combined with the attention of the media (now certain to be involved), this broadened array of observers will increase the likelihood that sightings or strandings will be reported in time to take action.

*Chapter 8*  
**Manatees**

8.1	Biology .....	145
8.2.	Mortality .....	149
8.3.	Stranding Response .....	151
8.4.	Approach and Handling .....	154
8.5.	First Aid.....	156
8.6.	Transport to Care Facility .....	156
8.7.	Rehabilitation .....	156
8.8.	Release .....	157
8.9.	Euthanasia.....	157
	References .....	273

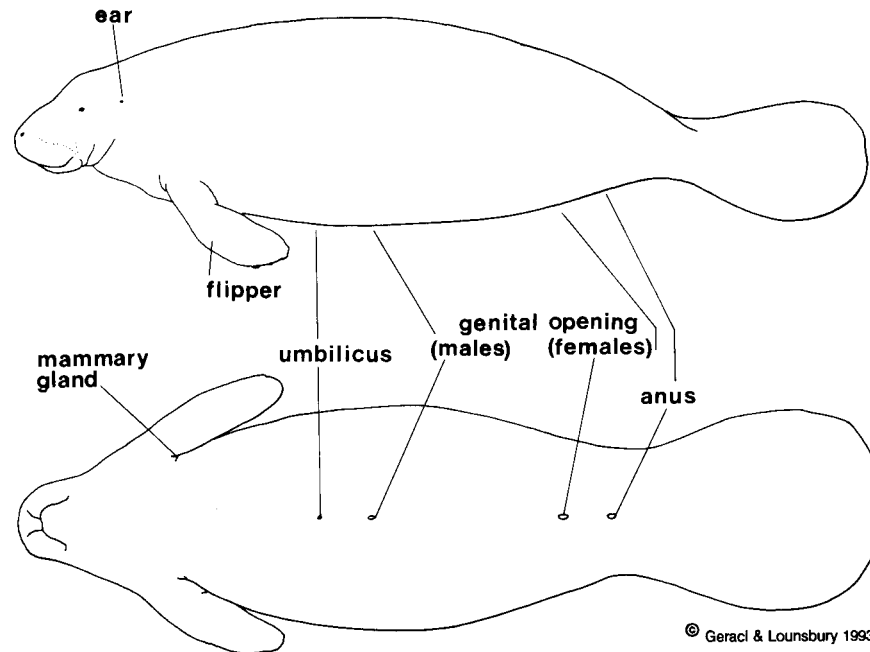
**8.1. Biology**

**Natural History**

The West Indian manatee, *Trichechus manatus*, occupies a unique ecological niche as the only member of the order Sirenia in North American waters. The manatee's low metabolic rate and diet of coastal vegetation restrict it to warm, nearshore waters, shallow protected lagoons and estuaries, and freshwater systems. Its use of the open ocean is generally limited to travel between favored habitats<sup>20</sup>.

Like cetaceans, manatees have streamlined bodies, no external ear pinnae or hind limbs. They have horizontal tail flukes for propulsion<sup>22</sup>, but lack the speed and flexibility of an active predator. Their mobile foreflippers are used to bring food items to their mouths and sometimes even to support the forebody while browsing on shoreline vegetation. The ponderous body severely limits coordinated movement on land.

Manatees breed primarily during the non-winter months in Florida, so most calves are born during warmer weather, after a gestation period of about 12-13 months<sup>21,42</sup>. Cows apparently seek sheltered waters in which to give birth to their single calf<sup>20</sup>. The nursing period is normally 1 to 1.5 years, although the young may begin to graze at 2 to 3 months<sup>20,40</sup>. The interval between births is at least 2 to 3 years<sup>20</sup> and likely 3 to 5 years for some individuals<sup>40</sup>. Both females and males may reach sexual maturity as early as 3 to 4 years of age<sup>21,27</sup>, although they may not breed successfully until they are about 5 to 8 years old<sup>31,33</sup>. The life span is long; the oldest known animal from Florida was estimated to be more than 50 years of age<sup>27</sup>.



**Fig. 8.1.** External morphology of the manatee.

Manatees consume a wide variety of aquatic and semi-aquatic plants. While showing some preference for submerged succulent forms<sup>20,46</sup>, they will feed on floating mats of seaweed, overhanging and emergent vegetation, and even algae, detritus, and salt-marsh grasses when preferred plant species are depleted<sup>20,33,40,47</sup>. To compensate for the low energy content of their diet and low digestive efficiency<sup>9</sup>, manatees must feed for 6 to 8 hours per day<sup>20</sup>, and consequently linger in areas where vegetation is abundant.

**An unusually low metabolic rate and poor insulation limit a manatee's ability to tolerate cool water conditions**<sup>23,51</sup>. Observations in the field<sup>17,52</sup> and laboratory<sup>23</sup> indicate manatees are not well adapted energetically to water temperatures less than about 20°C, a condition occurring in much of upper Florida during the winter. At temperatures approaching 16°C, they may become lethargic and stop eating<sup>17</sup>. Southeastern U.S. waters are therefore the northern limit of the manatee's tropical range.

#### **Distribution**

**The U.S. manatee population centers around peninsular Florida, with some movement into nearby states during spring and summer.** Although migration patterns are more complex and extensive than

previously considered, there appears to be little interchange between the Atlantic and Gulf coasts<sup>45</sup>. Manatees are frequent visitors to Georgia and are sighted with diminishing frequency northward along the Atlantic coast to Cape Hatteras, and rarely as far as Virginia<sup>41</sup>. On the Gulf coast, they occasionally wander as far west as Louisiana<sup>39</sup>. Strays from the declining Mexican population are sometimes sighted in Texas waters<sup>19,39</sup>.

Manatee distribution throughout this range is uneven, with **local concentrations** in areas such as the Indian, Banana, and St. Johns rivers on the Atlantic coast, and the Suwannee, Crystal, and Homosassa rivers (the "Big Bend" region) on the Gulf side; Tampa Bay, the Charlotte



**Fig. 8.2.** Manatee distribution in the United States. Important wintering sites: 1. Jacksonville\*; 2. Blue Spring; 3. Indian River\*; 4. Riviera Beach\*; 5. Fort Lauderdale/Port Everglades\*; 6. coastal Everglades; 7. Ft. Myers\*; 8. Tampa Bay\*; 9. Crystal and Homosassa rivers. \*Indicates artificial warm water refuge. (After O'Shea 1988<sup>34</sup>.)



Harbor-Caloosahatchee River area, and the lower southwest coast to the Everglades are also favored. Manatees are infrequently seen in coastal waters between the southern Big Bend region and Tampa Bay, in Florida Bay, or in the Florida Keys<sup>34</sup>.

From about April to November, manatees range widely between suitable habitats, particularly on the east coast, with its extensive protected waterways<sup>34,45,52</sup>. When traveling from one site to another, manatees swim at speeds of about 3-7 km/hr, although they may reach 18-25 km/hr for short periods when frightened<sup>20</sup>.

**With the onset of cooler weather, most manatees retreat to warm water refuges.** Historically, these refuges included freshwater springs or locations in southernmost parts of Florida where water temperatures remain above 20°C<sup>17,23</sup>. In the past few decades, artificial sources of warm water (20° to 23°C) from power plants and factories have enabled manatees to successfully overwinter in many areas where a natural refuge is unavailable—as far north as Tampa Bay on the west coast, and Jacksonville and even Brunswick, Georgia, on the Atlantic<sup>4,24,45,52</sup>. Continued expansion of the range farther northward is considered unlikely, because potential sites are not warm enough and lack sufficient food in winter<sup>39,41</sup>.

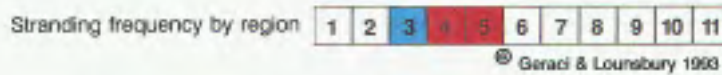
Whereas some manatees spend the entire winter within a few kilometers of a warm water source<sup>20,24</sup>, others may move considerable distances from one site to another. Single bouts of travel documented by satellite telemetry on the Atlantic Coast involve journeys of 200 to 300 km covered in 1 to 2 weeks at rates of up to 50 km per day<sup>44</sup>. Occasional sightings at warm springs of animals with marine algae and barnacles on their bodies suggest they may spend considerable time in saline waters, even during winter<sup>20</sup>. Manatees can apparently maintain their body temperature well enough for short periods of time to allow foraging in colder waters, but return to warmer waters to complete digestion<sup>23</sup>.

**Important wintering areas** along the Gulf coast of Florida include the headwaters of the Crystal and Homosassa rivers<sup>20,39,43</sup>, power plants in Tampa Bay and at Ft. Myers, and inshore waters of the Everglades<sup>24,34</sup>. Along the East Coast, most manatees move southward, though some may congregate at more northerly power plants such as those in Jacksonville and the Indian River<sup>34,45,50,52</sup>. Manatees in the upper St. Johns River winter primarily at Blue Spring, approximately 250 km from the ocean<sup>40</sup>.

The Florida population numbers at least 1,850<sup>1</sup>. This is likely an underestimate, since more than 900 individuals have been identified



photographically by natural markings and scars<sup>8,34</sup>. There have been dramatic increases since the mid-1970s in some monitored northern populations, including those in the Crystal and St. Johns rivers, partly due to strong protective laws, high fecundity, low human-related mortality, some immigration, and abundant food resources resulting from the introduction of exotic aquatic plants<sup>34,39,43</sup>. Increased sightings in Mississippi may be a reflection of the growing population along the northwestern coast of Florida<sup>39,43</sup>. In other parts of Florida, however, habitat degradation and boating activities continue to hinder the recovery of manatee stocks<sup>33,34,49</sup>.



**West Indian Manatee (*Trichechus manatus*)**<sup>18,20,31</sup>

**Range:** 3 (rare); 4; 5 (eastern).

**Size:** 1.1-1.5 m, 30 kg (neonate); 3.5-4.1 m, 1000-1620 kg (max. adult).

**Distinguishing**

**features:** Large bulky body tapering to a spatulate tail; mobile forelimbs with 3-4 nails; body gray to brown, nearly black in newborn; thick, wrinkled skin; prominent facial vibrissae.

**Habits:** Protected shallow coastal waters, estuaries, rivers where vegetation is abundant.

**8.2. Mortality**

**Natural Mortality**

Since 1974, the Sirenia Project (administered by the U.S. Fish and Wildlife Service [USFWS]), the Florida Department of Natural Resources (FDNR) and their various cooperators, have investigated causes of manatee mortality in Florida<sup>2,11,36</sup>. About one-third of the more than 1,900 carcasses examined were considered to have died from natural causes; an equal number could not be classified, primarily because of rapid decomposition in this warm climate<sup>14,36</sup>.

Natural mortality is highest among calves, especially when abandoned or orphaned. Congenital disorders and reproductive complications resulting in abortion and/or stillbirth also contribute to significant losses; the causes of these conditions are unknown<sup>11,15,36,55</sup>.

**Most manatee carcasses are recovered in winter<sup>36</sup>, when extremely cold weather leads to hypothermia<sup>23</sup>.** Losses were high during the severe winters of 1977, 1981, 1984, and 1990<sup>14,18,36</sup>. From 1986 to 1990, deaths attributed to cold stress ranged from about 5 to 23 percent of the total mortality<sup>18</sup>. Common findings included emaciation and absence of food in the gastrointestinal tract<sup>11,36</sup>. Independent juveniles and subadults, with a higher surface to volume ratio and little experience in finding warm-water sources, are at greater risk of cold stress<sup>36</sup>.

At least 37 manatees died between February and April 1982, after inadvertently consuming ascidians contaminated with **brevetoxin** from the "red tide" organism, *Gymnodinium breve*<sup>38</sup>. Affected animals were disoriented and had to be held at the surface to breathe. Many apparently recovered after a brief episode of neurological dysfunction. Those that did not had cerebral hemorrhage or congestion and watery contents of the cecum and/or large intestine; all had ascidians in the digestive tract. Death was probably due to inhibited respiration and inability to surface.

Parasitic infections are common in manatees<sup>7,11</sup> but typically are not debilitating<sup>14</sup>. Microbial disease is uncommon; toxoplasmosis was implicated in one case of meningoencephalitis<sup>13</sup>.

### **Human-Related Mortality**

**Human activities were responsible for the deaths of roughly one-third of the manatees recovered since the mid-1970s<sup>6,34,36</sup>.** Their preference for traveling along protected waterways and boat channels puts these animals at great risk. Collisions with boats and barges are especially common in heavily populated areas along the Atlantic coast and in the St. Johns River, as evidenced by the prevalence of scars on living animals<sup>8,34</sup>. The manatees die either from propeller strikes, usually seen as a series of parallel marks along their back or sides, or from internal injuries caused by impacts that sometimes leave no external wounds<sup>6</sup>.

Drowning or crushing in navigation locks or flood-control gates is limited to a few regions, primarily in southeastern Florida<sup>32</sup>. Although there was some suggestion such accidents might have been decreasing<sup>36</sup>, unpublished information indicates gate-mortality is on the rise again<sup>35</sup>.



Entanglement in fishing gear, entrapment in culverts, ingestion of foreign material such as fish hooks or plastic, and vandalism also take their toll<sup>5,14,36</sup>. Despite regulations, hunting pressure was strong until the 1930s and 1940s, and poaching continues to be a matter of concern, particularly in remote areas of Florida and Georgia<sup>34</sup>.

### 8.3. Stranding Response

#### Jurisdiction

Manatees are protected in U.S. waters by the Marine Mammal Protection Act of 1972 and the U.S. Endangered Species Act of 1973. Florida legislation enacted in 1897 and 1907 prohibited hunting, and the Manatee Sanctuary Act of 1978 recognized the manatee as the official State Marine Mammal and designated the Florida Department of Natural Resources (FDNR) as the agency responsible for its protection. In addition, federal and state agencies began in the mid-1970s to acquire lands, particularly in the Big Bend region, for manatee sanctuaries<sup>49</sup>. The Florida Manatee Recovery Plan, initiated in 1980 and finalized in

1989, mandates specific strategies for the recovery of the species by coordinating all agencies involved in manatee research and management<sup>53</sup>.

The network of federal and state agencies responsible for responding to manatee strandings is much more organized than that which exists for other marine mammals. The program was initiated in 1974 by the USFWS and the University of Miami, and transferred to the FDNR, Marine Mammal Section, in July 1985.

Reports of dead or injured manatees received by the Manatee Hot Line are verified by the Florida Marine Patrol and officers of the Florida Game and Freshwater Fish Commission, who assist in securing the carcasses. Marine Mammal Section personnel are then responsible for carcass retrieval, transport to a designated facility, and necropsy according to detailed guidelines developed by the USFWS Sirenia Project<sup>11</sup>.

With authorization of the USFWS Endangered Species Field Office (Jacksonville), distressed animals may be taken to Sea World of Florida in Orlando or to the Miami Seaquarium for rehabilitation; Lowry Park Zoological Garden in Tampa is also authorized to receive manatees for rehabilitation<sup>49</sup>. Only trained, designated personnel may remove and necropsy carcasses or rescue distressed individuals.

**People not specifically involved with these organizations play an understandably limited role in manatee rescue.** An exception occurred in the 1982 die-off associated with red tide, when FDNR, USFWS, Sea World, and University of Miami personnel enlisted wildlife refuge staff and volunteers to assist with observation, rescue and field necropsies<sup>38</sup>. As yet, FDNR has no specific contingency plan for dealing with a similar large-scale mortality<sup>49</sup>.

### **Evaluating the Event**

Manatees move slowly, often rest motionless at the surface or near the bottom, and may wander into almost any accessible waterway, even in highly populated areas<sup>20,30</sup>. A solitary calf may be left alone temporarily while its mother feeds. Aggressive behavior during mating activities may be misinterpreted as distress<sup>10</sup>. Manatees are also prone to "bloat," a condition that leaves them temporarily unable to submerge. Though it may cause discomfort, the condition normally "passes" (i.e., look for bubbles) in a matter of days and requires no intervention<sup>35</sup>.

**Careful, prolonged observation is necessary to determine whether or not an animal is actually in distress and requires help.** In U.S. waters, only authorized individuals may make this decision.

While some may pull themselves onto shore, most manatees remain in the water when no longer able to function normally. Fresh propeller wounds, monofilament line wrapped around a flipper, weakness, emaciation, inability to submerge, pronounced listing to one side, reluctance to move or suckle, or labored breathing are signs of distress. (Manatees normally breathe once every 1 to 2 minutes when active and traveling and every 5 to 15 minutes when resting on the bottom.) An unaccompanied calf, or an animal far from the normal range or unable to reach warm water during the winter will also need assistance.

During the 1982 red tide in Lee County, some manatees exhibited signs of neurological dysfunction, including disorientation (swimming in tight circles, colliding with pilings, docks and seawalls), inability to submerge or maintain a horizontal position, flexing of the back, listlessness, labored breathing, chewing movements and flaring of the lips, and lack of response to prodding<sup>38</sup>.

Manatees usually strand alone, although a sick or injured female may be accompanied by a calf. They are unlikely to strand as a group because social bonds are unstable<sup>20,48</sup>. While epimeletic (care-giving)

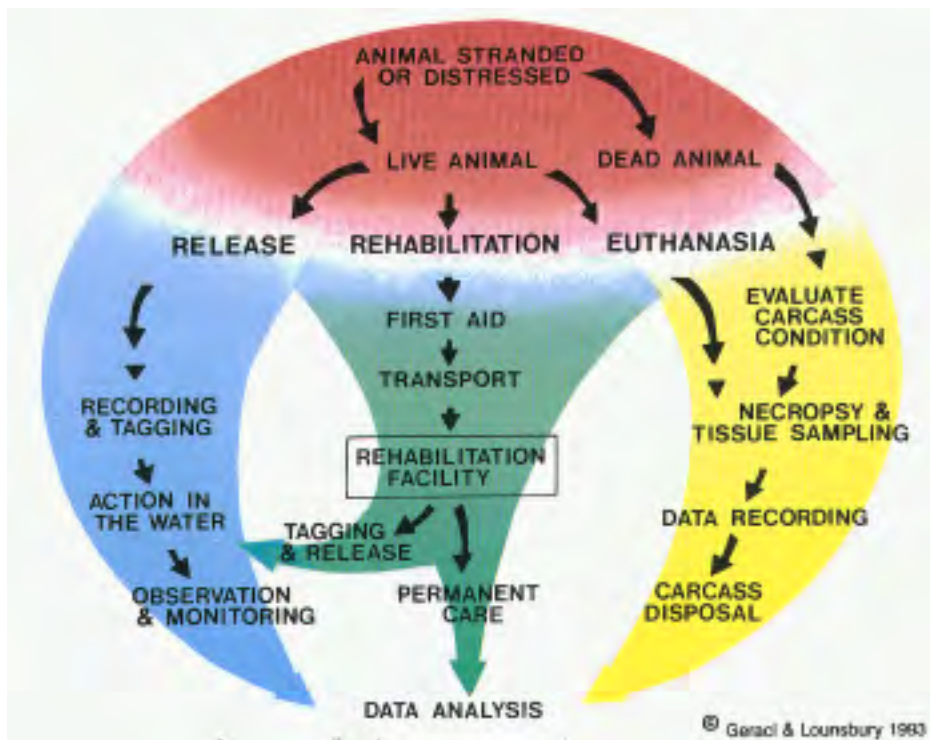


Fig. 8.3. Options for responding to stranded manatees.

behavior has been observed, particularly between cows and dead calves<sup>10</sup>, manatees generally do not appear to help others in distress<sup>20</sup>. Multiple deaths or strandings, not necessarily in the same location, might be anticipated following a spell of extreme cold or a red tide.

**Specific Equipment** (*see also 2.5*)

nets	stretcher
rope	foam pad
buckets	crane or winch
flatbed truck or trailer	heated truck (live animals in winter)

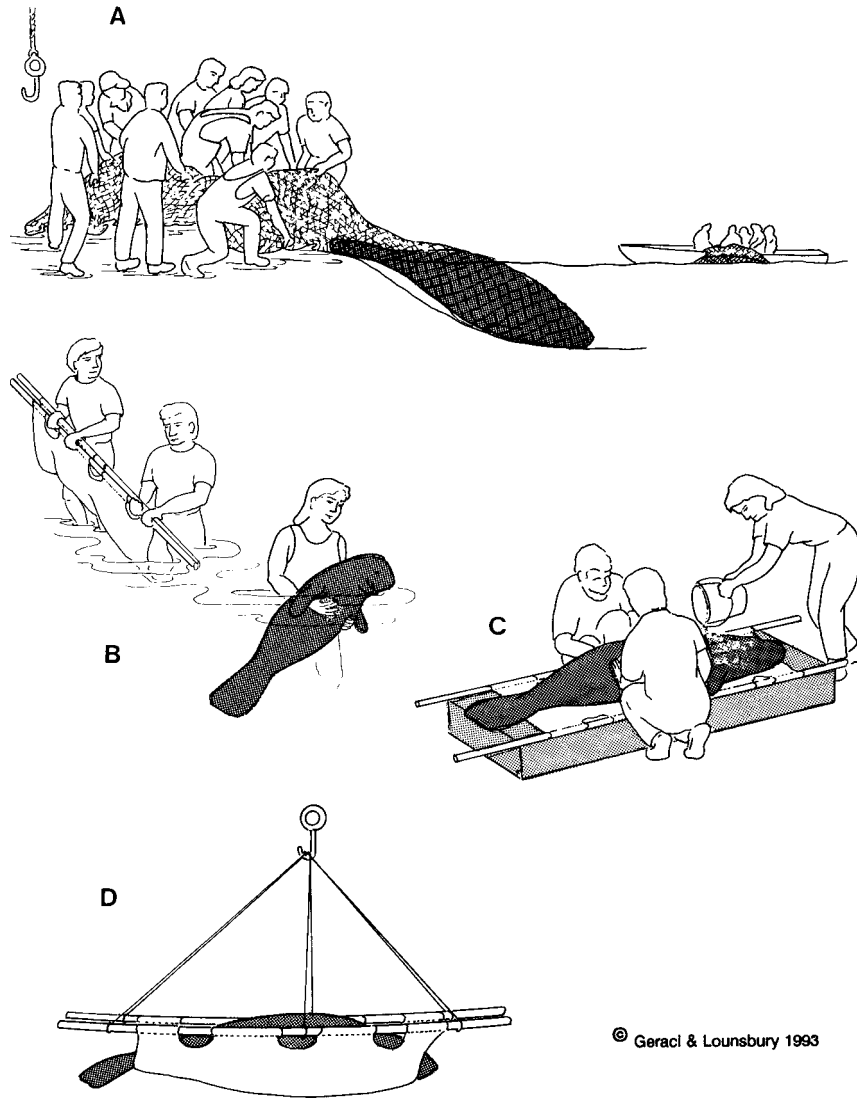
#### **8.4. Approach and Handling**

The effort needed to capture a manatee depends greatly on the animal's condition. Severely debilitated manatees may offer little or no resistance<sup>38</sup>, whereas otherwise healthy individuals can injure themselves or handlers by thrashing about during the rescue operation. Approaching a manatee before all preparations for capture are in place will likely scare the animal away and increase the difficulty of subsequent capture.

One method of capture is to surround the manatee with a net (30 to 35 m long, 4 m deep, with 10 cm stretch mesh) that is gradually drawn toward shore until the animal is in water shallow enough for handlers to physically restrain it. This may require 10-15 people<sup>26,37</sup> for a healthy manatee. **Handlers must use extreme caution to avoid becoming entangled in the net and being pulled into the water if the animal attempts escape.** As soon as the manatee is pulled into shallow water, it is maneuvered onto a padded platform and secured with straps<sup>25,37</sup>. A 3.5 m-long stretcher will also do, provided it is wide enough to accommodate the animal's large girth. The risk of injury to both the manatee and the handlers is especially high when removing the animal from water, and secure restraint is essential.

Once out of the water, manatees generally become calm and may need little restraint. They should be approached quietly, from the front<sup>2</sup>. Covering the eyes and wrapping a small piece of netting over the snout (do not obstruct breathing) helps to calm the animal by giving it the sense that it is still being restrained<sup>10</sup>. Handlers must be cautious of sudden tail thrashings.

Calves can be restrained and supported in the water by a single individual, but they must be placed securely in a stretcher before removal from the water. **One person cannot safely lift a calf**; they are difficult to hold and may be seriously injured if dropped.



**Fig. 8.4.** Techniques for manatee handling and transport. **A.** Netting a manatee and drawing it into shallow water or into a skiff (keep the nostrils above water). **B.** Supporting a neonate in the water by grasping it around the pectoral region from behind; secure in a stretcher before lifting it from the water. **C.** Transport on a foam pad; keep moist. **D.** Moving adults or large juveniles by means of a crane or block and tackle.

© Geraci & Lounsbury 1993



### 8.5. First Aid

Once secured and moved into shallow or protected waters, or onto a sandy beach well above the water line<sup>10</sup>, the animal's condition can be evaluated. Manatees struck by motorboats may have obvious skin lacerations, but just as often there may be little outward evidence of severe internal damage to ribs or lungs. In either case, little can be done on-site to treat such injuries. Open wounds or injured flippers should be protected from further injury during handling and transport.

In the rare event that a manatee has been left stranded on shore by a falling tide, rescuers should provide shade from the sun and keep the animal wet to prevent overheating until it can be examined by qualified medical personnel. Beached manatees have been known to swim away on an incoming tide after several hours of exposure<sup>10</sup>. Cold-stressed manatees should be taken into a warmer environment (i.e., heated truck or warm pool) as soon as possible. Calves are particularly prone to hypothermia.

Some of the manatees presumed to have been affected by the red tide were so disoriented they required assistance to raise their heads above the water to breathe<sup>38</sup>. Under most circumstances, however, **attempts to help an unrestrained manatee are ill-advised and dangerous.**

### 8.6. Transport to Care Facility

Rescued manatees are generally secured in a stretcher and transported by truck on a 15 cm-thick foam pad. Cranes are needed to lift adults. Transport time of up to 3 hours usually presents no problem for an otherwise healthy manatee<sup>37</sup>, but sick or injured animals obviously may be less able to endure the procedure. During transport, the animal should be kept moist and shaded in a 20° to 26°C environment.

Capture stress (myopathy) is not a concern, even after several hours of transport<sup>37</sup>. Nevertheless, it is best to minimize pursuit, vigorous handling, and transportation time. One individual transported for 14 hours survived with no apparent ill-effect beyond a temporary increase in serum levels of muscle enzymes<sup>19</sup>.

### 8.7. Rehabilitation

On arrival at the rehabilitation center, the manatee should receive a thorough physical examination. Blood is drawn using a 25 mL syringe

with an 18- or 20-gauge, 4-cm-long needle on an extension set, from the palmar side of the flipper, between the radius and ulna (see Fig. 10.4); risk of infection is great if the area is not properly cleaned of algae and bacteria<sup>54</sup>. Normal values for blood and urine constituents have been reported<sup>25,28,29,56</sup>. Fecal samples should be examined for signs of dehydration or diarrhea, and cultures taken if possible.

**Manatees recovered during winter should be placed in water 20°C or warmer** to allow them to conserve energy. Critical care measures are particularly effective in dealing with orphaned calves.

In captivity, manatees will soon need to start eating and can be offered a variety of green plants, including lettuce, cabbage, spinach, celery, carrot tops, natural water grasses and water hyacinth<sup>3</sup>. An animal that refuses to eat may first require fluids administered by stomach tube, followed by a gruel consisting of ground lettuce, apples, monkey chow, and water<sup>12</sup>. Artificial formulas have been used successfully to nurse orphaned manatees back to health<sup>54</sup>.

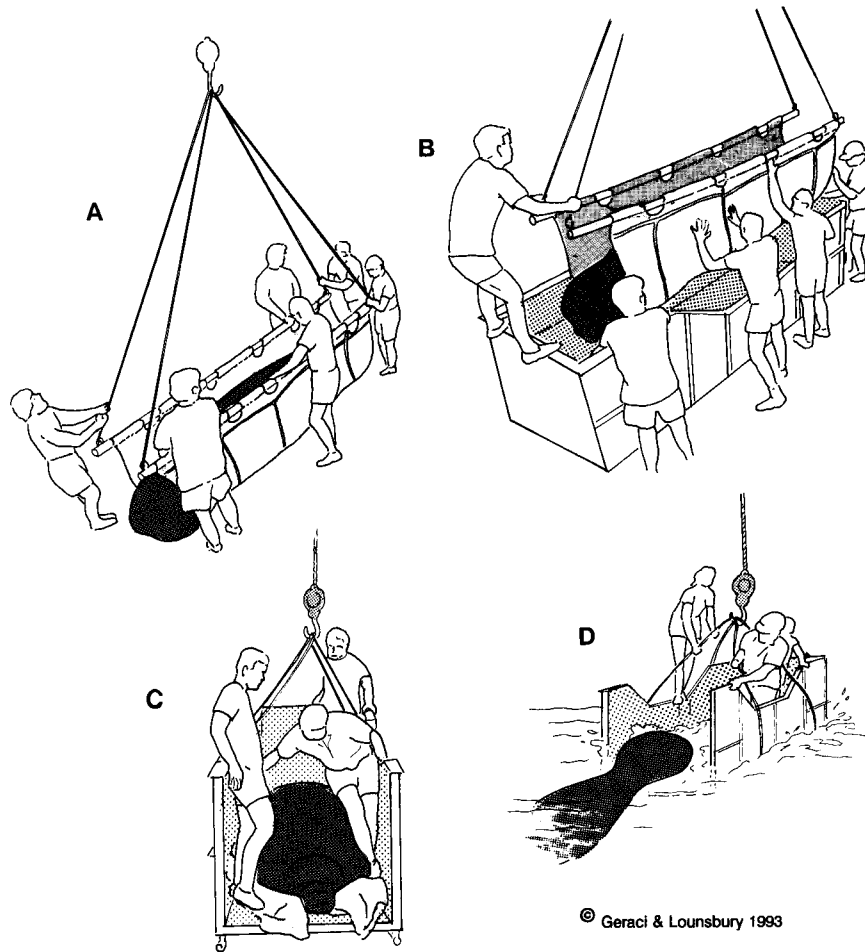
### 8.8. Release

Few manatees are immediately released at the site. These might include trapped or entangled animals with no sign of injury, or, as in the case of manatees affected by red tide toxins<sup>38</sup>, those that regain strength and coordination by the time the rescue team arrives. Of 47 manatees rescued by Sea World from 1974 to 1987, only 3 were released at the site<sup>49</sup>.

The decision to release an animal from a rehabilitation facility is presently made on a case-by-case basis, with authorization from appropriate federal and state agencies. Reynolds and Gluckman<sup>49</sup> suggest that **animals captured as dependent calves should not be released, since they have not learned important behaviors for avoiding boats and finding warm water refuges during cold weather**. Older animals slated for release are freeze-branded and generally fitted with a satellite transmitter to monitor their movements. Rehabilitated manatees monitored by telemetry thus far have readapted well to life in the wild<sup>35</sup>. Manatees are not released from Florida rehabilitation facilities during the winter months.

### 8.9. Euthanasia

Lethal injections of barbiturate have been used effectively.



© Geraci &amp; Lounsbury 1993

**Fig. 8.5.** Techniques for transport and rebase<sup>12</sup>. **A.** Lifting a manatee in a stretcher with a crane. **B.** Lowering a stretcher into a specially designed transport box. **C.** Lowering of transport box into water at the release site. **D.** Release. **NOTE: Be prepared for sudden thrashing at all stages. Keep a firm hold on stretcher, poles, lines, and box.**

*Chapter 9*  
**Sea Otters**

9.1. Biology .....	159
9.2. Mortality .....	163
9.3. Stranding Response .....	164
9.4. Approach and Handling .....	165
9.5. First Aid.....	169
9.6. Transport to Care Facility .....	171
9.7. Rehabilitation .....	171
9.8. Release .....	173
9.9. Euthanasia.....	174
References .....	277

**9.1. Biology**

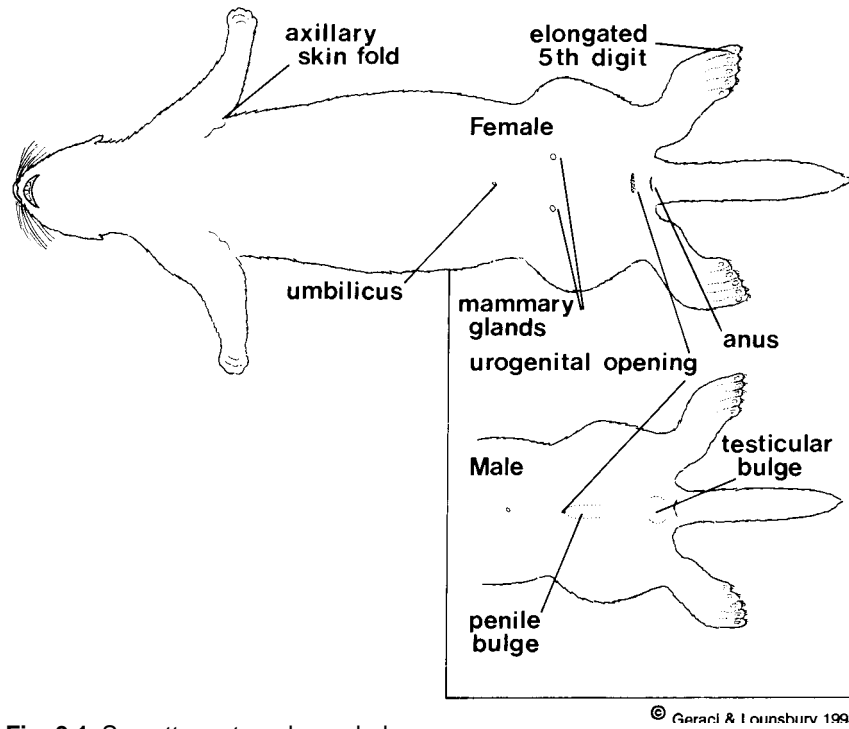
**Natural History**

The sea otter, the only exclusively marine mustelid in the Northern Hemisphere, is the smallest, most recently evolved, and least “marine” marine mammal. Its lack of a blubber layer and absolute dependence on fur for insulation, unique among temperate marine mammals, are arguable evidence of an incomplete adaptation to its environment. Vestiges of a more terrestrial existence may have left the sea otter with a narrow range of environmental tolerance<sup>36</sup>.

**For the sea otter, fur is the key to survival.** The coat, with its extreme density of nearly 100,000 hairs/cm<sup>2</sup>, requires vigorous and frequent grooming to remain clean and to maintain its loft, which is vital for insulation and buoyancy<sup>25</sup>. When the fur is soiled, water penetrates to the skin and the animal becomes chilled.

With a high metabolic rate and low digestive efficiency<sup>4,5</sup>, these animals must consume food equivalent to 20 to 33 percent of their body weight per day. Their needs are even greater in the winter, when activity levels must increase to maintain body heat<sup>5,13</sup>.

Sea otters forage in shallow, nearshore waters often characterized by rocky bottoms and kelp beds<sup>25</sup>. Prey selection varies with individual tastes, foraging ability, and prey abundance and diversity<sup>10</sup>. Under favorable conditions, they select calorie-rich prey such as abalones, sea urchins, crabs, and clams. In habitats where preferred species are depleted, otters must change their eating habits, spend more than half the day searching for food, or move on<sup>9,13,41</sup>. Some long-established populations in Alaska have exhausted the supply of bottom-dwelling



**Fig. 9.1.** Sea otter external morphology.

invertebrates and now feed primarily on fish<sup>10</sup>.

The dexterous forelimbs have well-developed claws and are used for gathering food, feeding, and grooming<sup>17</sup>. Prey items are carried—often in the loose fold of skin in the axilla<sup>25</sup>—to the surface for consumption.

When not diving for food, sea otters spend most of their time at the surface eating, grooming, resting, or traveling from one preferred area to another. Surface-swimming, with the animal on its back, is accomplished by alternate paddling of the hind limbs. They swim underwater by vertical undulations of the rear body, hind limbs and tail<sup>18</sup>.

Sea otters sleep at sea, sometimes joining hundreds of others in favored resting areas<sup>25,34</sup>. Some may haul out to rest, particularly in Alaska, where otters also return to land to give birth, nurse their young, and to conserve energy during severe weather<sup>25,28</sup>. In California, haul-out sites between Monterey Bay and Point Sur are low, algae-covered rocks at least 25 m from shore and away from areas of human disturbance; otters most often haul out during early morning low tides<sup>11</sup>.

Female sea otters reach sexual maturity at 3 to 4 years and males at 5 to 6 years, although neither may breed successfully until they are



**Fig. 9.2.** Sea otter distribution in North America.

older. Pupping occurs throughout the year, with a peak from January to March in California and later in the spring in Alaska. The pregnancy period, including a phase of delayed implantation, is about 6 to 7 months, perhaps varying with environmental conditions. Pups are dependent on their mothers for 5 to 8 months, and the interval between births is about 1 year<sup>21,31,33</sup>.

Male and female sea otters often live apart. In expanding populations and along the California coast, females predominate in the central, more established portions of the range. Breeding males defend territories within the female areas, while other males—juveniles and non-breeding adults—occupy the periphery<sup>12,22,25,41</sup>. These males are typically the first to colonize new areas. Although most otters travel less than a few kilometers daily, juveniles and adult males can cover hundreds of kilometers in a matter of days<sup>12,22,34</sup>.



### Distinguishing

**features:** Body elongated and heavy; pelage dense, light buff to brown to nearly black; head and shoulders often lighter, sometimes almost white in adults; newborn with light brown woolly coat, darkening by about 3 months of age; canines blunt, molars and premolars rounded and flattened; fully webbed hind feet, 5th digit the longest. Males distinguishable from females by the penile and testicular bulge and more muscular head and neck; females have abdominal mammae and are the only ones known to carry pups. Adult dental formula: I3/2, C1/1, P3/3, M1/2.

**Habits:** Coastal, often associated with kelp beds and rocky bottom habitats; generally remain at surface when not diving for food.

### Distribution

Sea otters once ranged throughout much of the coastal North Pacific but were reduced to remnant colonies by the early 1900s. Through protective measures instituted in 1911, they began a dramatic recovery<sup>25</sup>, particularly those from the Aleutian Islands eastward to Prince William Sound (Alaska). In this part of the range, many local populations are thought to have reached “carrying capacity”—the maximum number that the environment can support<sup>33,34</sup>. The Alaskan population is estimated to be about 150,000<sup>19</sup>.

The California population of about 2,000 animals occupies a 380-km (240-mile) stretch of coastline between Point Año Nuevo and Point Conception, with greatest densities at the northern and southern limits<sup>21</sup>. In the 1960s and 1970s, sea otters were successfully translocated to southeastern Alaska, British Columbia, and Washington<sup>23,24,26,34,39,40</sup>. Attempts to establish a colony on San Nicolas Island have not been

encouraging; by the fall of 1991, only 14 of the 135 otters released on the island since 1987 remained. However, 12 pups have been born there during that time<sup>21,32</sup>. It is worth noting that initial growth of populations translocated to other areas has also been slow<sup>23,24,26</sup>.

## 9.2. Mortality

### Natural Mortality

Sea otter mortality varies regionally and seasonally. Throughout their range, severe winter storms bring otters ashore suffering from trauma, exposure, and emaciation resulting from increased difficulties in foraging<sup>3,25,28,29</sup>. Heavy ice conditions and limited food resources also contribute to mortality<sup>25,34,41</sup>. Dependent pups, juveniles (because of inexperience and an incomplete set of permanent teeth), and old animals with worn teeth are the most common victims<sup>25</sup>. In California, a late summer peak in juvenile strandings coincides with weaning<sup>3</sup>.

Other causes of natural mortality include infections following injuries received during mating or fighting, complications during birth, intestinal parasitism, and disease, including enteritis associated with prolonged stress<sup>25,29,36</sup>. Shellfish poisoning was suspected in a 1987 die-off in Alaska<sup>8</sup>. Predators also take their toll. In Alaska, eagles sometimes prey on pups, and coyotes kill juveniles that haul out to conserve energy when food is scarce<sup>28</sup>; in California, sharks are the more serious threat<sup>33</sup>.

### Human-Related Mortality

Sea otters in Alaska are occasionally shot as quarry by native hunters or, as in California, for intruding on fisheries activities. Some, especially inexperienced juveniles, are hit by boats or become entangled in fishing nets and marine debris<sup>28,34,35,40,41</sup>.

**Oil spills are a particularly serious threat to sea otters.** The 1989 *Exxon Valdez* spill in Prince William Sound claimed more than 1,000 animals. Fresh, volatile oil kills by damaging the respiratory, digestive and urinary systems<sup>22,42,44</sup>. Though less acutely harmful, oil that remains at the surface presents an enduring hazard. Fouling robs the fur of natural oils that normally hold the loft that provides insulation. Metabolic rate increases to counter the elevated heat loss. The victim becomes so intent on restoring the pelt that it forgoes feeding and resting, spending its time grooming instead. Sapped of energy, with no stores to draw from, the otter eventually dies of stress and shock<sup>5,14</sup>.





### 9.3. Stranding Response

#### Jurisdiction

Sea otters were first protected in 1911 under the International Fur Seal Treaty and then by legislation introduced by the state of California in 1913. The Marine Mammal Protection Act (1972) placed them under the jurisdiction of the U.S. Fish and Wildlife Service (USFWS). California sea otters are further protected under the Endangered Species Act of 1973 and are managed by federal and state agencies. In British Columbia, sea otters are protected by the Federal Fisheries Act and the B.C. Wildlife Act and Regulations.

The California Department of Fish and Game (CDFG) and the USFWS conduct programs to recover carcasses in California, relying on public reporting as well as surveys of certain isolated beaches<sup>3,15,20</sup>. Because most carcasses are washed ashore and may lie undiscovered for days, investigations into the cause of death are not often successful<sup>3,15,29,41</sup>.

Along U.S. coastlines, the occurrence and location of sea otter carcasses must be reported to either federal (USFWS) or state (Alaska, California, or Washington DFG) authorities.

### Evaluating the Event

Unless the need for intervention is obvious, sea otters should be carefully observed for at least 15 to 20 minutes before any action is taken<sup>2</sup>. Hauling out is a normal behavior in some regions, and a sea otter on shore may simply be resting, about to give birth, or nursing a pup. While healthy animals will typically avoid humans, they may tolerate close approach by a boat. A female otter may dive for food, leaving her pup vocalizing plaintively at the surface. **Most situations of this kind do not warrant action.**

Some behaviors signal distress. An otter on shore that appears lethargic, agitated, reluctant to enter the water, or makes no attempt to evade capture may need help<sup>16</sup>. Excessive or exaggerated grooming, due perhaps to soiling of the fur, may lead to damage to the skin, ears, or eyes<sup>44</sup>. Oil-contaminated otters may raise the upper part of the body out of the water and shake vigorously, although this behavior is not necessarily restricted to fouled animals<sup>16</sup>.

More obvious indications of distress are emaciation, wounds, labored breathing, violent shivering, matted fur, and restricted mobility. If the fur retains a slick wet appearance after more than 10 seconds at the surface, the otter may be contaminated and should be considered a candidate for capture<sup>2</sup>.

Sea otters sometimes wander beyond their normal range into unsuitable habitats<sup>25</sup>, but they are unlikely to remain in areas with inadequate food resources. An animal lingering in an unusual location may require assistance, especially if it shows signs of distress or is endangered by local conditions (e.g., fishing activities, pollution).

**Sea otters normally strand individually, but dozens or hundreds of animals may come ashore** following severe storms, disasters such as oil-spills<sup>6,14</sup>, or outbreaks of suspected biotoxin poisoning<sup>8</sup>.

#### Specific Equipment (see also 2.5)

dip nets	stuff bags
tangle nets (modified gill nets)	ice
transport cages	

## 9.4. Approach and Handling

### Words of Caution

**Sea otters are sensitive to and can die from the stress associated**

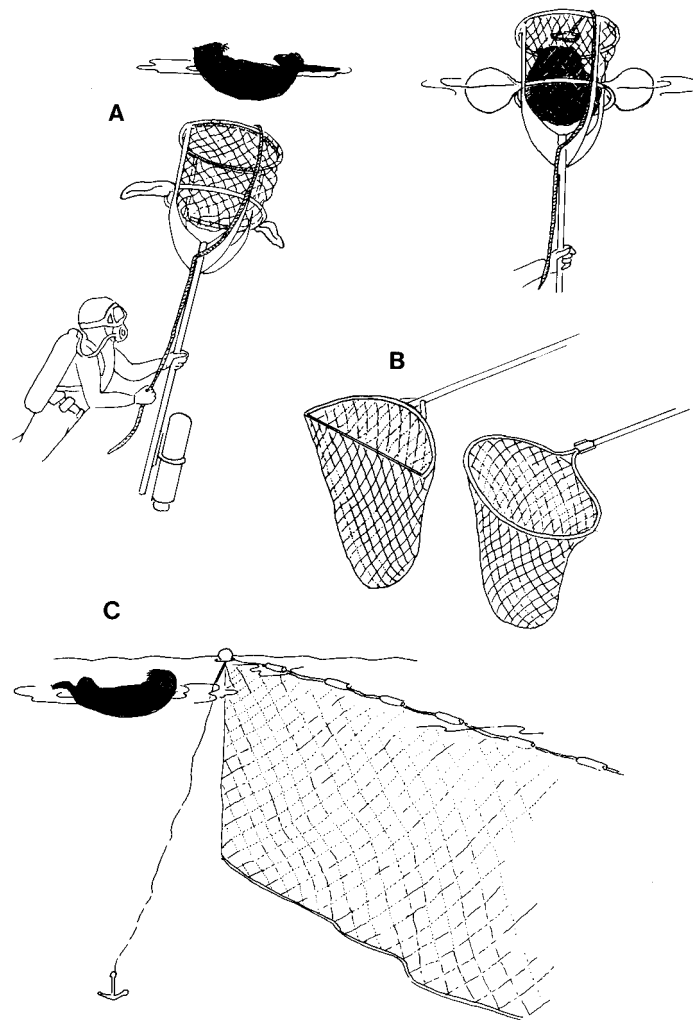
**with capture, transport, and rehabilitation**<sup>25,30,36</sup>. The need for assistance must be carefully evaluated before subjecting these animals to unnecessary disturbance. Otters alert and active enough to avoid capture are better left alone. Chasing mothers with young may result in abandonment or drowning of the pup<sup>16</sup>. Always keep pets and other domestic animals away from the area.

Appearances—winsome face and mannerisms—are definitely deceiving. **Sea otters have an aggressive temperament**, dexterous forelimbs, forepaws armed with sharp claws, flexible bodies with loose skin, and strong jaws with teeth adapted for crushing. They should be approached quietly, with minimum disturbance<sup>42</sup>, and handled cautiously once captured. Heavy leather gloves with long cuffs should be worn to minimize serious scratch and bite injuries, bearing in mind that a sea otter can still crush a finger through a glove<sup>2,38,42</sup>. Otters are so flexible, they seem able to turn around inside their loose skin; for that reason one should never be grabbed by the tail or nape of the neck<sup>2</sup>.

### Techniques

**Sea otters can be captured safely only by trained personnel.** The most successful methods use dip nets, modified gill nets (tangle nets),





**Fig. 9.4.** Techniques for capture of sea otters. **A.** Wilson trap (modified from Wild and Ames 1974). **B.** Dip nets. **C.** Modified gill net (redrawn from Hill *et al.*, 1990).

or specially designed diver-held “Wilson” traps<sup>1,16,48</sup> (Fig. 9.4). Choice of method depends on the experience of the handling team, the sea state, condition of the animal and the type of habitat.

Dip nets can be used from skiffs and are effective for capturing selected individuals, particularly juveniles and lethargic adults. Older, healthy animals tend to dive to avoid capture<sup>16,48</sup>. Dip nets cannot be used in rough seas or in kelp beds.

Gill nets (30 m long x 3-6 m deep) made of 20- to 23-cm stretch mesh net are modified by removing or reducing the weighted bottom line so entangled animals will stay at the surface<sup>16,48</sup>. These nets work well for active animals too elusive to be taken with dip nets<sup>16</sup>. Gill nets are, however, non-selective and require constant monitoring to avoid injuring trapped animals. Gill nets cannot be used in kelp beds, shallow rocky areas, or in rough seas.

Diver-held devices designed by CDFG biologist K.C. Wilson have been used successfully in California to catch animals at the surface and keep them floating there, safe but secure, until a boat arrives<sup>1,41</sup>. These traps can be used in kelp beds<sup>32</sup> and have the advantage of surprise, thus minimizing the stress associated with chasing.

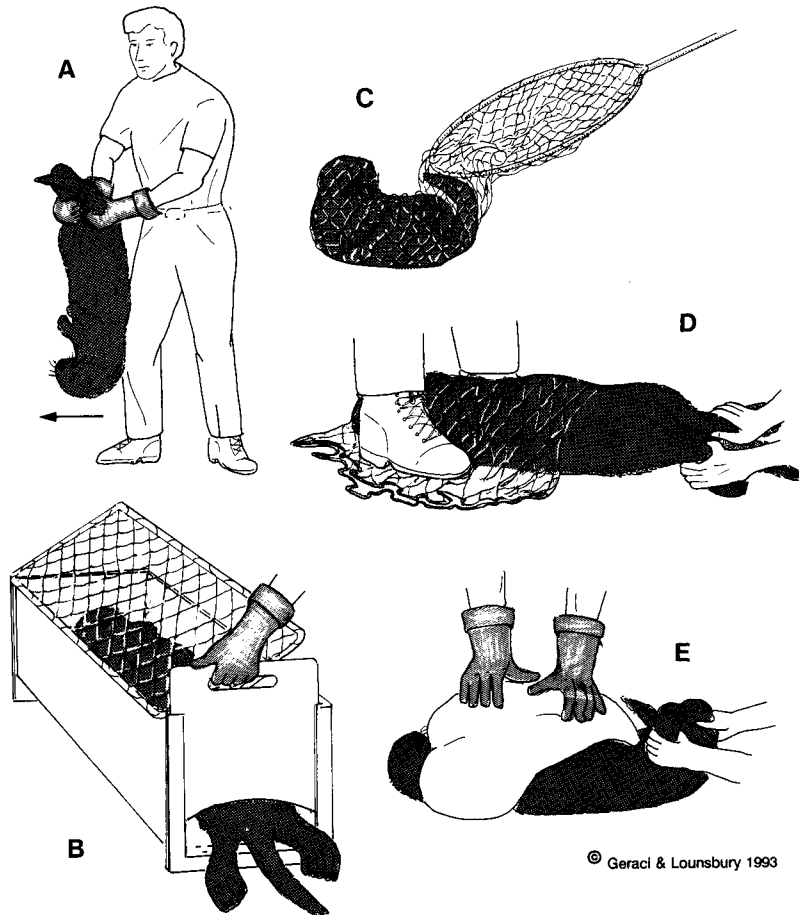
Sea otters should be approached quietly, and from downwind if possible because of their acute sense of smell<sup>25</sup>. On land, dip nets are used to capture sleeping otters or weakened juvenile or old animals driven ashore during storms<sup>25</sup>. Healthy adults are more difficult to catch, and mothers with pups tend to be more alert and to come ashore in less accessible places<sup>25</sup>. Distressed otters may make little or no attempt to escape and can be caught with dip nets, tangle nets, or if weak, picked up by hand and placed into cages<sup>16</sup>.

Direct communication between the capture crews, transport vehicles, and the rehabilitation center is essential, particularly in a large-scale rescue<sup>16,43</sup>. A specialist should be present on every capture boat to assess each sea otter's condition and provide immediate supportive care<sup>43</sup>.

Captured otters should immediately be placed in a box or transport cage<sup>32</sup>. Lining the box with a net bag will allow for easier removal and transfer to a cage, but can present problems if the otter becomes entangled. Unless judged to be hypothermic (see 9.5), rescued animals should be transported on a bed of ice shavings or cubes.

Smaller and less aggressive animals can be picked up by the hind legs, held upside down with their backs to the handler (keeping the forepaws and head as far away as possible), and placed in a cage or restraint device. Dip nets, blankets, throw nets, or stuff bags will be needed for handling larger or more aggressive otters<sup>42</sup> (Fig. 9.5).

The degree to which an otter must be restrained depends on its health and the objectives of the mission. Complete restraint is recommended for most physical examination and sampling procedures. This can be accomplished using transport cages or specially designed restraint cages, devices in conjunction with a stuff bag, or by chemical sedation<sup>42,45</sup>. **Avoid excessive or prolonged restraint.**

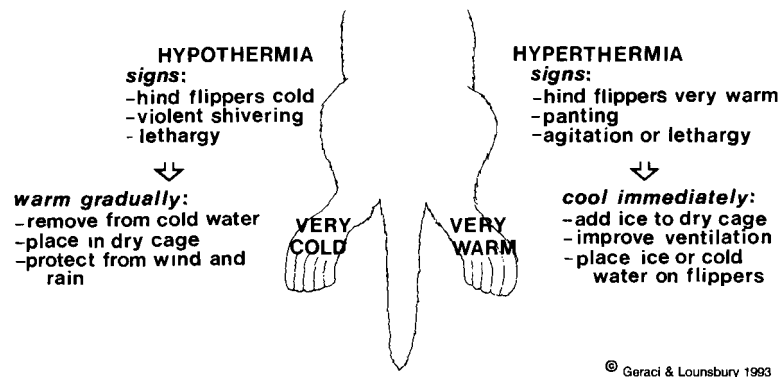


**Fig. 9.5.** Sea otter handling and restraint. **A.** Holding hind limbs, with animal facing away from handler. **B.** Restraint device. Restraint employing **(C)** dip net, **(D)** tangle net, **(E)** stuff bag.

## 9.5. First Aid

### Determining Condition

Sea otters should be evaluated for evidence of respiratory distress (normal rate 17 to 20 breaths/minute), dehydration, wounds, soiling of the pelage, emaciation, and diarrhea. Normal heart rate is 144 to 159 beats/minute. As a rough indication of body temperature, the hind flippers should be cool to the touch. Very warm or very cold flippers, violent shivering or panting signify thermoregulatory difficulties<sup>42,44</sup> (Fig. 9.6).



**Fig. 9.6.** First aid measures for stranded sea otters: the signs and treatment of hypothermia and hyperthermia.

The animal's general condition may be classified as<sup>42</sup>:

1. **alert and normal**
2. **depressed** (inactive and unresponsive to environmental stimuli)
3. **semicomatose** (responding only to painful stimuli)
4. **comatose** (retaining some simple reflexes, but otherwise unresponsive)

The course of treatment may depend on the age of the animal. A rough guide according to weight<sup>27</sup> is:

1. **small pup** (less than 3 months, 1.0-4.5 kg)
2. **large pup** (3 months-1 year, 4.5-13.5 kg)
3. **subadult to adult** (>13.5 kg)

Consider in your estimate that an otter can lose as much as 25 to 33 percent of its body weight (mostly from muscle) rapidly when under prolonged stress<sup>41</sup>.

### **Supportive Care**

As soon as possible after rescue, stabilize the otter's body temperature, treat shock and dehydration, and offer food and water<sup>42,43,44</sup>. Signs of dangerous **hypothermia** (body temperature less than 36°C) include lethargy, lack of reaction to handling, cold hind flippers, and violent shivering (mild shivering is not a reliable sign)<sup>38,42,44</sup>. Place the animal in a dry cage protected from draft, and warm it gradually with a pet dryer or heat lamp, or in severe cases, place the hind flippers in warm water. Oral glucose therapy may be necessary until the otter is conscious enough to accept food<sup>38</sup>.

**Hyperthermia** (>39.5°C) is manifested by lethargy and warm, often flared, hind flippers. The condition may arise during captivity or transport when an active or sedated animal is confined without access to ice or water. Some oiled otters become hyperthermic through excessive grooming and in response to handling<sup>16,44</sup>. Hyperthermia may be relieved by using cold or iced water on the hind flippers, or as a bath for immersing the animal<sup>38,44</sup>.

## 9.6. Transport to Care Facility

Sea otters may be transported in uncovered plastic kennel cages with a rack placed on the bottom to keep the animal from becoming soled<sup>16,32</sup>. Cages of wood, fiberglass or metal with netting side panels and a raised rack in the bottom are also suitable<sup>46</sup>. The wire mesh door on kennel cages should be replaced with netting to avoid injuries from chewing during longer transports<sup>46</sup>. **Provide ice as a source of water, particularly during warm weather**, and drain accumulated water from the cage<sup>2</sup>. During extended transports, offer food (e.g., shellfish meats) approximately every 2 hours<sup>43</sup>.

Transport otters quickly (less than 3 hours transit time) within 6 hours of rescue<sup>16</sup>. Transport vehicles should be well ventilated and adequately lit so animals can be continually monitored. Ice or heaters must be readily available to allow for prompt treatment of hyper- or hypothermia<sup>46</sup>. Helicopters have proven useful for moving large numbers of animals rapidly<sup>43</sup>.

Before transport or immediately upon arrival at the rehabilitation center, all animals should be tagged on a flipper for identification<sup>2,38</sup>.

## 9.7. Rehabilitation

At the care facility, the condition of the animal should be reevaluated and a blood sample taken. The results will dictate whether to treat for **hypo- or hyperthermia, hypoglycemia, dehydration, diarrhea, or shock**.

### General Considerations

Facilities for rehabilitating otters must include cleaning areas, dry cages, cages with pools, and floating pens for holding prior to release—all with adequate water flow and ventilation<sup>38,43</sup>. Enclosures should be designed to avoid injury from chewing. Secure the area from domestic pets<sup>45</sup>.

Sea otters are preferably kept in groups of two or more, although males and females should be separated and mature males housed



individually. Females should be isolated with their pups until the pups are at least one month old<sup>38</sup>.

Holding pools should be filled with sea water (fresh water may be used temporarily) to a depth of at least 0.6 m to allow for adequate grooming<sup>38</sup>. Maintain water temperature at 7° to 15°C and **do not use chlorine**<sup>42</sup>. Recovering animals must be provided with adequate haul-out space. Sea otters kept in dry pens for more than one or two days may develop pressure sores; this can be minimized by constructing the pen floor of smooth plastic perforated with 2.5-cm diameter holes<sup>38,45</sup>.

Juvenile and adult sea otters thrive on a mixed diet of shellfish and fish consumed at a rate equivalent to 20 to 30 percent body wt/day, but they can consume more than the equivalent of 50 percent of their body wt/day when unable to maintain body temperature. Animals with serious health problems should be offered food hourly, while others may be fed every 4 hours<sup>38</sup>. Avoid overfeeding healthy otters<sup>2</sup>. Chips and chunks of ice are a crafty means of providing water to an animal most likely to tip over a bucket.

Pups tolerate considerable handling and, after the *Exxon Valdez* spill, were generally found to do well if they survived the first two weeks in captivity<sup>38</sup>. They need constant attention until at least three months of age, including regular temperature checks, formula-feeding, and careful washing, drying, and grooming<sup>38,42</sup>. Rehabilitation of an orphaned pup may require 6 to 9 months, including a period of weaning the otter from its attachment to humans<sup>42</sup>.

**Reduce stress to captive sea otters as much as possible** by maintaining a clean, quiet environment, secure from domestic pets, and by minimizing handling. Harmful behaviors can be curbed by providing ready access to water for swimming and grooming, and to food, ice, and canine chew-toys<sup>38</sup>. Preoccupation with chewing may simply indicate the otter is hungry<sup>27</sup>.

#### **Caring for Oiled Otters**

Oil that fouls an otter may also irritate the eyes and cause sinusitis, emphysema, anemia, and systemic toxicity. Therapy may require treatment for these conditions as well as measures to restore the insulative properties of the pelage.

Heavily oiled animals should be cleaned immediately to reduce ingestion and absorption of oil<sup>44</sup>. Cleaning those that are lightly oiled may be delayed for 12 to 24 hours to allow for recovery from the stress of capture and transportation and to provide food and fluid therapy.

Before cleaning can begin, the otter must be sedated—assuming it is healthy enough to withstand the procedure. Sedation allows safe handling without excessive stress to the animal and permits monitoring of rectal temperature. Oiled fur must be washed (Dawn® dishwashing detergent [Proctor and Gamble] is recommended), rinsed and dried, and finally freed of all traces of detergent<sup>7,42,45</sup>.

Washing removes natural oils from the fur and greatly increases thermal conductance<sup>7</sup>. Placing the otters in seawater pools for brief intervals encourages grooming and restoration of the water repellency, though it will be necessary to remove them for drying. The animals will gradually tolerate longer periods in the water without signs of chilling; after 7 to 10 days the fur should regain its insulative value<sup>44</sup>.

## 9.8. Release

Animals with health problems that might limit their chances of survival in the wild should not be released and must either be adopted into a captive colony or euthanized.

### Immediate Release

An animal that is “rescued” but appears healthy and alert and exhibits normal behavior should be released as quickly as possible. Release should take place at the “home” site, unless hazards there (e.g., fishing, boating activities, pollution) warrant selection of an alternate location. Dependent pups should not be returned to the water unless the mother is present. Animals captured far outside the normal range are not candidates for immediate release. Whether released from a boat or on a beach, otters should always be allowed to enter the water of their own accord<sup>47</sup>.

### Release Following Recovery

As soon as an animal is judged fit, it should be released, either directly into the wild or after a period of acclimation in floating pens where visual and physical contact with humans is minimal<sup>43</sup>.

Tagging is the only reliable method of monitoring released sea otters. Intra-peritoneally implanted transmitters have allowed tracking for up to 3 years with few problems<sup>42</sup>. Transponder chips may also be implanted for permanent identification<sup>37</sup>. Radio transmitters attached to flippers have allowed brief tracking, but this method is not recommended: the transmitter is too easily removed by the otter and may damage the flipper<sup>42</sup>.

### **9.9. Euthanasia**

The U.S. Fish and Wildlife Service has authorized sea otter rehabilitation centers to euthanize terminally ill animals<sup>16</sup>. This is achieved by injecting a lethal substance into the distal third of the femoral vein, or into the heart or jugular vein<sup>42</sup>.

*Chapter 10*  
**Specimen and Data Collection**

10.1.	General Considerations.....	175
10.2.	Sampling Live Animals .....	176
10.3.	Evaluating a Carcass.....	182
10.4.	Protocols - General Considerations .....	185
10.5.	Examining the Carcass .....	187
10.6.	Blood Studies .....	200
10.7.	Morphometrics .....	201
10.8.	Life History .....	202
10.9.	Contaminants and Biotoxins .....	205
10.10.	Microbiology .....	211
10.11.	Gross and Histopathology.....	216
10.12.	Parasitology .....	218
10.13.	Samples for Skeletal Preparations.....	223
10.14.	Packaging and Shipping.....	225
	References .....	280

**10.1. General Considerations**

**The Quality of information**

The quality of information obtained from stranded animals depends on a number of factors, including:

- condition and location of the specimens
- size, skills, organization, interests and morale of the team
- adherence to clear, detailed protocols
- availability of equipment and supplies
- number of animals to be examined
- amount of time available
- care maintained in packaging and labeling samples
- care in shipping and storing samples

**Documenting Data**

**Information has scientific value only when carefully documented.** Persons recording data need reasonable language skills, legible writing, and familiarity with appropriate terminology. The use of standardized data sheets or a bound log book made of good quality paper (waterproof is ideal) is recommended. Notes should be taken with waterproof ink or soft pencil. Depending on conditions, data collection may be basic (**Level A**), intermediate (**Level B**), or detailed (**Level C**) (Table 10.1).



Beyond written observations, **photographic** and **video-taped records** may bring to life such details as color pattern, distinctive markings, scars or injuries, and the pattern of a mass stranding that may provide clues only after careful scrutiny. Ideally, include photographs showing dorsal, lateral and ventral views, and the head with mouth open to expose teeth or baleen. At minimum, attempt a full lateral view of cetaceans and a dorsal view of pinnipeds. For species included in **photo catalogues**, take additional pictures of **identifying characteristics**, e.g., scars on manatees, flukes of humpback whales and callosity patterns on right whales. Photographs should **include a reference scale** of known standard size (e.g., ruler, coin) and a label with the field number, date and location. Make a note of photographs taken, including the roll and frame number.

Rare specimens are especially valuable and require an extra measure to ensure a complete body of data. Consider preparing the entire carcass for removal to a suitable laboratory or museum for study or preservation.

#### **Public Health: A Reminder**

Dead and decaying marine mammal tissues harbor a variety of potentially harmful organisms, some of which can infect humans (*see 12.1, 12.2*). Dangerous consequences from exposure can be reduced by wearing appropriate clothing (protective overalls and rubber gloves), eye protection (safety glasses, sun glasses), and by being careful when handling tissues. Persons should protect open wounds with dressings and avoid contact with fluids or airborne droplets. Keep disinfectant solutions at hand.

## **10.2. Sampling Live Animals**

Take photographs of anatomical or other distinguishing features that will help identify the species or individual. Photograph all lesions. Skin scrapings, biopsies of skin and blubber, and culture swabs for microbiology (Fig. 10.1) are easily obtained from living animals. If possible, and if qualified people are present, a blood sample should be collected, regardless of the animals' condition or probable disposition (Figs. 10.2-10.5) (*see also 10.6*). Referring to Table 10.1, living animals are designated as **Code 1** specimens. **Anyone taking blood samples or performing other medical procedures must comply with state, regional and federal veterinary regulations.**

TABLE 10.1

**Level A Data: Basic Minimum Data**<sup>23,32</sup>

1. Investigator: name and address (institution)
2. Reporting source
3. Species
  - preliminary identification (by qualified personnel)
  - voucher (supporting) material (photographs; specimens, including mandibles with canines from pinnipeds, entire skulls, mandibles with teeth, or tooth counts from odontocetes, or 2 pieces of mid-row baleen from mysticetes)
4. Field number
5. Number of animals, including total and sub-groups (if applicable)
6. Location
  - preliminary description (local designation)
  - latitude and longitude (to 0.1 minute, if possible) with closest named cartographical feature (USGS 1:250,000 series) as determined subsequently in the lab
7. Date (mm\dd\yy), time of first discovery AND of data and specimen recovery
8. Length (girth and weight when possible)(see 10.7)
9. Condition (recorded for both discovery and recovery times)
 

**Codes** (see 10.3) as follows:

  - 1) alive
  - 2) freshly dead (i.e., edible)
  - 3) decomposed, but organs basically intact
  - 4) advanced decomposition (i.e., organs not recognizable, carcass intact)
  - 5) mummified or skeletal remains only
10. Sex (see Figs. 5.1, 6.1, 8.1, 9.1)

**Level B Data: Supplementary On-Site Information**

1. Weather and tide conditions
2. Offshore human/predator activity
3. Presence of prey species
4. Behavior
  - pre-stranding (e.g., milling, directional swimming)
  - stranding (e.g., determined effort to strand, passive, thrashing)
  - after return to sea (e.g., disoriented swimming, listing); note also tag # and color; location of sighting
5. Samples collected for life history studies(see 10.8)
  - teeth, claws, ear plugs or bone for age determination
  - reproductive tracts
  - stomach contents
6. Samples collected for blood studies(see 10.2, 10.6)
7. Disposition of carcass (see Chapter 11)

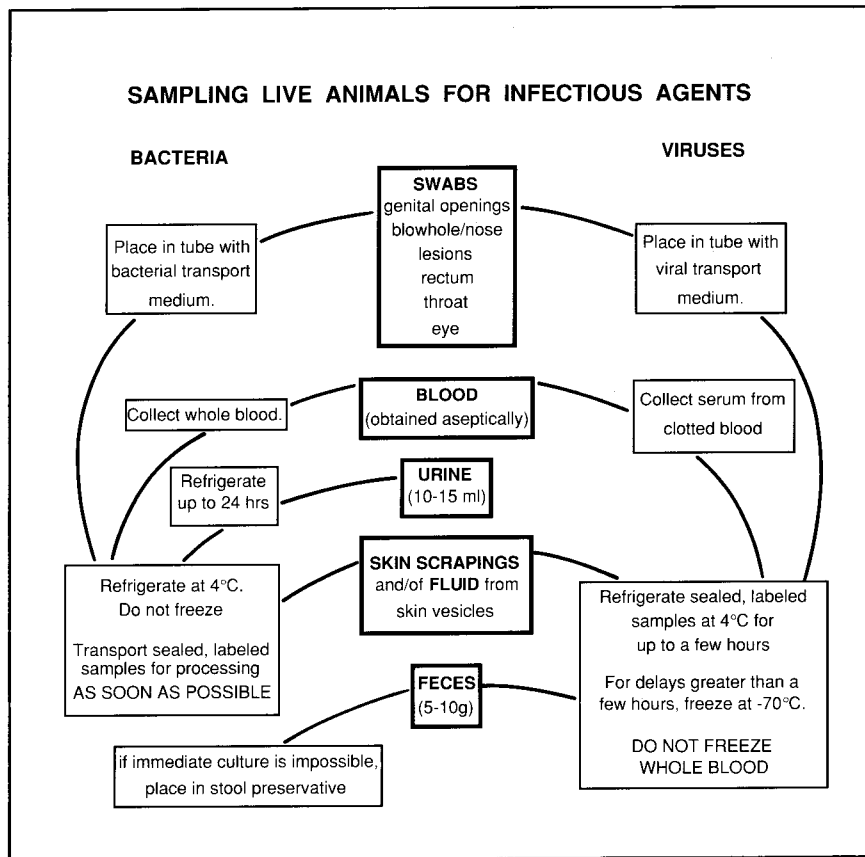
*(continued)*

**TABLE 10.1 (continued)**

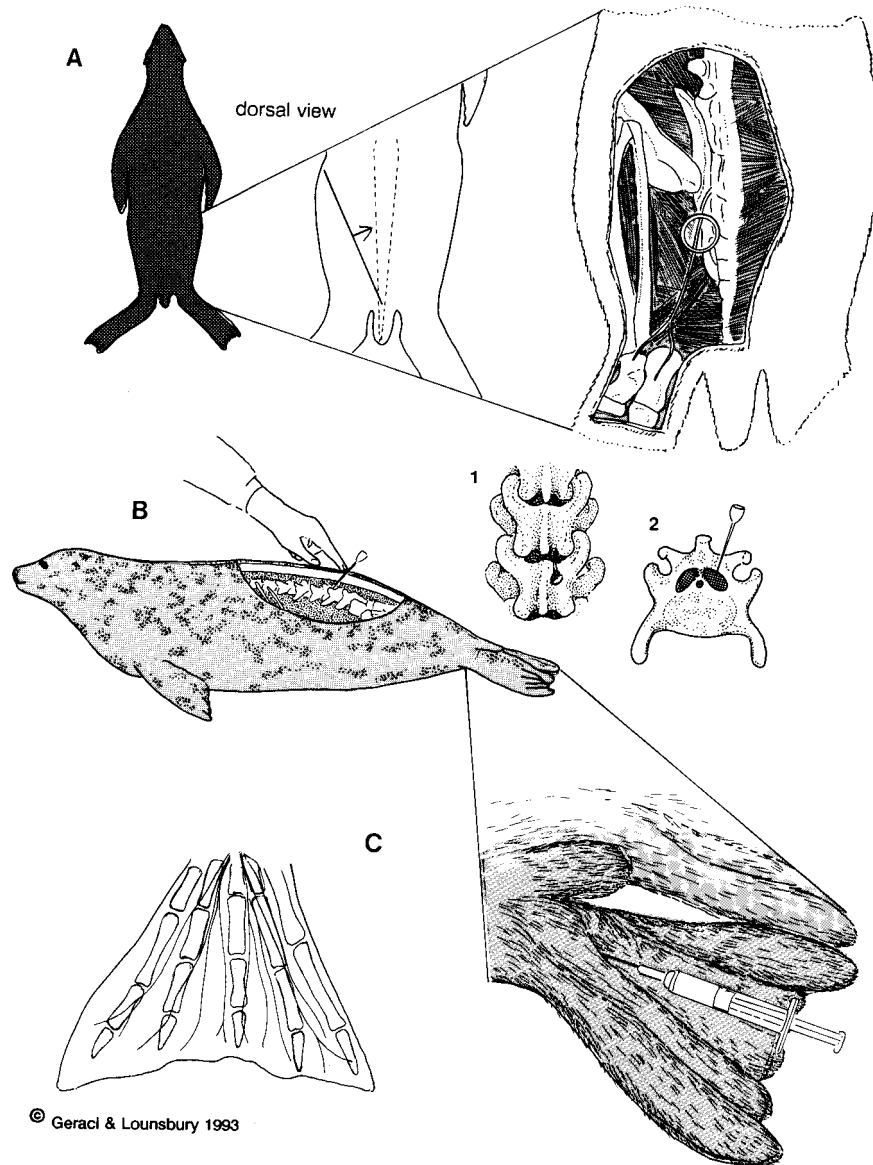
**Level C Data: Necropsy Examination and Parasite Collection**

1. Necropsy (see 10.4)

- collection of tissues for toxicology (see 10.9)
- collection of samples for microbiology (see 10.10)
- collection of tissues for gross and histopathology (see 10.11)
- collection of parasites (see 10.12)



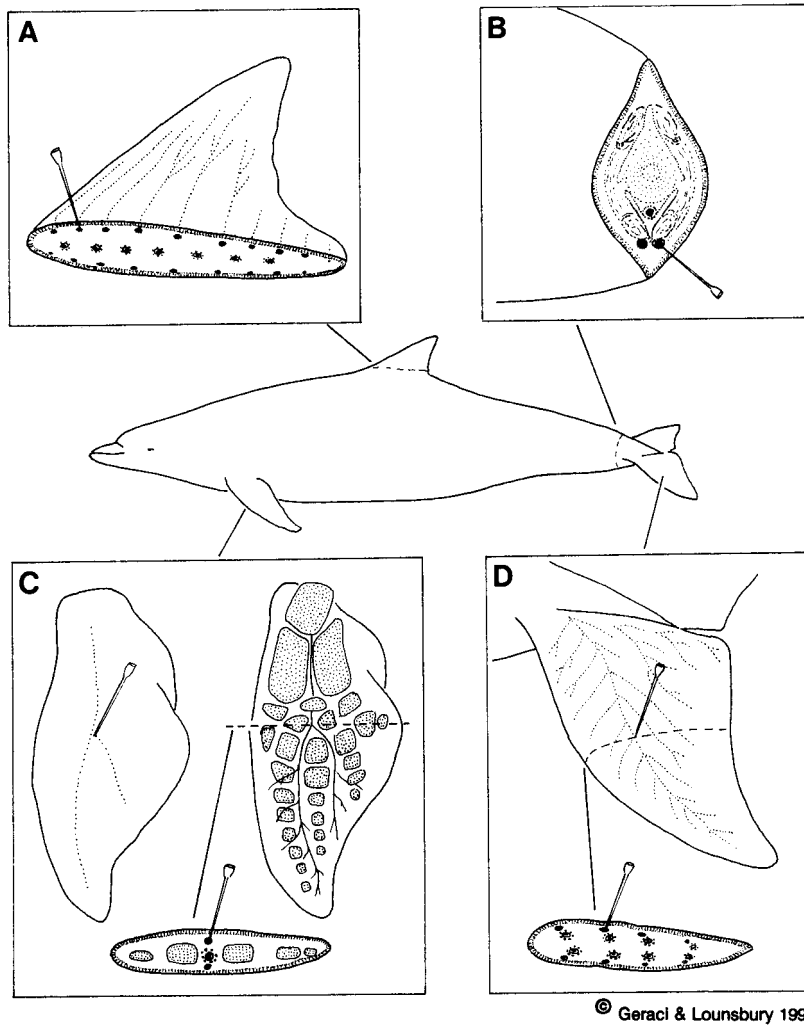
**Fig. 10.1.** Sampling live animals for infectious agents.



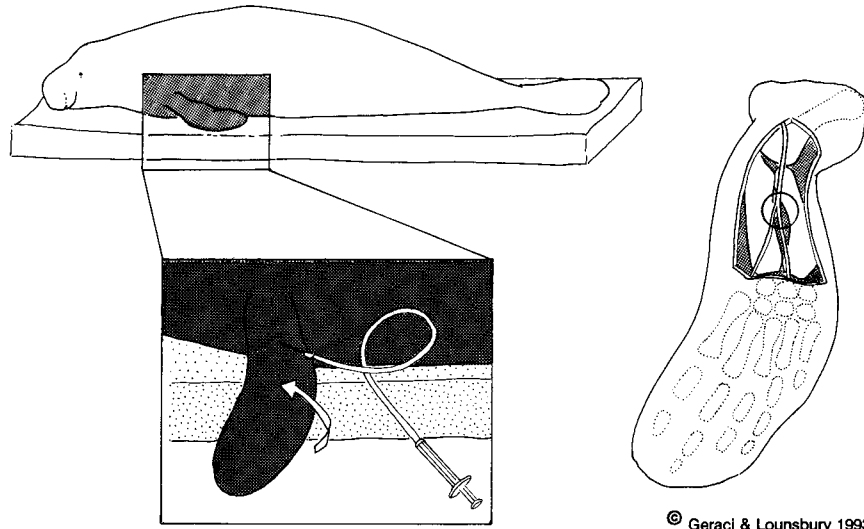
© Geraci & Lounsbury 1993

**Fig. 10.2.** Pinniped blood sampling. **A.** Blood sampling from the caudal gluteal vein of otariids. The needle (18 gauge, 4 cm) is inserted at a point along the pelvic bone approximately perpendicular to the midpoint of a line from knee to base of tail. **B.** Extradural blood sampling technique for phocid and otariid seals. The index finger is used as a guide for inserting the needle between the dorsal spinous processes (1) of the lumbar vertebrae and into the bilaterally divided extradural vein (2) which overlies the spinal cord. **C.** Blood sampling from the hind flipper of a seal. The needle is inserted into the rich vascular network in the metatarsal region, just above the origin of the interdigital webbing on the plantar surface.



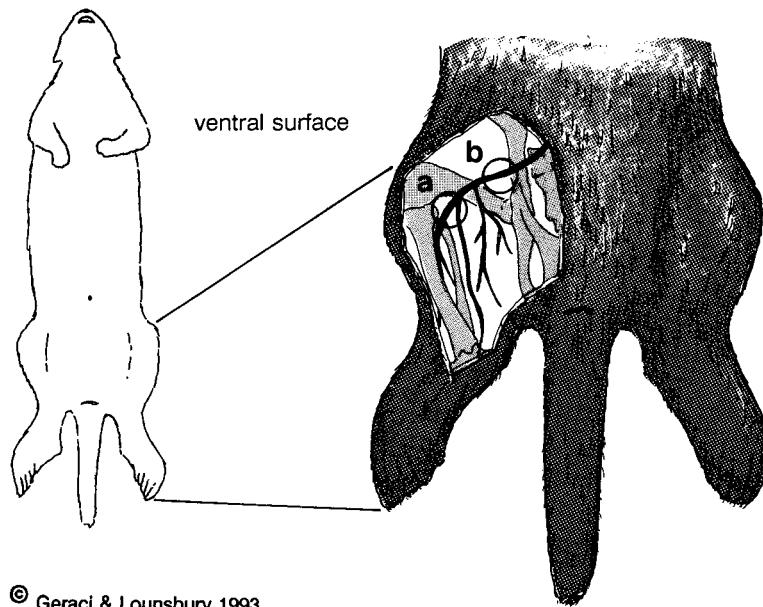


**Fig. 10.3.** Cetacean blood sampling. **A.** Dorsal fin. **B.** Caudal peduncle. **C.** Pectoral flipper. **D.** Flukes. Sampling is carried out at all sites, on small to large cetaceans, using an 18 gauge 4 cm needle. Needle bore should be scaled down for the very small Dall's and harbor porpoises.



© Geraci & Lounsbury 1993

**Fig. 10.4.** Manatee blood sampling. Needle (18-20 gauge, 2.5-4 cm) with extension tube is inserted into the palmar side of the forelimb between the radius and ulna (M. Walsh, Sea World, Inc., Pers. comm.).



© Geraci & Lounsbury 1993

**Fig. 10.5.** Sea otter blood sampling. Blood is drawn from the (A) popliteal vein about 1 cm posterior to the femoral condyles (J. McBain, Sea World, Inc., Pers. comm.) or (B) from the proximal third of the femoral vein (or from the jugular vein if the animal is under anesthesia). (Adapted from Williams 1990.)

### 10.3. Evaluating a Carcass

Before obtaining tissue samples from dead animals, the quality of the carcass must be evaluated to determine its suitability for the intended study.

#### External Features

The condition of a marine mammal carcass cannot be evaluated solely by its outward appearance or estimated by knowing the time since death. The rate of decomposition is influenced more by body temperature in a robust (thick blubber layer) animal and by environmental temperature in one that is lean. Larger, rotund carcasses retain heat longer than smaller, thin ones. Cetaceans (except the *Balaenidae*) sink initially at death, then float days or weeks later when buoyed by decomposition gases, and arrive ashore outwardly unchanged but internally decomposed. At the other extreme, seagulls may begin gouging the eyes and penetrating the skin and blubber of the jaw and body openings of a living dolphin, perhaps already mutilated by shells and rocks during stranding. By the time the animal dies, the carcass may already appear to be spoiled. A dead harp seal, buoyant with thick winter blubber, may float ashore as soon as it dies. In summer or when ill, leaner carcasses come ashore only after they sink and refloat.

**Rigor mortis**, defined as stiffening of the body after death, is an indicator of the time of death in many species<sup>33</sup>. Limited studies on marine mammals<sup>12</sup> allow us to make only some generalities on small animals, mainly pinnipeds. The process begins within hours after death, varying with the animal's terminal condition and the ambient temperature. The duration is also variable, but is measured in hours or, under cool conditions, perhaps a day or two. The presence of rigor mortis indicates a carcass in moderately good condition (**Code 2**).

The skin, eyes, and exposed mucous membranes dry rapidly after death and are not an accurate gauge of quality of a carcass out of water. These tissues retain their vital appearance longer in water or with humidity or precipitation and then, too, may be unreliable indicators.

**Bloating** is generally a sign that a carcass is not fresh (**Code 3**), though some diseases may cause gas production in tissues even in live animals. Tell-tale signs of decomposition include a protruding tongue and penis. At some point the gases escape, and it may not be obvious whether the process has just begun or ended.

**The only reliable approach is to examine the carcass internally.**

### Internal Features

The **blubber** of a fresh carcass is firm, mostly white, and only moderately oily. With time, it may become tinged with blood (imbibition) from underlying tissues. Eventually, the oil begins to separate (**delipidation**) and pool, leaving behind a lacework of greasy connective tissue fibers.

Fresh **muscle** is dark (except in fetuses and manatees) and firm, and the bundles are distinguishable and easily separated. As a carcass decomposes, the muscles become soft, pale, translucent, and pasty; fiber bundles become almost indistinguishable.

The **rate of decomposition** may be increased by the animal's terminal condition, such as a generalized infection with increased body temperature (fever) or wounds that expose the body to rapid bacterial invasion<sup>33</sup>. Because blood tends to promote the process, decomposition is retarded in animals that bleed to death.

The rate of decomposition of an internal organ is related to temperature, the amount and arrangement of connective tissue, and proteolytic enzyme content. Peculiar to marine mammals other than the manatee is the abundance of hemoglobin and myoglobin that, in contact with tissues, accelerates decomposition. **Skin, blubber and muscle** can remain intact and may even show gross lesions for as long as 7 to 9 days after death<sup>12</sup>. The **heart and lungs** maintain their integrity for perhaps 2 or 3 days, while **adrenal glands, liver, spleen, brain, kidney**, and mucosa of the **digestive tract** decompose with frustrating rapidity.

### Carcass Classification

Despite uncertainties inherent in determining the stage of decomposition, any study on carcasses requires a system to define the quality of the material. The following is an expanded version of the code system established by the Smithsonian Institution's Scientific Event Alert Network. Animals or carcasses are assigned to one of five basic categories, determined by specific characteristics (see Table 10.1, **Level A Data**).

#### CODE 1: Live Animals

**Uses:** morphometrics; limited life history, external gross pathology, parasitology and microbiology; biopsies; blood studies, including DNA analysis and clinical chemistry.

#### CODE 2: Carcass in Good Condition (Fresh/Edible)

**Uses:** morphometrics; DNA analysis; life history; parasitology; gross and histopathology; toxicology; microbiology; limited blood studies.

**Characteristics:** normal appearance, usually with little scavenger damage; fresh smell; minimal drying and wrinkling of skin, eyes and

mucous membranes; eyes clear; carcass not bloated, tongue and penis not protruded; blubber firm and white; muscles firm, dark red, well-defined; blood cells intact, able to settle in a sample tube; serum unhemolyzed; viscera intact and well-defined; gut contains little or no gas; brain firm with no discoloration, surface features distinct, easily removed intact.

**CODE 3: Fair (Decomposed, but organs basically intact)**

**Uses:** morphometrics; DNA analysis; limited life history; parasitology; gross pathology; marginal for toxicology (useful for metals, marginal for organochlorines, poor for biotoxins); histopathology of skin, blubber, muscle, lung, and possibly firm lesions.

**Characteristics:** carcass intact, bloating evident (tongue and penis protruded) and skin cracked and sloughing; possible scavenger damage; characteristic mild odor; mucous membranes dry, eyes sunken or missing; blubber blood-tinged and oily; muscles soft and poorly defined; blood hemolyzed, uniformly dark red; viscera soft, friable, mottled, but still intact; gut dilated by gas; brain soft, surface features distinct, dark reddish cast, fragile but can usually be moved intact.

**CODE 4: Poor (Advanced decomposition)**

**Uses:** morphometrics; limited life history (teeth, baleen, bone, claws, some stomach contents, possibly reproductive condition); limited DNA analysis, parasitology, and gross pathology.

**Characteristics:** carcass may be intact, but collapsed; skin sloughing; epidermis of cetaceans may be entirely missing; often severe scavenger damage; strong odor; blubber soft, often with pockets of gas and pooled oil; muscles nearly liquified and easily torn, falling easily off bones; blood thin and black; viscera often identifiable but friable, easily torn, and difficult to dissect; gut gas-filled; brain soft, dark red, containing gas pockets, pudding-like consistency.

**CODE 5: Mummified or Skeletal Remains**

**Uses:** morphometrics; limited life history (teeth, baleen, claws, bone) and DNA analysis.

**Characteristics:** skin may be draped over skeletal remains; any remaining tissues are desiccated.

#### 10.4. Protocols—General Considerations

In our zeal to gather as much information as we can from a carcass, we may spend time, energy and resources collecting specimens of marginal or no value. **The effectiveness of the operation will be increased by following clear protocols using only suitable carcasses.** In a mass stranding, it is better to concentrate on the freshest specimens, not necessarily the most convenient, and to perform the procedures as soon as possible. Marking carcasses with colored ribbons or tags to indicate the stage of protocol completion will increase efficiency and reduce confusion (*see 7.7*).

The best samples are obtained through careful dissection, avoiding contamination of tissues by contact with dirty instruments, other organs, or body fluids. At the outset, be sure the type and quality of equipment and packaging materials are satisfactory for the task at hand.

**With thoughtful planning, it will be possible to obtain morphometric data first, followed by external samples for microbiology. Once the carcass is opened, tissue samples for microbiology and toxicology take precedence, followed by sampling for histopathology, parasitology, and life history (Table 10.2). This order follows the sequence of general dissection and examination (*see 10.5*).**



TABLE 10.2 Sample Selection and Preservation Methods

Tissue	life history	bacteriol.	virology	histopath.	toxicology			parasites
					org. <sup>c</sup>	inorg. <sup>d</sup>	biotox.	
skin	2,6			4				9
blubber				4	1→3*		1→3	9
blood <sup>a</sup>		1	3 <sup>e</sup>					
muscle				4				9
thyroid				4				
thymus				4				
heart		1		4				9
lung		1	3	4				9
lymph nodes		1	3	4				
adrenal				4				
liver		1	3	4	1→3*	1→3*	1→3	9
pancreas				4				9
kidney			3	4		1→3*		9
bladder				4				
repro. tract	4			4				9
mammary	4			4				9
stomach				4				9
stomach cont.	2,5						3	
intestine				4				9
spleen		1	3	4				
brain			3	4				9
pituitary				4				
teeth	1,2,5							
earplugs	4							
bone	2,8	1						
claws	5*							
urine		1	3					
other fluids <sup>b</sup>		1	3					
feces	2,5	7		4				

(continued)

**TABLE 10.2 (continued)****Preservation methods:**

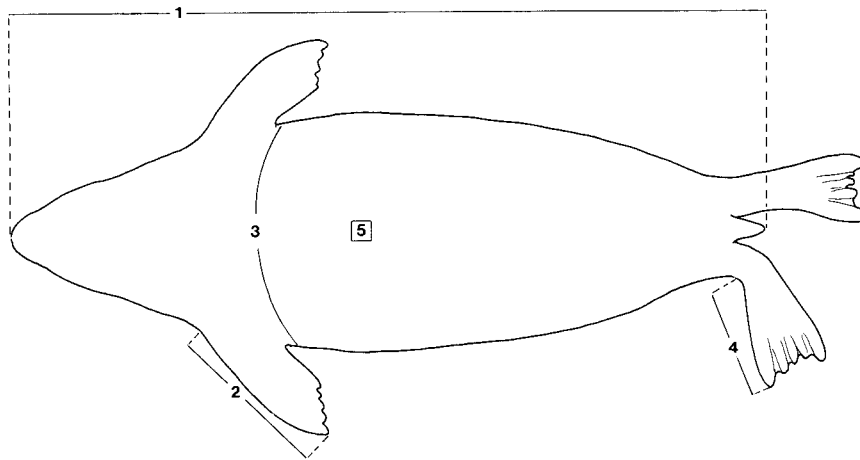
1. Refrigerate (0-4°C) for transport to laboratory.
2. Freeze at -20°C.
3. Freeze at -70°C (\*after trimming contaminated surfaces).
4. Fix in 10 percent neutral buffered formalin (place small subsamples of selected lesions in 2 percent glutaraldehyde for EM study).
5. Preserve in ethanol (\*use 10 percent glycerine in 70 percent ethanol).
6. Preserve in formol-urea solution, or saturated NaCl with 5 percent DMSO.
7. Place in stool preservative.
8. Clean and dry.
9. Preserve endoparasites in AFA (see 10.12) and ectoparasites in 5 percent glycerine in 70 percent ethanol; place samples of associated lesions in 10 percent neutral buffered formalin.
  - a Collect samples for hematology and clinical chemistry in EDTA, heparin, and EGTA tubes.
  - b Pericardial, peritoneal, pleural.
  - c Package in teflon, aluminum foil, or borosilicate glass.
  - d Package in teflon, polyethylene, or borosilicate glass.
  - e Serum or plasma; do not freeze whole blood.

**10.5. Examining the Carcass**

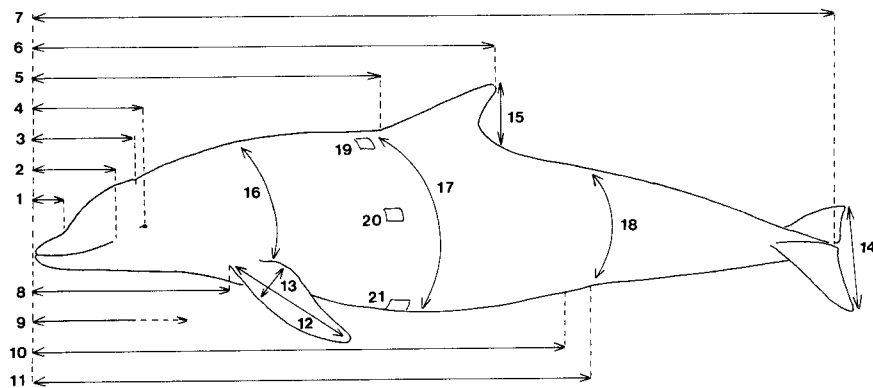
Procedures for dissecting and examining carcasses vary with the size and species of the subject and personal preference of the investigator. The following outline, condensed from specific protocols<sup>6,17,28,65</sup> and personal experience, is one approach to carrying out a systematic examination of a carcass.

1. **IDENTIFY** the species and determine the sex (Figs. 5.1, 6.1, 8.1, 9.1). **DESCRIBE** and **PHOTOGRAPH** form, color pattern, scars, other distinguishing features (e.g., number and position of teeth or characteristics of baleen), injuries, external lesions, etc.; for populations included in photo catalogues, photograph pertinent characteristics (e.g., callosities of right whales). Tooth counts (see 5.12, 6.13) are taken from one side of the upper and lower jaw.
2. Take **MEASUREMENTS** (see 10.7, Figs. 10.6-10.8, 10.13), including blubber thickness (Fig. 10.9); obtain body **WEIGHT** if possible.
3. Conduct the **EXTERNAL EXAMINATION** (Fig. 10.10). Note general condition (e.g., emaciation); describe and illustrate scars, lesions, parasites and discharges. Take samples as appropriate. Distinguish "crush" wounds from "high velocity" wounds (i.e., bullets, propellers); the latter may show shattering and scattering of bone fragments along the wound tracks. Distinguish between a gunshot wound and any other by locating the bullet; take samples from along

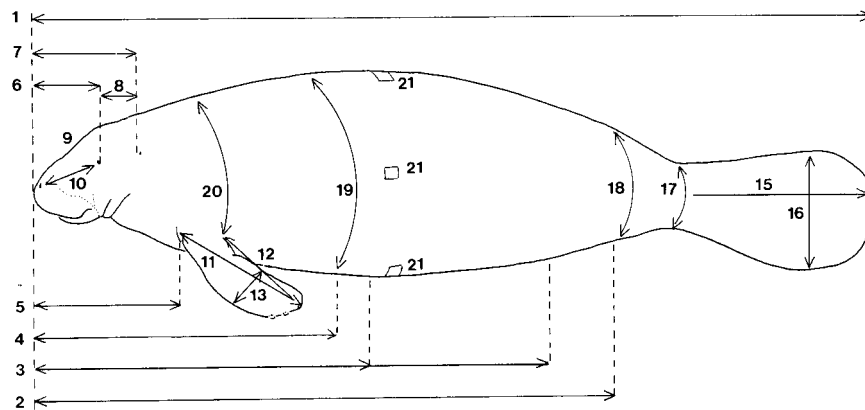




**Fig. 10.6.** Measuring pinnipeds. **1.** Standard length, from tip of snout to tip of tail. **2.** Anterior length of foreflipper. **3.** Axillary girth. **4.** Anterior length of hind flipper. **5.** Blubber thickness over posterior end of sternum. (Modified from Scheffer 1967; Winchell 1990.)



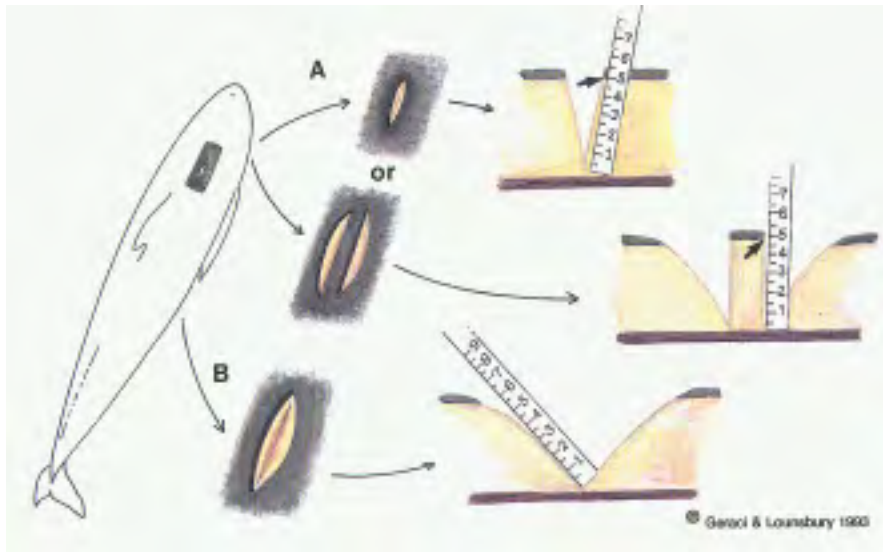
**Fig. 10.7.** Measuring cetaceans. **1.** Snout to melon. **2.** Snout to angle of mouth. **3.** Snout to blowhole. **4.** Snout to center of eye. **5.** Snout to anterior insertion of dorsal fin. **6.** Snout to tip of dorsal fin. **7.** Snout to fluke notch. **8.** Snout to anterior insertion of flipper. **9.** Snout to caudal end of ventral grooves (when present). **10.** Snout to center of genital aperture. **11.** Snout to center of anus. **12.** Flipper length. **13.** Flipper length. **14.** Fluke width. **15.** Dorsal fin height. **16.** Girth: axillary. **17.** Girth: maximum (specify location). **18.** Girth: at level of anus. **19.** Blubber thickness: dorsal (anterior and lateral to dorsal fin). **20.** Blubber thickness: lateral. **21.** Blubber thickness: ventral. As a minimum, measure 7, 12, 14, 17 and 21. (Modified from Norris 1961.)



**Fig. 10.8.** Measuring manatees. 1. Tip of snout to tip of fluke. 2. Tip of snout to center of anus. 3. Tip of snout to center of genital aperture. 4. Tip of snout to center of umbilicus. 5. Tip of snout to anterior insertion of flipper. 6. Tip of snout to center of eye. 7. Tip of snout to external ear. 8. Center of eye to ear. 9. Distance between centers of eyes. 10. Center of eye to center of nostril (same side). 11. Flipper length, anterior insertion to tip. 12. Flipper length, axilla to tip. 13. Maximum width of flipper. 14. Perpendicular length of teat, right and left (see Fig. 8.1 for location). 15. Base of fluke to posterior tip. 16. Maximum width of fluke. 17. Girth at fluke base. 18. Girth at anus. 19. Girth at umbilicus. 20. Girth at axilla. 21. Thickness of skin: dorsal, lateral, ventral. Thickness of blubber-Outer: dorsal, lateral, ventral. Inner: dorsal, lateral, ventral. Girths and flipper lengths recorded on fresh animals **Code 2** only. (Adapted from Bonde *et al.*, 1983.)

the projectile path (preserve in 10 percent neutral buffered formalin) to determine (by histological examination) whether the injury occurred before or after death. Check for evidence of other **HUMAN-RELATED INJURY** (e.g., propeller scars, entanglement)<sup>6,29</sup>. Look for **TAGS** or tag scars (i.e., tear in rear flipper or dorsal fin). Examine the **UMBILICUS** of neonates. Examine the **MAMMARY GLANDS**; attempt to express milk, note color and consistency, make smears for examination for parasite ova. In odontocetes, extend the **PENIS** from its sheath; examine the surface and soft tissues at the base for small cauliflower-like lesions.

4. Examine the **MOUTH** and **TEETH/BALEEN**; note abnormalities (i.e., worn or broken teeth, gum and tongue condition, obstructions) or parasites. For cetaceans, note number and position of teeth, or the number, color, and length of the longest baleen plates (Fig. 10.16). Check the **BLOWHOLE/NASAL PASSAGES** for parasites, discharges, or obstructions; make smears for parasitologic examination. Examine the **EYES** for clarity, surface lesions, injuries and



**Fig. 10.9.** Measuring blubber thickness. **A.** To minimize distortion, measure within a short incision or measure the column of blubber between two longer incisions. **B.** A long incision results in distortion of the blubber and inaccurate measurements.

discharges. Take external swabs for microbiology before opening the carcass.

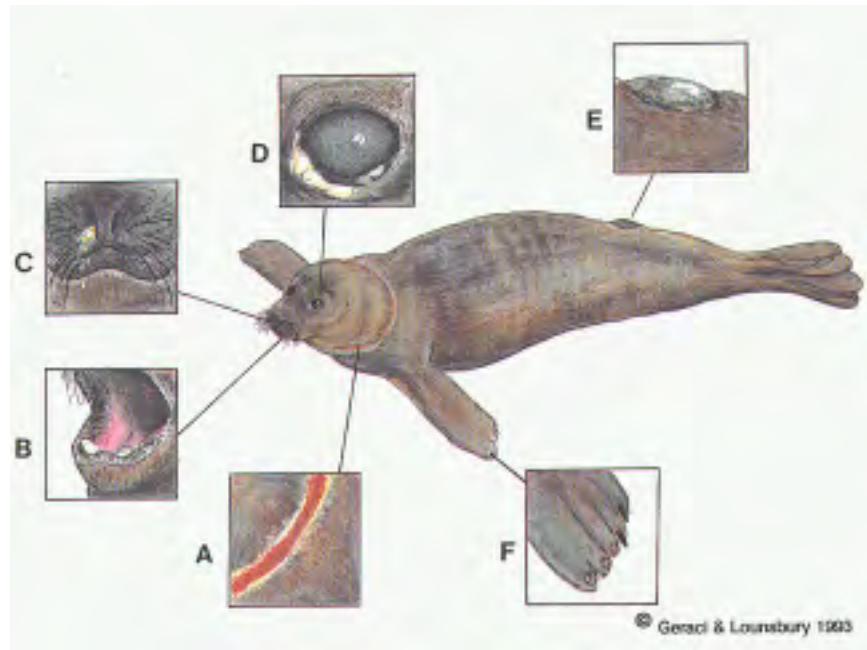
5. Open the carcass for **INTERNAL EXAMINATION**, preferably on or abutting a plastic or teflon sheet. (In cetaceans, a section of skin and blubber can serve as a small work surface.) Have all instruments, collecting jars, labels and preservatives on hand before making the first incision. For pinnipeds, manatees and sea otters (Figs. 10.11-10.13), position the carcass on its back; make a mid-line incision through skin, blubber and muscle from jaw to anus, without penetrating the abdominal cavity. Fold back the skin and blubber from each side; remove or deflect the forelimbs, including the scapula. Be prepared to remove a flipper or claws for age determination. Position a cetacean carcass on its side, preferably left side up (for easier removal of rib cage). Remove portions of the lateral body wall and dorsal musculature (Fig. 10.14).

**AT EACH STAGE OF THE EXAMINATION, SAMPLE TISSUE AS SOON AS IT IS EXPOSED. FIRST TAKE SAMPLES FOR TOXICOLOGY (10.9; Figs. 10.17-10.19) AND MICROBIOLOGY (10.10; Figs. 10.21-10.22). BE PREPARED TO DESCRIBE, PHOTOGRAPH AND REMOVE TISSUES FOR HISTOPATHOLOGY (10.11; Figs.**

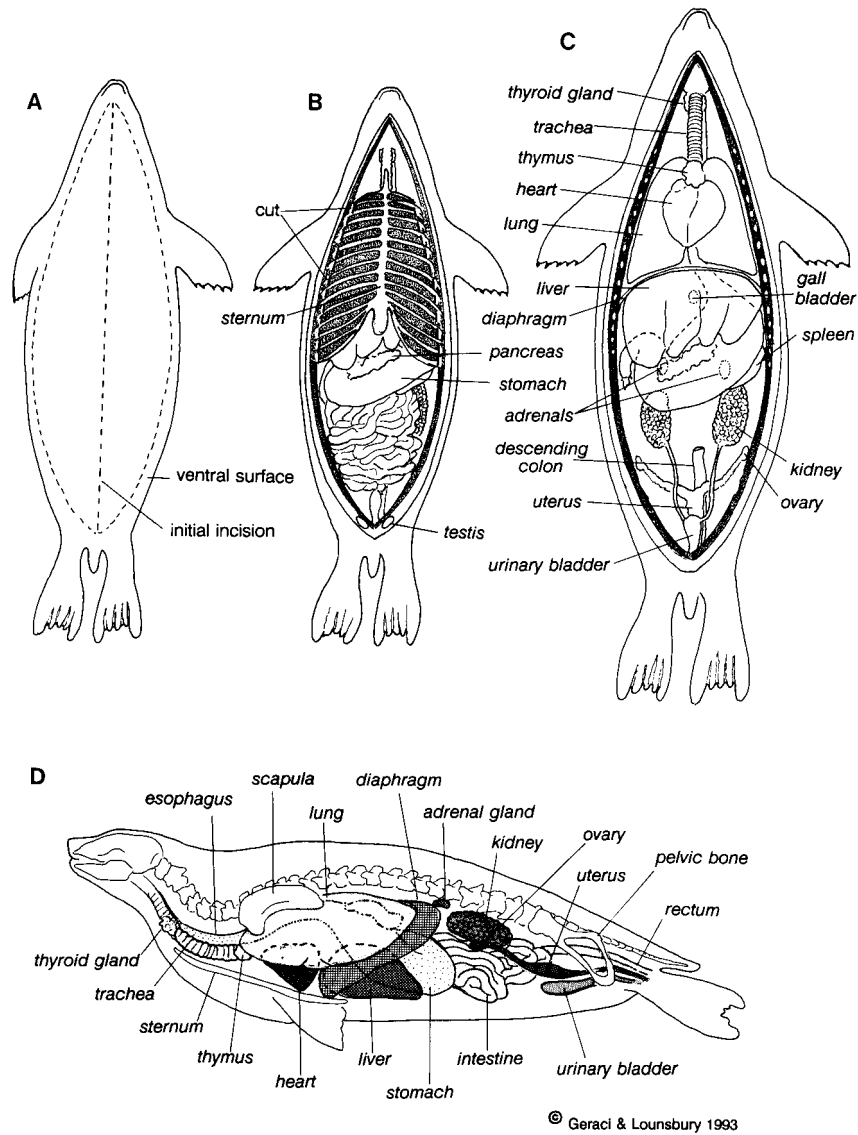


10.24, 10.25). **SEARCH SPECIFIC LOCATIONS** (Figs. 10.26-10.31) **FOR PARASITES** (10.12). **PACKAGE AND LABEL SAMPLES IMMEDIATELY.**

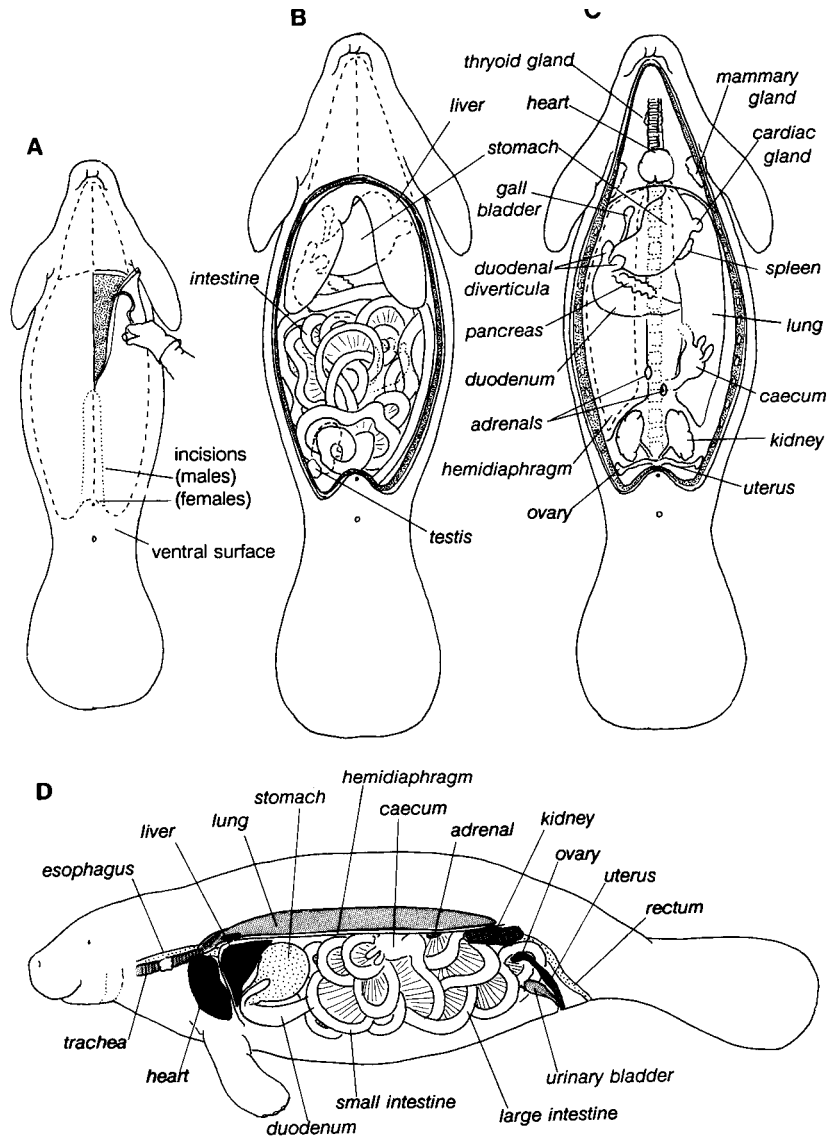
6. Examine the **BLUBBER** or **SUBCUTANEOUS FAT**; note visible parasites (cetaceans); sample for toxicology. Dissect the **MAMMARY GLANDS**. Examine the superficial **FASCIA** (cetaceans) for parasite tracts (white, noodle-like structures). Note **MUSCLE** color, texture, and abnormalities.
7. Cut through the abdominal musculature to expose the **ABDOMINAL CAVITY**, but avoid puncturing the intestines. Examine with organs in place, noting color, consistency, and abnormalities (e.g., fluids, lesions, discolorations, adhesions). Examine the **MESENTERIES** and **MESENTERIC LYMPH NODES**. In neonates, observe the



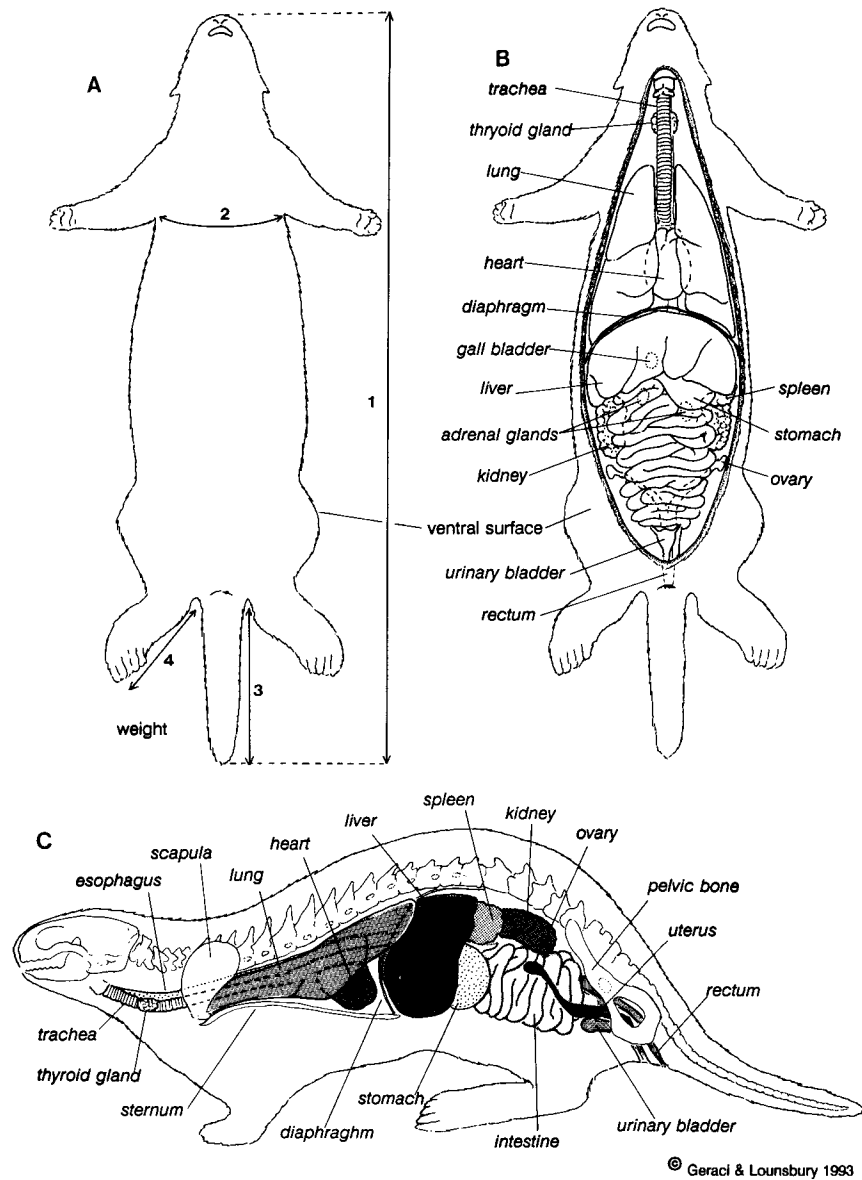
**Fig. 10.10.** The external examination: examples of external pathologic conditions. **A.** Circumferential laceration, neck. **B.** Broken (fractured) tooth. **C.** Unilateral nasal discharge. **D.** 1) Corneal opacity, diffuse. 2) Ocular (conjunctival) discharge. **E.** Oval, hairless, smooth gray nodule (give dimensions). **F.** Three missing claws; possible nailbed inflammation. (Descriptions courtesy B. Wilcock, Ontario Veterinary College, University of Guelph, Guelph, Ont.)



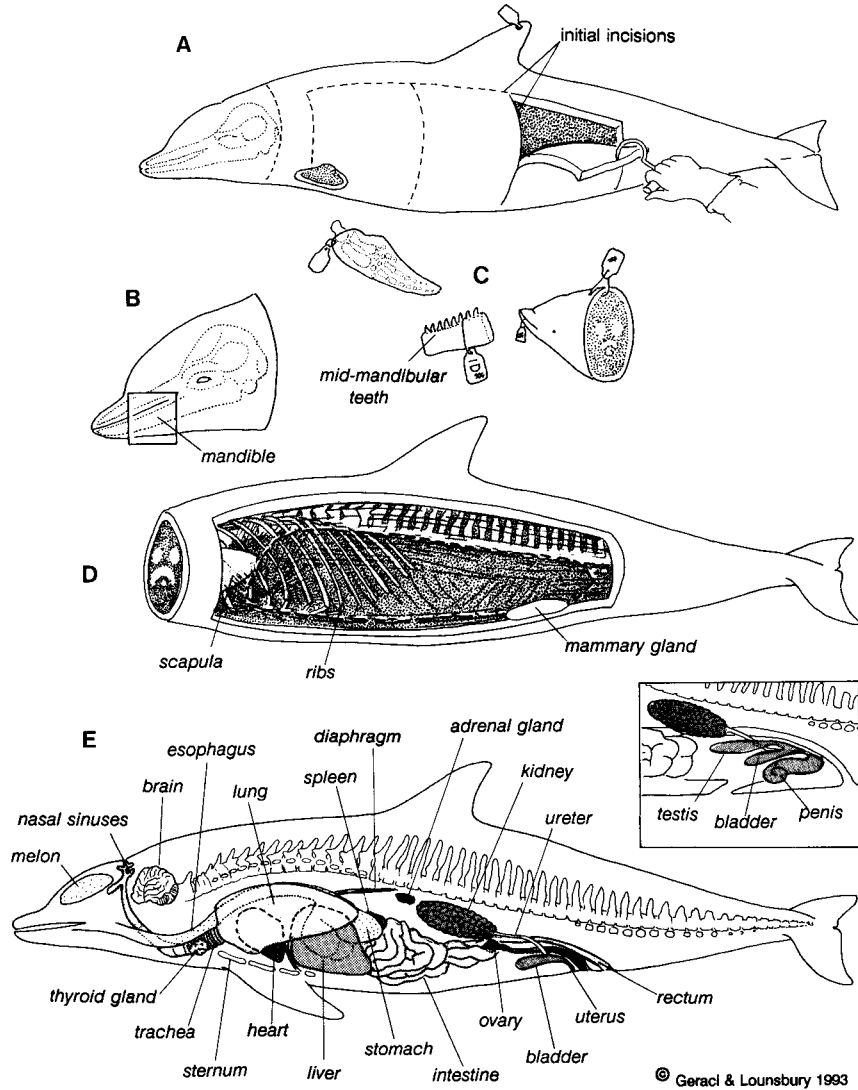
**Fig. 10.11.** Pinniped dissection and internal anatomy. **A.** Initial incisions. **B.** Ventral view of superficial viscera before removal of sternum and costal cartilages. **C.** Ventral view of major internal organs after removal of intestines (redrawn and modified from Fay *et al.* 1979; Winchell 1990). **D.** Lateral view of major internal organs of a phocid seal (modified from Rommel 1990).



**Fig. 10.12.** Manatee dissection and internal anatomy. **A.** Incisions for manatee dissection. **B.** Major internal organs before opening of pericardial cavity. **C.** Major internal organs after removal of liver, intestines, and left hemidiaphragm. **D.** Lateral view of major internal organs. (Redrawn and modified from Bonde *et al.* 1983.)



**Fig. 10.13.** Sea otter measurement and internal anatomy. **A.** Measurements. 1. Total length from snout to tip of tail. 2. Axillary girth. 3. Length of tail. 4. Length of foot. **B.** Ventral view of major internal organs (redrawn and modified from Stoskopf and Herbert 1990). **C.** Lateral view of major internal organs (adapted from Barabash-Nikiforov *et al.* 1947; Stoskopf and Herbert 1990).



**Fig. 10.14.** Cetacean dissection and internal anatomy. **A.** Initial incisions for removal of skin and blubber. **B.** Site of mandibular tooth collection for age determination. **C.** Labeled voucher specimens and samples for age determination. **D.** Opening in lateral body wall in relation to skeletal structure. **E.** Lateral view of major internal organs, female and (inset) male (adapted from Rommel 1982, 1990).



umbilical connections to the liver and bladder. Check for cestode cysts in cetaceans (Fig. 10.28).

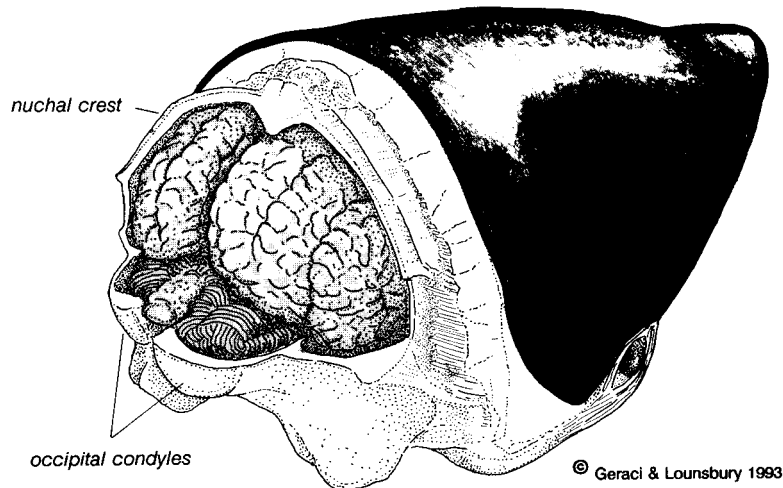
- A. Move the stomach and intestines aside and, using the kidneys as landmarks, locate, remove and examine the **ADRENAL GLANDS**. Collect, package separately and label, including "right" or "left".
- B. Remove and examine the **SPLEEN**; note size, texture and character of a cut surface. Carefully remove the **GASTROINTESTINAL TRACT** and associated organs, first tying off the stomach near the base of the esophagus and at the colon. Examine the peritoneum and abdominal cavity. Spread the GI tract out on a clean surface (away from the carcass) for examination. Remove and examine the **PANCREAS**; note the degree of scarring or fibrosis in cetaceans; dissect open the **HEPATOPANCREATIC DUCT** (in cetaceans) and check for trematodes (flukes). Dissect the gut free from the mesentery. Examine the **STOMACH** surface for perforations. Collect the stomach, with contents, from small animals after first tying it off at the duodenum; freeze for later examination. Alternatively, open the stomach into a plastic bag or bucket and collect the contents (see 10.8); note any ulcerations, foreign objects or parasites, both free and embedded in the mucosa (grape-like clusters in the first and second chambers of cetaceans). Examine the external surfaces of the **INTESTINES** for nodules, segmented discoloration, or adhesions. Open and examine the gut for hemorrhage, character of the mucosa, parasites, and obstructions; describe the contents. Note the texture of the **OMENTUM** and **MESENTERIES**; check for acanthocephalan parasites (spiny-headed worms) in pinnipeds.
- C. Remove and examine the **LIVER**, noting surface texture and color. Cut the lobes in several places in order to examine the internal structure. Open the **GALL BLADDER** (none in cetaceans) and **BILE DUCTS**; examine for trematodes.
- D. Examine the **KIDNEYS** for adhesions, abscesses, or hemorrhage; remove by cutting them away from the dorsal musculature. Slice in several places and examine the interior for stones or cysts. Examine the **URETERS** and **BLADDER**. Aspirate urine with a syringe and needle (in males this can be collected from the penis by squeezing the bladder), check the color, and save for later analysis. Open the bladder and check for stones. In great

whales and beaked whales, examine the vessels and urinary ducts for nematodes.

- E. Remove and examine the **REPRODUCTIVE TRACT**; note presence of a fetus, tumors, abscesses, or unusual amounts of fluids. Record the weight, length and sex of any fetus. Collect the whole fetus for toxicology studies. Examine the ovaries for corpora lutea; if present, take special care to locate the fetus or collect the entire reproductive tract. Examine, weigh and measure the testes. Package the gonads separately and label "left" or "right" (freeze or fix in 10 percent neutral buffered formalin). (Examination for and counting of corpora albicantia and corpora lutea, and checking the epididymis for sperm are best done in the laboratory. In dolphins, urine may also contain microscopic evidence of sperm.)
8. Open the **THORACIC CAVITY** (pinnipeds, sea otters, and manatees) by cutting the rib cage along the sides at the junctions of the ribs and costal cartilages (Fig. 10.11); remove the sternum and attached cartilages. In cetaceans, cut the articulations between the ribs and sternum, and the ribs and vertebrae (cranial ribs have double articulations along the back) (Fig. 10.14). Attempt to disarticulate rather than cut the ribs; the former may be easier on a large cetacean. (Large baleen whales often float in on their backs; a ventral midline incision along the small cartilaginous joints of the sternum will separate the thorax, and the whale's weight will help open the carcass.) **Cover the tips of fractured or cut bones to prevent personal injury.** Examine the thoracic cavity with organs in place; note abnormalities (e.g., discolorations, excess fluids, lesions, adhesions). Examine the **PLEURA** and **DIAPHRAGM**. Note size, color and consistency of the **THYMUS**. Sample pericardial fluid with a sterile syringe before opening the pericardium, or introduce a swab through a small incision.
    - A. In small animals remove the **PLUCK** (heart, lungs, trachea, and esophagus) intact by cutting the tongue from the lower jaw and pulling it backward, severing connective tissue attachments and hyoid bones. Note any congestion or hemorrhages in the muscles of the thoracic inlet. Place the pluck on a clean surface, ventral side up, for dissection.
    - B. Remove and examine the **THYROID GLAND**. Note size, shape, and consistency.

- C. Open and examine the **ESOPHAGUS**; check for ulcers, obstructions and migrant stomach parasites. In cetaceans, the **LARYNGEAL TUBE** is now exposed for examination.
  - D. Examine the **LUNGS** for color, consistency and texture. Note the condition of the bronchial lymph nodes. In cetaceans, examine a lung-associated lymph node and sample for histopathology. Open the **TRACHEA** and **BRONCHI**, continue dissection through to small airways and into the parenchyma of lungs. Note characteristics of airway fluid (i.e., clear, frothy, hemorrhagic). Collect any parasites present. Describe and sample areas that appear to stand out in marked contrast to the main body of tissue. Aspirate fluid to check for the presence of sea water.
  - E. Examine the **HEART**. Note color and quantity of pericardial fluid, and amount of coronary fat. Examine for pale areas, hemorrhages or evidence of congenital defects. Sample blood from the right ventricle. Open the heart following the course of the circulation— from right atrium to ventricle into pulmonary artery, and left atrium to ventricle into aorta; note thickness of the walls and irregularities of valve leaflets. Check for nematodes (seals: right ventricle and pulmonary artery; cetaceans: left atrium and ventricle). Note presence and nature of clots.
9. To collect or examine the **SKULL**, disarticulate the head between the skull and the first cervical vertebra; secure a tag for identification (Fig.10.14).
  10. Examine the **MIDDLE EAR** and **PTERYGOID SINUSES** of cetaceans for parasites by placing the head upside down and dissecting away the lower jaw. Take time and care to free all tissue attachments at the angle of the jaw; the alternative of prying open the mandible with force will crush the tympanic bones. Cut away soft tissue to expose the entrance to the pterygoid sinus; use a bone cutter to dissect deep into this cavity. Rinsing sinuses with saline or water will help flush out concealed trematode parasites.
  11. In fresh carcasses of baleen whales, collect the **WAX PLUG** at the proximal end of the auditory canal<sup>43</sup>; place it in a rigid container with 10 percent neutral buffered formalin for aging studies.
  12. To expose the **BRAIN** (useful only on fresh specimens), remove the top of the skull and cut away the soft tissues over the cranial vault. (Fig. 10.15 shows an approach for cetaceans.) This procedure requires a handsaw, hammer and chisels, and for larger animals, a





**Fig. 10.15.** Removing the cetacean brain. Make two horizontal cuts, one through the occipital condyles and the other posterior to the nuchal crest. Join these laterally with two vertical cuts. A chisel may be needed to break the bony septum that separates the hemispheres. Remove the bony plate to expose the brain, tilt the skull backwards while sliding a hand over the surface of the hemispheres to sever soft tissue connections to the dura and cranial nerves.

sturdy meathook or prybar as well. Examine the exposed brain for color, consistency, lesions and parasites. Fix brain for histology by slicing every 1-2 cm, with some cuts extending deep enough into the cortices for the preservative to reach ventricles; place in 10 percent neutral buffered formalin.

13. Sample **TEETH** for **AGE DETERMINATION**. In odontocetes, they may be extracted from the mandible by cutting down into the gum tissue on either side of the tooth row and prying out at least 6-8 mid-row teeth. Alternatively, use a saw to take a section of mid-mandible with teeth in place for later extraction (Fig. 10.14). Upper canines (or a section of the anterior skull containing them) are the recommended samples for otariids and bearded seals; upper or lower canines, or the first four postcanines (or section of the skull or mandible containing them) for other phocids; and lower postcanines for walruses<sup>17,52</sup>. Collect the lower first premolar (if not possible, the upper) of sea otters<sup>19</sup>. Teeth are not useful for age determination of manatees<sup>16</sup>.

## 10.6. Blood Studies

### Rationale

Blood samples provide an opportunity to evaluate the functional capacity of organs, as one approach to determining what processes might have been responsible for or associated with the stranding event<sup>26,42,58</sup>. A broad spectrum of analyses can be performed, including plasma chemistry, hematology, antibody titers, and toxicology, as a means of investigating a range of pathologic conditions.

**Carcass selection: Code 1** ideal; **2** limited; 3, 4, 5 useless.

Blood samples only have value for clinical pathology when taken from live animals, or within minutes after death. Organs deteriorate rapidly, causing progressive changes in concentrations of blood gases, enzymes and electrolytes, among other parameters. **Samples collected from animals dead for more than a few minutes are useful only for serological studies.**

### Sampling

Freshly dead animals, including those euthanized by lethal injection, can sometimes be sampled in the same way as live ones (Figs. 10.2-10.5). When procedures are carried out more than a few minutes after death, **samples can be taken from the right ventricle of the heart with a syringe and needle**. 20-30 mL of whole blood is enough to run a comprehensive set of analyses. Five tubes should be ready to receive the blood: samples are put **1)** in EDTA for hematology, **2)** in heparin for harvesting plasma, **3)** in a chemically clean tube for separating serum, **4)** in EGTA (ethyleneglycol-bis-N<sub>4</sub>-tetraacetic acid) for catecholamines, and **5)** in sodium citrate for glucose and coagulation studies. **Record times of death and sampling**. Place samples in a cooler or on ice, but do not freeze, and transport to the laboratory as soon as possible for processing.

When a delay of more than about 4 hours is anticipated, centrifuge the blood to separate the plasma or serum; these samples, free of red blood cells, can be frozen if delivery to the laboratory within a day is impossible. A blood smear is useful if samples for hematology cannot be analyzed within 24 hours.

### Ideal

Samples should be obtained before death and analyzed immediately. Serial samples collected several hours apart are particularly informative.

### **Practical**

Rarely do situations allow for blood to be taken from a carcass in good enough condition to be of much use for clinical diagnostics. However, viral antibodies will persist and can be detected in samples taken many hours or even days after death from **Code 2** animals.

### **Precautions**

Samples are easily contaminated with body fluids. Blood cells settle out in the heart and vessels giving misleading values for hematology, and the time of death, if not observed, cannot be reliably established. Red cells can rupture if samples are mishandled or frozen, giving erroneous results.

## **10.7. Morphometrics**

### **Rationale**

Morphometric and descriptive data provide basic biological information and have added value when correlated with factors such as age, stage of maturity, reproductive status, parasitic burden and disease processes. The accumulation of such data results in a better understanding of general population health, demographic trends, and identification of discrete stocks. Studies of organ weights help to define specific physiological adaptations and attributes.

**Carcass Selection: Code 2, 3 ideal; 1, 4, 5 limited.**

**Every carcass provides some morphometric data**, even skeletal remains. The amount available depends on the state of the carcass.

### **Measurements**

Measurements are taken according to the appropriate protocol for the animal (e.g., Figs. 10.6, 10.7, 10.8, 10.13). The procedure is straightforward, requiring one or two persons with a tape-measure and ideally a third to record. Rare species demand a thorough approach **Augment measurements with photographic documentation.**

All measurements can be valuable, but standard length is consistently useful. Except for girth and other specified dimensions, **measurements are always taken in a straight line from point to point**, never following the contours of the animal. **Standard length** is the straight line distance from the tip of the snout (or the melon, if more anterior) to the tip of the tail or notch of the flukes. Girth measurements are useful only when there is no evidence of bloating. The girth of large whales is recorded as 2 times the measured distance between the mid-ventral and mid-dorsal points on one side of the body. Estimated measurements or

weights must be clearly indicated as such on the data sheet, including the basis for the estimate (e.g., partial measurements, visual assessment). **Blubber thickness** (does not include skin) is measured from a perfectly perpendicular cut (Fig. 10.9); distorting the tissue distorts the results.

Counts of **ventral grooves** and descriptions (length, number and color) of **baleen plates**<sup>64</sup> are useful for identification of mysticetes. A count taken of grooves on one side of the body, from the mid-ventral groove upward, can be doubled to give the total figure. Length is measured from the tip of the lower jaw to the end of the longest groove (excluding the mid-ventral) in a straight line parallel to the body axis. Baleen is counted along the outer edge of the series of plates at gum level, as shown in Fig. 10.16; optimally, the number is an average of counts obtained for both sides of the jaw.

### **Ideal**

A complete set of data includes measurements of as many external features as possible, whole body weights, and weights of major organs.

### **Practical**

Rarely are all measurements taken, but even under poor conditions with few resources and no time to spare, it will be possible to obtain standard length, using knots as markers on a rope or string if necessary. Animals or organs too large to weigh intact can be divided and the pieces weighed separately. Metric units are preferred, but any system of measurement can be converted later.

### **Precautions**

Adhere strictly to the protocol, measure uniformly, and always from the same specified point (e.g., from the midpoint of the genital slit and not from either end). **Units of measurement must be consistent and clearly indicated.** In mass strandings, having one or several specified teams perform all measurements will ensure uniformity. Obtaining an accurate standard length of carcasses in rigor mortis, particularly phocid seals in which the neck may lock in a sigmoid position, can be difficult. Options include dissection to cut the neck muscles or waiting for rigor mortis to pass.

## **10.8. Life History**

### **Rationale**

Information on age, genetics, reproductive status, and feeding habits is vital to understanding the general biology of the species, developing

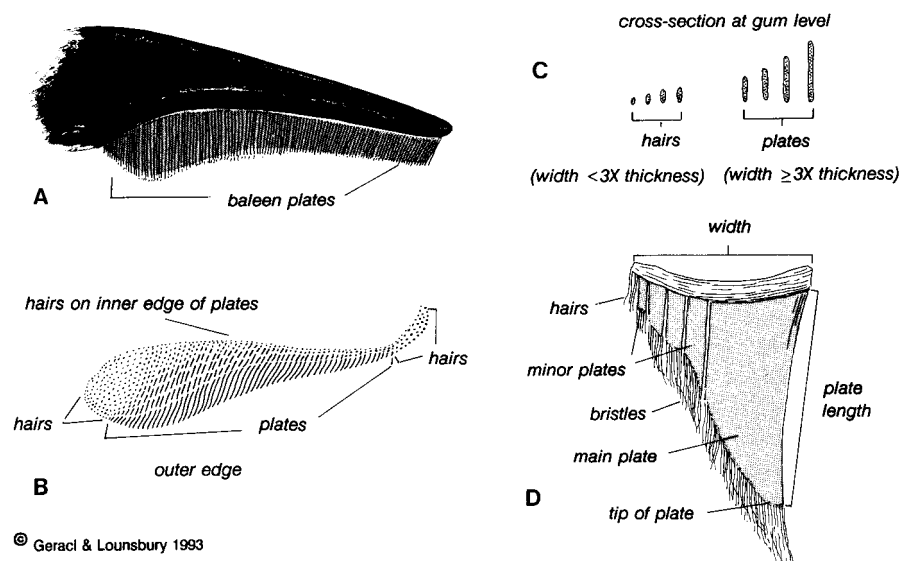
demographic models, identifying discrete stocks, and planning conservation and management strategies. Certain life history information makes interpretation of pathologic and toxicologic data more meaningful. In general, biological data are additive; the more we can obtain on a given specimen, the more meaningful each element becomes.

**Live animals: Code 1** limited.

Live animals are an invaluable resource for obtaining measurements, information on social organization (i.e., age and sex composition of groups) and blood or biopsies for DNA analyses.

**Carcass selection: Code 2, 3** ideal; **4, 5** limited.

Most carcasses provide suitable samples of teeth, claws or skeletal parts for age determination, or tissues for DNA analysis. **Code 2** animals are required for earplugs of baleen whales. Gonads and uterine samples can be taken from **Code 2** and possibly **Code 3** carcasses. Stomach



© Geraci & Lounsbury 1993

**Fig. 10.16.** Counting and measuring baleen. **A.** Baleen series extend along each side of upper jaw; plates at front and rear become smaller and less easily distinguished, eventually just hairs. **B.** Examined in cross-section at gum level, baleen plates have a width at least 3X their thickness; those with width less than 3X the thickness are termed hairs. **C.** Typical baleen plate, consisting of main plate along outer edge, one to several minor plates, and hairs along inner margin; bristles extend from plate margins to form filtering network. Plate length is taken as the straight line distance from the outer edge at gum level to the tip of solid portion of main plate. **D.** Simplified view of arrangement (at gum level) of rows of baleen plates (main and minor plates, hairs) and baleen hairs. Counts are taken along the outer edge of the plates. (Adapted from Williamson 1973.)



contents can be collected from **Code 2**, and some from **Code 3, 4**, and even **Code 5** carcasses (e.g., otoliths and squid beaks).

### Sampling

**Tooth samples** for age determination can be obtained by persons with minimum training (see **10.5 #13**). In the field, teeth (or sections of skull or mandible) can be placed temporarily on ice, frozen, or packed in salt to retard tissue decomposition. In the laboratory, teeth can be extracted, cleaned in an enzyme preparation such as trypsin, labeled, and stored in 70 percent ethanol. It is wise to avoid drying, prolonged boiling, or use of solutions containing glycerine<sup>44</sup>. **Bone** specimens for aging studies can be frozen, preserved in 10 percent formalin or alcohol, or cleaned and dried without affecting the clarity of periosteal layers<sup>34</sup>. The sample should include a bone end incorporating a cartilaginous growth plate or a scar of an old growth plate. Removing **earplugs** of baleen whales requires skill and sometimes heavy equipment to position the skull<sup>43</sup>. Earplugs should be preserved in 10 percent neutral buffered formalin. Place pinniped **claws** in 10 percent glycerine in 70 percent ethanol. **Skin** samples for DNA study are optimally placed in a formol-urea solution (example recipe below)<sup>60</sup>. If this cannot be obtained from a DNA laboratory or the ingredients are unavailable, tissue can be preserved in a saturated NaCl solution (with 5 percent DMSO if possible) or frozen at -20°C.

**Formol-urea solution:** 4M urea  
0.2M NaCl  
0.1M Tris-HCl, pH 8.0  
0.5 percent n-lauroylsarcosine  
10mM EDTA

In small animals, remove, weigh and preserve (in 10 percent neutral buffered formalin) the entire **reproductive tract and organs**. In all cases, preserve both ovaries and a sample of mammary tissue. Measure, weigh if possible, and preserve entire testes; repeat for epididymis. Collect baculum (penis bone). Slice large testes to ensure proper fixation. Measure, weigh, and determine the sex of the **fetus**.

Open the **stomach** carefully and gently flush the contents into a plastic bag. It may be necessary to scrape the mucosa to obtain the small but diagnostically important otoliths (ear bones of fish). Contents may include recognizable prey species, macerated flesh, skeletal fragments, otoliths— some so small as to be inapparent to the naked eye, numerous parasites, and a variable amount of fluid. (In cetaceans, the contents needed for dietary analysis are almost exclusively in the first stomach

chamber.) Collect and package the entire stomach contents of small animals, including non-food items. A representative sample may be all that is possible to collect from large animals. **Stomach content samples for life history studies can be frozen or preserved in 70 percent ethanol.** Be prepared to remove a subsample (whole fish, macerated flesh) for toxicology, and samples of parasites and lesions to satisfy other protocols (see 10.9, 10.11, 10.12).

#### **Ideal**

Obtaining complete samples for life history study is a realistic goal when the carcass quality permits it. There are usually enough stomach contents to meet the needs of other protocols.

#### **Practical**

A stomach full of food decomposes rapidly, leaving unmanageable foul-smelling fluid. Collecting and weighing stomach contents of large animals is an ordeal. When decomposition is advanced, reproductive organs may still be useful for determining sexual maturity (look for fetus or corpora albicantia; check size of testes). Obtaining teeth from large odontocetes requires an energetic approach with rugged tools, and dissecting earplugs demands considerable skill. Collection of life history samples from fresh carcasses may interfere with other procedures, e.g., samples of reproductive organs for histopathology or stomach contents for toxin analysis. In these circumstances, **investigators must agree on sampling priorities.**

#### **Precautions**

Establish sampling priorities. Once the stomach is open, contents including fluids and parasites will quickly contaminate other organs if they are not contained. **Do not preserve stomach contents of fish-eating species in formalin, since this may dissolve small bones.** Ovaries and testes should be packaged separately and labeled "left" or "right". Though perhaps obvious to the collector, it is wise to label the origin (position) of tooth samples. Teeth and gonads collected in a flurry of activity from many animals can easily be mislabeled and mismatched—with bizarre results.

## **10.9. Contaminants and Biotoxins**

### **Rationale**

Marine mammals are the potential ultimate repository for oceanic contaminants passed through the food chain. Stranded inshore residents provide information on regional conditions and trends. Offshore

species signal the extent to which the seas are being despoiled. Both groups reveal the influence of contaminants and toxins on health<sup>21,22,31,48</sup>. A commitment to collection and long-term storage of marine mammal tissues<sup>4,5</sup> will enable us to follow patterns of biological toxins, organochlorines, heavy metals and other contaminants, and to recognize the need for change and help guide future policy. **To be effective, the collection and preparation of specimens that form this resource must be impeccable, and the samples matched with reliable life history information.**

**Carcass selection:** Code 2 ideal; 1, 3 limited; 4, 5 useless.

Specimens from healthy, well-nourished animals are required to determine contaminant levels in normal populations. Biopsy samples for this purpose can be taken from skin and blubber. Samples from ill or emaciated individuals have limited value for determining trends but may elucidate the role of toxins and contaminants on health<sup>1,22</sup>.

Deterioration of tissues after death leads to change in contaminant load, with the extent of change depending on the tissue and the analyte involved. Samples for the National Biomonitoring Specimen Bank must be taken within 6 hours of documented death<sup>5</sup>. **Code 2** carcasses provide reliable samples for most other studies<sup>8</sup>.

### Sampling

A rigorous sampling protocol (Fig. 10.17) has been developed by the National Biomonitoring Specimen Bank (U.S. National Institute of Standards and Technology) and the Alaska Marine Mammal Tissue Project<sup>4,5</sup>.

**Blubber** and other body fats concentrate lipid-soluble organic contaminants. Blubber is always accessible and may be the only practical tissue to collect. Samples (300-400 g, about 10 cm square) include the full thickness of the layer, without skin or muscle (Fig. 10.18). Standardization of sampling sites<sup>5</sup> is suggested (Fig. 10.19) for more accurate cross-comparison purposes. Pinnipeds with thin blubber, e.g., fur seals, are sampled along the backbone, while those with thicker blubber are sampled in the sternal region. Two sites are recommended for cetaceans: one about 10 cm caudal to the blowhole and the other directly below the dorsal fin on the mid-lateral line<sup>62</sup>. Samples from manatees are taken from the outermost layer of blubber just to one side of the mid-ventral line<sup>6</sup>.

**Liver** accumulates all known organic and inorganic contaminants and some biotoxins. Collect the entire liver from small carcasses. For large ones, standardized sites are suggested<sup>5,6</sup>. Slice 300-400 g samples

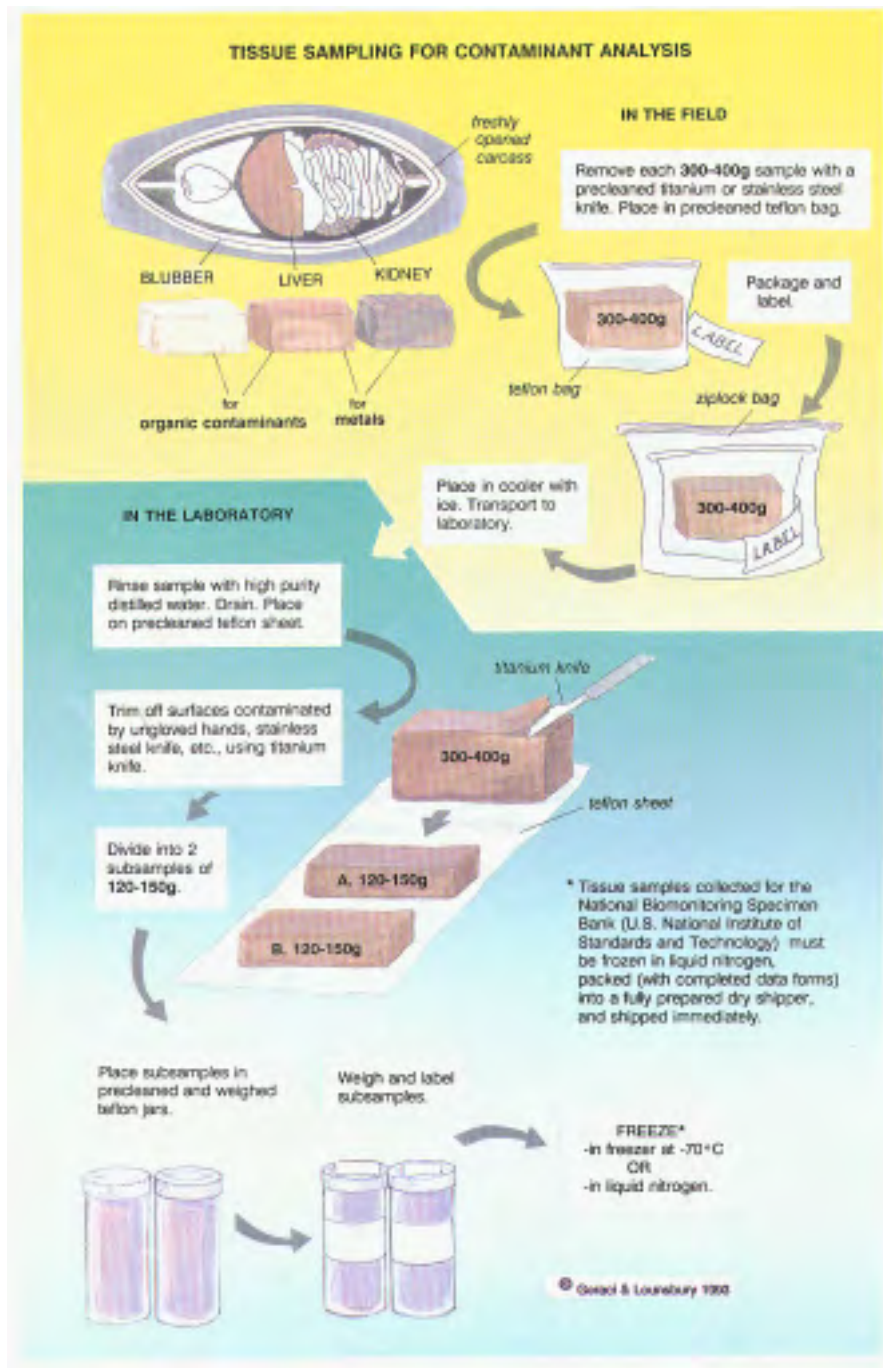
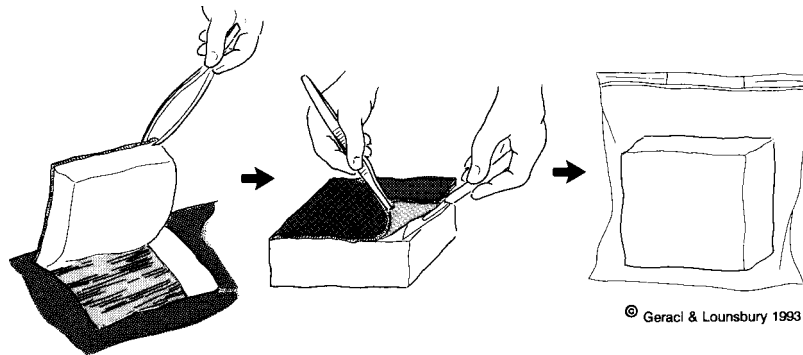


Fig. 10.17. Collecting tissue samples for toxicology.



**Fig. 10.18.** Correct procedure for collecting blubber samples, showing removal of skin and muscle.

(about 3/4 lb or grapefruit-sized) from the caudal part of the left anterior lobe of pinnipeds and left lobe of cetaceans (Fig. 10.19). The established protocol for manatees is to sample from the caudal tip of the right lobe<sup>6</sup>.

**Kidneys** concentrate metals. Take both kidneys from small animals, and, from large pinnipeds and cetaceans, the entire left kidney or a 300-400 g slice from the caudal end. Samples from manatees are taken in a similar fashion, but from the right kidney<sup>6</sup>.

**Brain** and **muscle** are often taken, but their value is questionable<sup>5</sup>. Brain decomposes quickly, and its removal from small animals requires skill and, in larger whales, more effort than resources usually allow. It is possible to measure changes in acetylcholinesterase resulting from exposure to short-lived pesticides and herbicides in brain tissue; for this purpose, it may be worthwhile to collect (and immediately freeze) the brain from small **Code 2** animals<sup>18</sup>. Indicate location in the brain from which any sample was taken.

Contaminant levels in muscle are low and procedures difficult to standardize. The epaxial muscles (over the back) are usually substantial in size and permit large samplings. Indicate the source of any muscle collected. Bone may be taken in cases of suspected long-term exposure to lead.

**Liver** and **blubber** samples of about 100 g (about 1/4 lb or hamburger-sized) and **stomach contents** are taken for **biotoxin analysis**. Collection, packaging and storage of samples<sup>2</sup> are illustrated in Fig. 10.20.

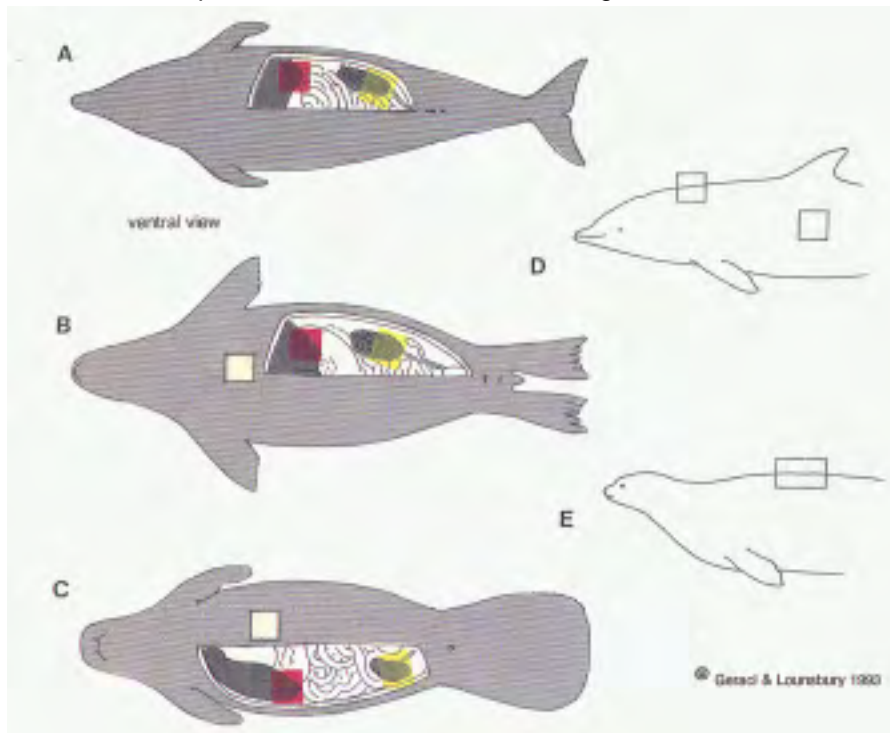
### Ideal

Under ideal circumstances, the fresh, intact carcass is sampled in a laboratory setting under sterile conditions. The National Biomonitoring

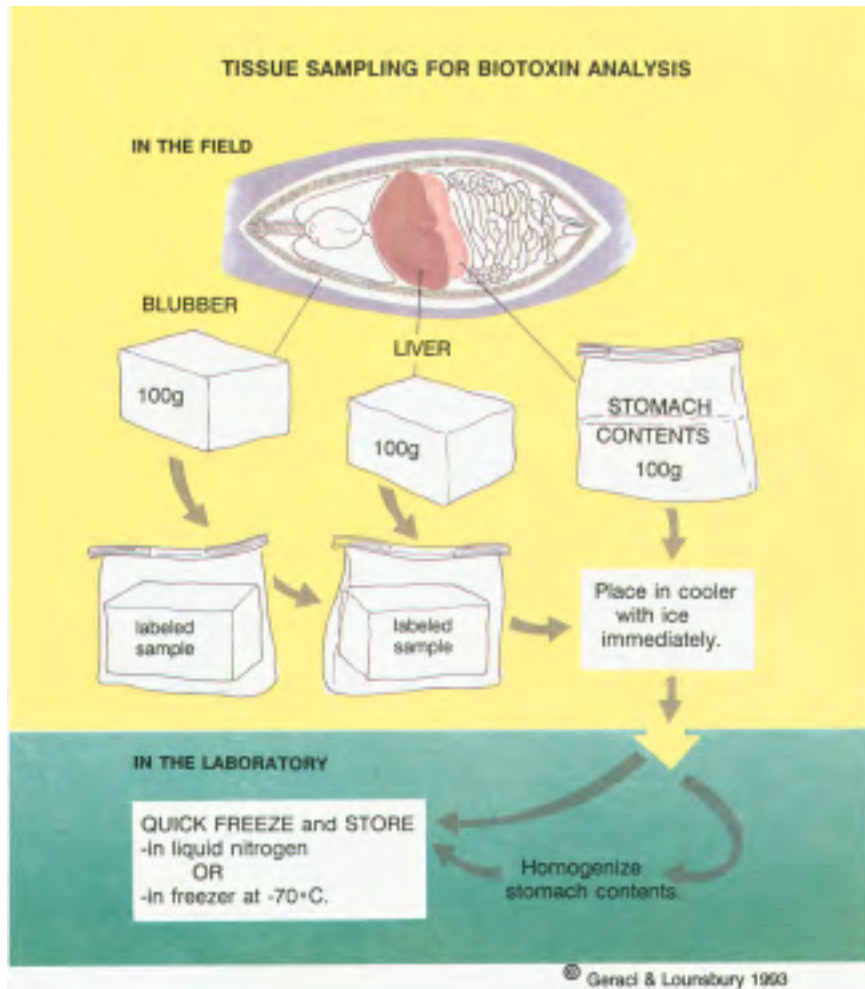
Specimen Bank protocol (Fig. 10.17) requires that the carcass be opened with **clean stainless steel instruments** and that personnel wear **talcum powder-free vinyl gloves**. Samples should be taken with a clean stainless steel or titanium knife (washed, rinsed with high purity water followed by ethanol, and air dried). Each sample should then be trimmed using a clean **titanium knife**, washed with high purity water, and cut into subsamples of suitable size for storage. Each subsample is placed in a pre-weighed **teflon jar** with a teflon-lined lid; the jar is labeled and weighed again. Containers are then refrigerated for immediate analysis or frozen at  $-70^{\circ}\text{C}$  or in liquid nitrogen for shipping or storage. At every stage of the procedure, care is taken to **avoid chemical contamination** of the tissues. All chemicals must be pesticide-free grade.

### Practical

Most carcasses will not be moved to a laboratory, though it is possible to construct a protective lean-to at the stranding site. Beach conditions



**Fig. 10.19.** Sites for collecting tissues for contaminant analysis. Sampling site for liver (**Red**) and kidney (**Yellow**) of cetaceans (**A**), pinnipeds (**B**), and manatees (**C**). Sampling site for blubber (**White**) of (**B**) robust pinnipeds, (**C**) manatees, (**D**) cetaceans, and (**E**) otariids and thin phocids.



**Fig. 10.20.** Collecting samples for biotoxin analysis.

are seldom sterile, and titanium knives, which dull easily, are not stock items. The rigorous sampling techniques demanded for tissue banking purposes require uncommon diligence and special training. Teflon jars, bulkier than the more available soft plastic packaging, and other special material add a measure of time, expense and inconvenience that a stranding team may not be in a position to handle.

When conditions are not ideal, remove a large slice (300-400 g minimum) of the required tissue as hygienically as possible from a fresh carcass. Record whether the knife is of ferrous metal or stainless steel. Package in teflon bags, seal with duct tape, and label with a waterproof

pen. Place samples in a cooler with blue ice and transport to the laboratory quickly. From this point on, it is imperative that the ideal protocol for preparing samples (above) is followed.

The National Biomonitoring Specimen Bank requires that samples for contaminant analysis be packaged in teflon bags and stored in teflon containers. Other studies accept the judicious use of alternate materials, such as borosilicate glass for organic analysis and the same or polyethylene for tissues for heavy metal analysis<sup>8</sup>. A common approach in the field is to collect oversize samples in aluminum foil, plastic bags or buckets, and transport them to the laboratory for later trimming. The samples must be kept cool and free of contamination by fluids or other tissues, and the trimming operation must follow within one to two hours.

### Precautions

**Analyses for contaminants are time-consuming and expensive.** Enthusiasm may lead to inappropriate sampling. Collection procedures are stringent and subtle modifying factors will creep in from the outset. **Specimens are easily contaminated** by precipitation, sea spray, sand, blood, bile and urine, tobacco smoke, exhaust fumes, insect repellents, soaps, oils, rusty tools, plastics and preservatives<sup>5,8</sup>. Carcasses are often moved to landfill sites for dissection, posing even greater risk of contamination. Competition for specimens can disrupt the protocol—for example, a stomach opened to remove parasites will release fluid onto the liver. Avoid sampling an organ in the region of ruptured membranes or previously cut surfaces. For organochlorines, sampling the leanest tissues first (e.g., muscle, kidney) will minimize contamination carried by fat to other tissues.

If packaged specimens from a fresh carcass are stuffed into a large container, they will continue to release enough heat and lytic enzymes to cause rapid decomposition of those in the center. **Pack loosely with liberal amounts of coolant interspersed among the samples.**

Persons must be properly trained in the use of liquid nitrogen and the containers in which it is shipped. Storage temperatures higher than -70°C may result in the decay of some organic compounds (e.g., DDT and BHC)<sup>8</sup>.

**Record any deviation from the protocol.**

## 10.10. Microbiology

### Rationale

A complete picture of the life history of any species includes an



evaluation of factors underlying natural mortality. Studies reveal that marine mammals harbor a variety of microorganisms, some of which are known to have pathogenic potential<sup>7,27,53</sup>. We now recognize that certain endemic diseases can periodically erupt into epidemics causing large-scale mortalities that have significant influence on the status of populations or stocks<sup>14,15,25,30,35,57</sup>.

**Carcass selection: Code 1, 2 ideal; 3 limited; 4, 5 useless.**

Even under ideal conditions, it is often difficult to associate bacteria isolated from a carcass with specific lesions<sup>36</sup>. Bacteria that are part of the normal flora may proliferate rapidly after death and may interfere with successful isolation of an offending pathogen. Any study on normal flora requires that only the freshest, uncontaminated specimens be used. Bacteria associated with active infectious processes tend to endure longer in viable concentrations, and certain species may be isolated from more deteriorated carcasses, even frozen stored specimens (**Code 3**).

Most viruses are fragile and have a short life span in decomposing tissue. Viruses that persist long enough to be harvested and identified, however, are generally responsible for some infectious process. Some, such as the influenza virus in seals, can be cultured and remain infective in both decomposing and frozen carcasses<sup>59</sup>.

### Sampling

Sample selection for bacteriology and virology is determined largely by the nature of the gross pathologic findings. Refer to Figs. 10.21 and 10.22 for sampling protocols.

**Samples should be taken aseptically**, first from external surfaces and then from body cavities and internal organs as soon as they are exposed. The core of a fleshy or hollow organ or fluid-filled lesion (e.g., abscess) is sampled by inserting a swab in an incision made through the sterile surface, prepared by searing (Fig. 10.23) or disinfected with 10 percent formalin or 70 percent ethanol and allowed to dry. Fluid samples from a cavity are taken by aspiration (through a sterile surface) before or moments after opening. Tissues destined for laboratory sampling (sear-sampling, cultures, impression smears) should be large enough (about 6x6x6 cm) to allow for trimming and must have one capsular or serosal surface intact.

Take separate samples for bacteriology and virology, and freeze additional tissues for later use. Large lesions are sampled from two or three distinct regions. Bone marrow remains uncontaminated longer



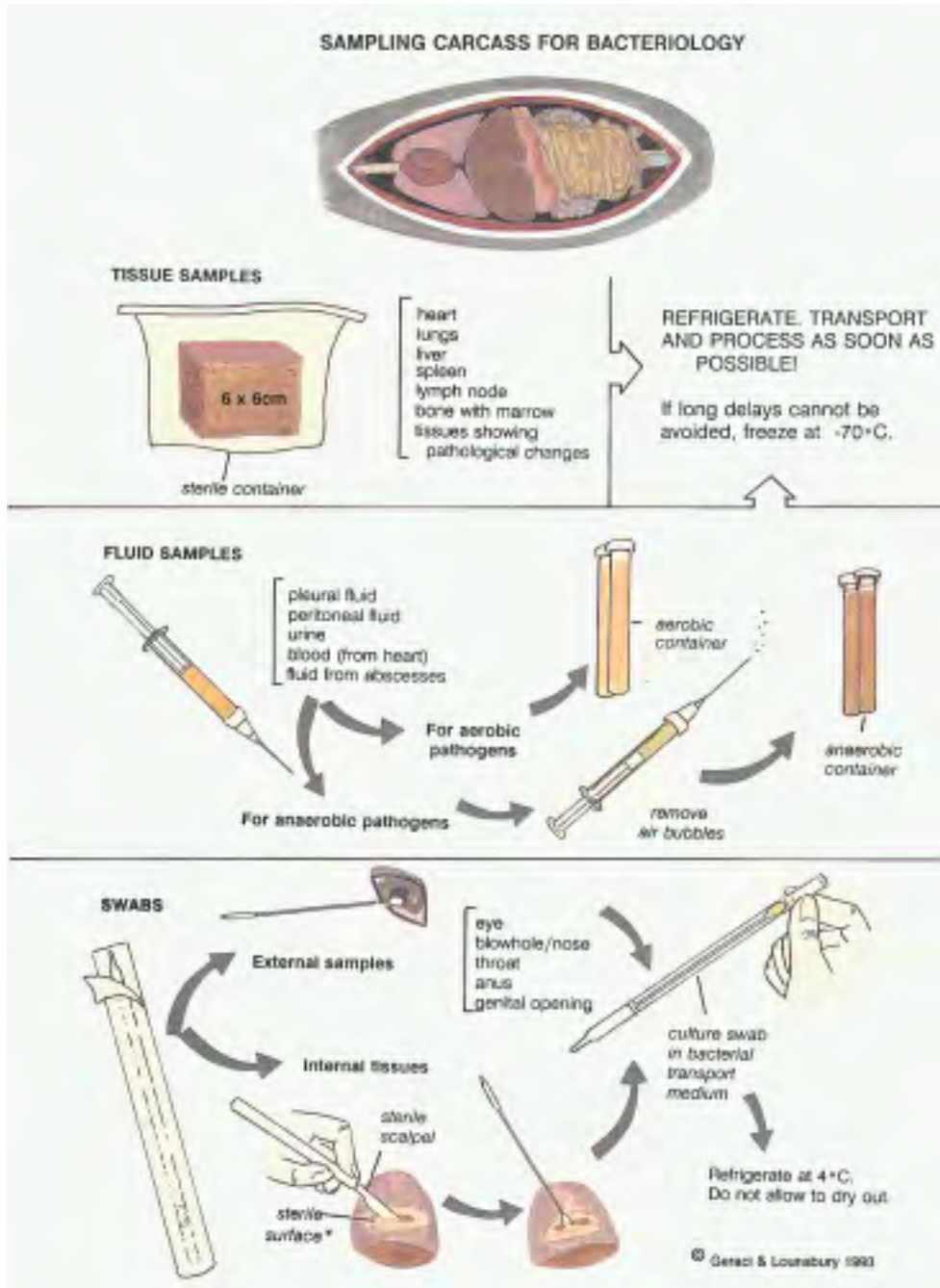


Fig. 10.21. Collecting samples for bacteriology.

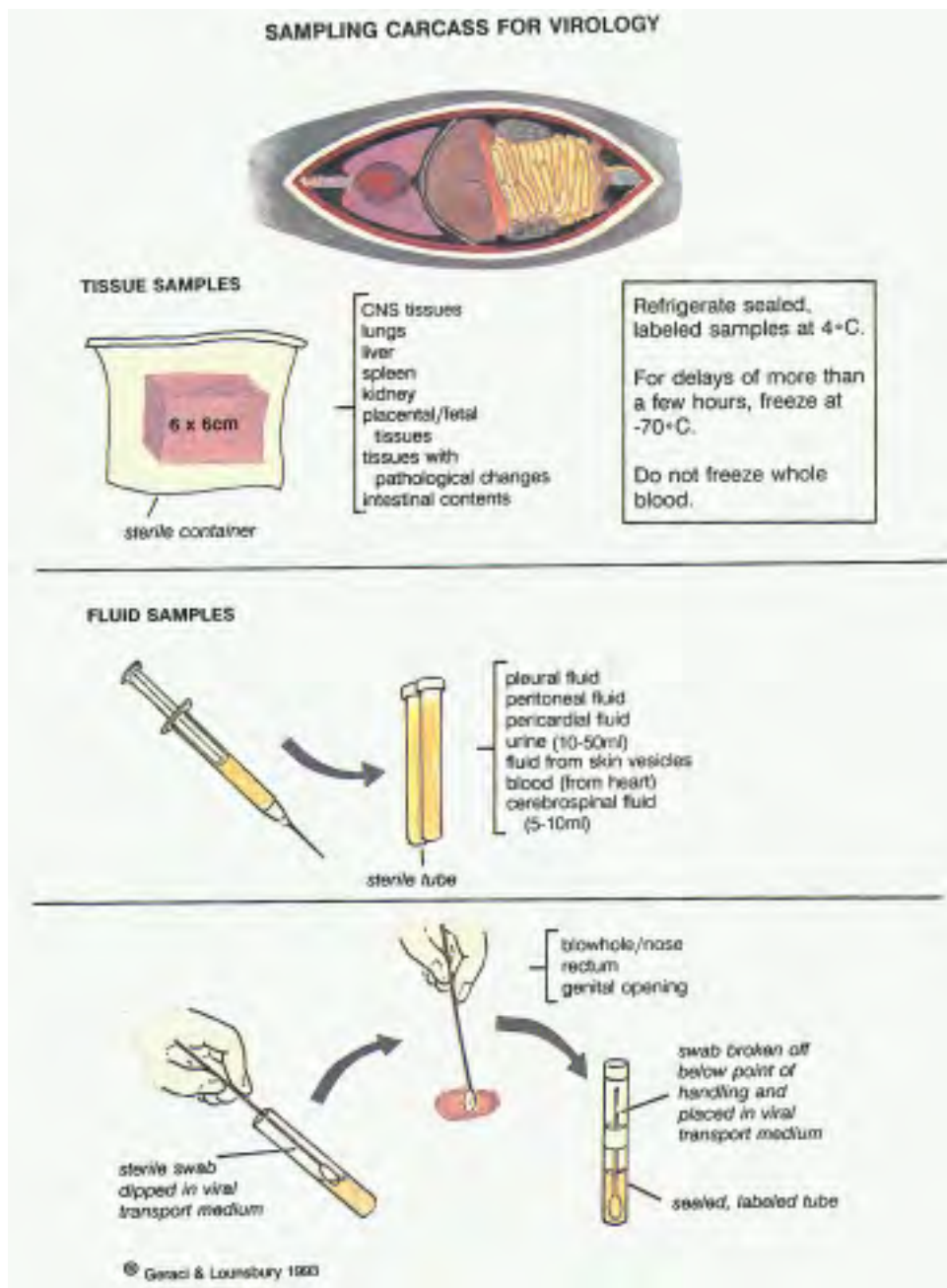
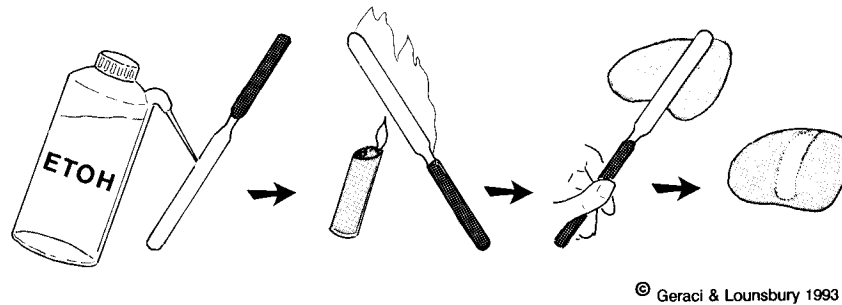


Fig. 10.22. Collecting samples for virology.



© Geraci &amp; Lounsbury 1993

**Fig. 10.23.** Sterilizing tissue surface by searing.

than other tissues<sup>9</sup> and may, in some species, be worth sampling when carcass quality is questionable. Standard procedures<sup>10</sup> are used to obtain samples from the femur in pinnipeds; an incision through the skin is required. In cetaceans, sampling from the 5th to 8th vertebral bodies anterior to the flukes is recommended<sup>56</sup>. If biopsy needles are unavailable, collect and submit the entire bone to the laboratory.

Place swabs in the appropriate transport medium (generally available from diagnostic laboratories) (Figs. 10.21, 10.22). Aspirated pus from abscesses and other lesions where anaerobic organisms are suspected should be transported in anaerobic vessels. Package tissues in sealed, sterile leak-proof bags or jars. Label, cool and transport to the laboratory immediately. **Avoid freezing samples for bacteriology**, but if long delays are unavoidable, freezing at  $-70^{\circ}\text{C}$  is preferable to decomposition<sup>37</sup>. Record conditions of collection and storage.

Fecal samples that cannot be cultured immediately can be placed in a stool preservative (equal volumes of 0.033 M phosphate buffer and glycerol) to prevent changes in pH<sup>36</sup>.

Material taken for examination of mycotic agents (usually from the skin) is obtained by scraping with a scalpel blade and/or by removing a number of hairs from the affected area. The samples should be refrigerated until they can be inoculated onto a suitable growth medium<sup>17</sup>.

### **Ideal**

All equipment required for sampling tissues for viruses, bacteria, and mycotic organisms is available in the field kit. Fresh transport media has been obtained. Collection protocols are strictly followed by trained individuals. Immediate transportation to the analytical laboratory has been arranged in advance. The laboratory has been involved in the planning and is prepared to receive and process all samples.

### Practical

Sampling for microbiological testing is worth the time and effort required only when the tissue is in suitable condition, the necessary equipment is available, and all arrangements have been made for transportation and processing. **There is little latitude between the ideal and the practical approach.**

### Precautions

Discard samples suspected of being contaminated, including swabs that have contacted anything other than the intended fluid or tissue. Do not allow specimens to dry out. Do not sample internal organs once the gut has been opened. Team members must wear gloves and protect exposed skin, mucous membranes and eyes from contact with carcass material.

## 10.11. Gross and Histopathology

### Rationale

Carcasses are a biological record of illnesses endemic in populations, diseases and disorders underlying natural mortality, and conditions that might have led the animal to strand. The information is tapped by careful selection of tissue samples for pathology studies.

### Carcass selection:

Gross: **Code 2, 3** ideal; **4** limited; 1, 5 useless.

Histopathology: **Code 2** ideal; **3** limited; 1, 4, 5 useless.

Injuries such as fractures and lacerations remain evident for long periods of time, as do certain firm lesions (e.g., tumors). Carcasses too decomposed for histopathology may still be useful for describing gross pathologic conditions. Brain, spleen, liver, and other enzyme-rich organs are the first to deteriorate<sup>9</sup>.

### Sampling

The carcass should be examined systematically (*see 10.5*) and samples taken from any areas with visible lesions or suspected pathologic change (Fig. 10.24); samples should also be taken from lymph nodes that drain the site. **Because all pathologic conditions cannot be judged grossly, we suggest taking samples from all organs, even those that appear normal.**

A specimen should encompass normal and abnormal tissue and the transitional area between (Fig. 10.25). It must be thin enough to allow penetration of the preservative (i.e., less than 1 cm thick—preferably about 5 mm). Make numerous parallel cuts in any thicker piece of tissue to permit adequate preservation.

Tissues are preserved in **10 percent neutral buffered formalin**, prepared by mixing 90 mL water, 10 mL 37 percent formaldehyde, and 2 g sodium acetate. Use a minimum ratio of 10 volumes of preservative to 1 volume tissue. Samples for electron microscopy are finely diced and placed in glutaraldehyde fixative. Place samples in watertight glass jars, plastic containers or bags.

### Ideal

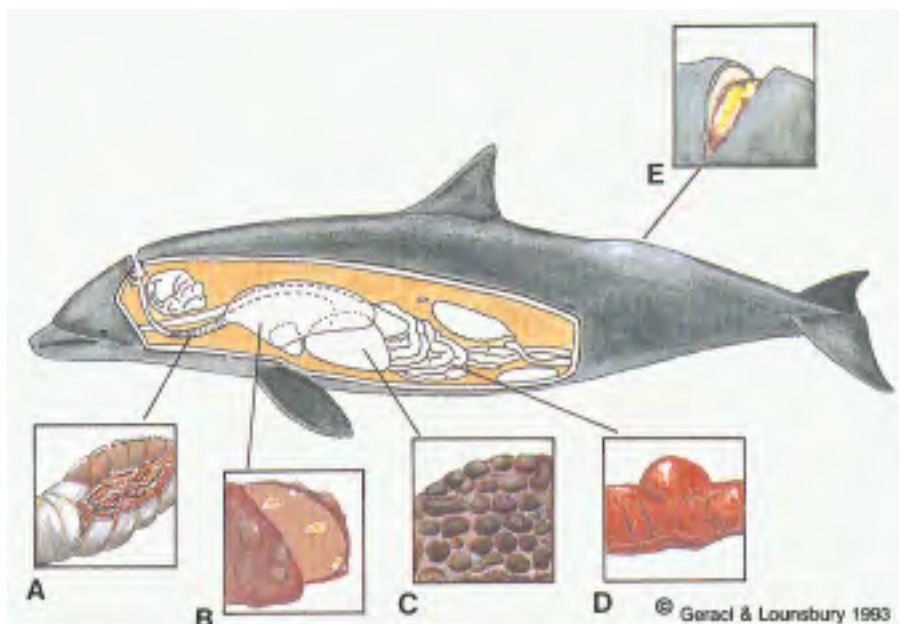
Fresh carcasses should be thoroughly examined in clean surroundings by equipped, trained personnel. Lesions are described and, if unusual, illustrated or photographed. Representative samples from each are collected, properly trimmed, and immediately placed into clean containers with preservative of appropriate strength and volume. Jars are labeled inside and out. A record of samples taken is included on the data form.

### Practical

In the field, the depth of the examination is limited by the quality of the specimen, environmental conditions, and team experience. Except under severe weather conditions or failing light, a pathologic study on a single animal can be carried out in its entirety. Complete examination of every carcass is difficult to accomplish in a mass stranding. Select a few

*"I've got those  
tissue samples you've  
been waiting for!"*





**Fig. 10.24.** The internal examination: examples of pathologic conditions and their description. A. Trachea: a tangled mass of nematodes (worms) partially obstructs the trachea. B. Lung: the lung contains a number of abscesses filled with cottage cheese-like exudate, under the surface and throughout the organ. C. Liver: the liver surface is cobbled because of a mixture of scarring (the depressions) and regeneration (the nodules). D. Gut: a smooth nodule (probably a tumor) protrudes from the external surface of the intestine. E. Back: incision of a swelling visible on the back behind the dorsal fin reveals a mixture of pus and blood in the blubber and underlying muscle. (Descriptions courtesy of B. Wilcock, Ontario Veterinary College, University of Guelph, Guelph, Ont.)

specimens for a full initial study, and identify conditions to look for in a targeted survey of the remaining animals.

#### Precautions

**Thick tissues packed in a jar will rot.** Pay attention to sample size and the proportion of preservative. Frozen tissues tend to liquify when they thaw and are unacceptable for histopathology.

### 10.12. Parasitology

#### Rationale

Virtually every marine mammal carcass has parasites. Most of these are innocuous and have value as ecological markers. Others, however, may cause serious illness to individuals and, perhaps, ultimately affect populations<sup>26,45</sup>.



Fig. 10.25. Collecting tissues for histopathologic examination.



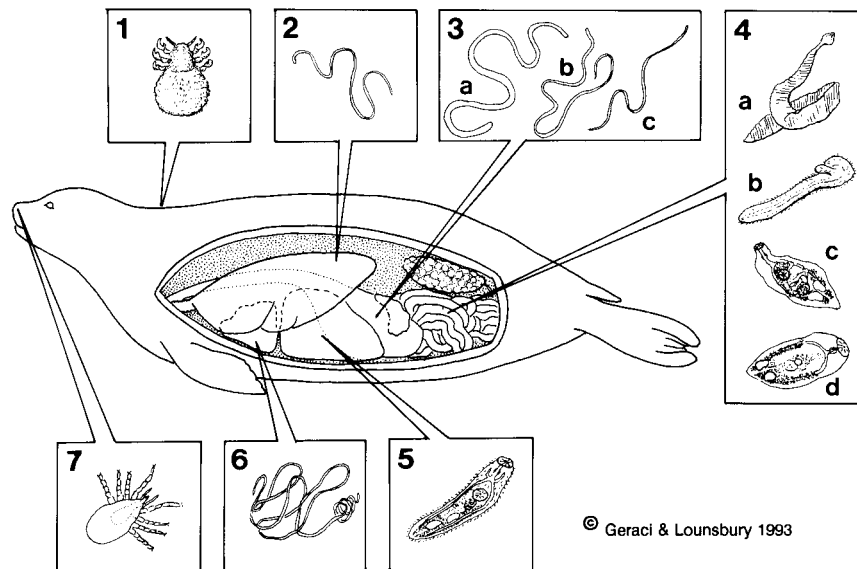
**Carcass selection: Code 2, 3 ideal; 1, 4 limited; 5 useless.**

**Examination for parasites is practical as long as the carcass is suitable for pathologic investigation.**

### Sampling

Parasites in marine mammals occur in predictable sites (Figs. 10.26-10.31) that can be mapped after examining a few carcasses. Collect and preserve samples of loose parasites. Some, such as lungworms, and *Crassicauda* in mammary tissue, are difficult to remove intact. These and other embedded parasites should be taken with a section of infected tissue for later identification. Cestode specimens must include the head to allow for proper identification.

A variety of methods are used to preserve parasites<sup>6,46,54</sup>. Alcohol-formalin-acetic acid, or AFA (formula on page 221), is a simple and practical fixative for both dead and live endoparasites (Fig. 10.32)<sup>23,46</sup>. Ectoparasites can be fixed in 5 percent glycerin in 70 percent ethanol, and algae in 5 percent neutral buffered formalin<sup>6</sup>.



© Geraci & Lounsbury 1993

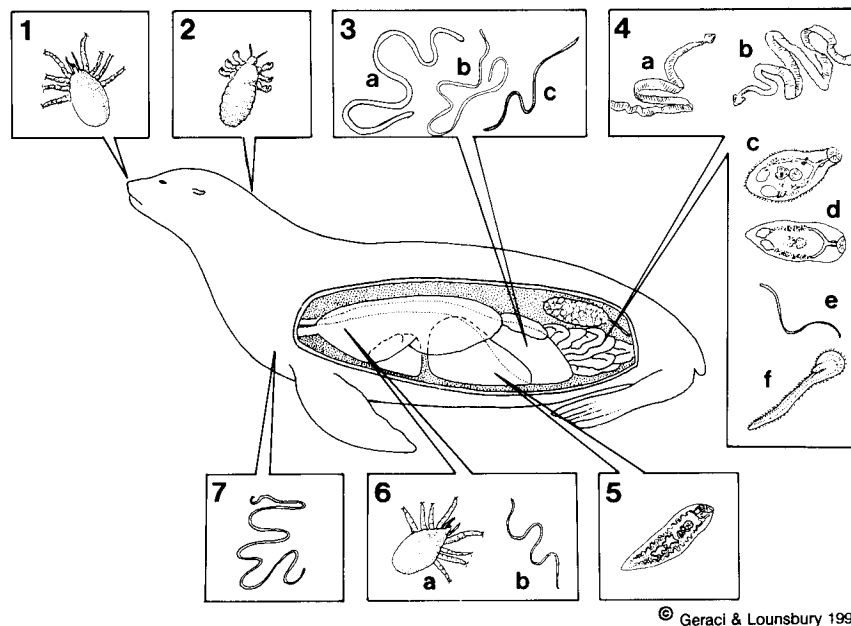
**Fig. 10.26.** Some parasites of phocids in North American waters<sup>11,13,38,39</sup>. **1. Skin:** *Echinophthirius horridus* (2-4 mm). **2. Lungs:** *Otostrongylus circumlitus* (50-70 mm). **3. Stomach:** **a,** *Anisakis similis* (>60 mm); **b,** *Terranova decipiens* (40-70 mm); **c,** *Contraecaecum osculatum* (<60 mm). **4. Intestines:** **a,** *Diphyllbothrium* sp. (*D. lanceolatum*, 45-55 mm); **b,** *Corynosoma* sp. (3-6 mm); **c,** *Phocitrema fusiforme* (1-1.5 mm); **d,** *Cryptocotyle lingua* (0.5-2 mm). **5. Liver, gall bladder, bile and pancreatic ducts:** *Orthosplanchnus* sp. (<20 mm). **6. Heart:** *Dipetalonema spirocauda* (140 mm). **7. Nasopharynx:** *Halarachne* sp. (1 mm).

**AFA Solution:** 100 mL formaldehyde (37-40 percent)  
 400 mL distilled water  
 500 mL ethanol (100 percent)  
 20 mL glacial acetic acid

Fix feces for parasite examination in an equal volume of hot 10 percent formalin if possible; transfer later to 70 percent ethanol<sup>64</sup>.

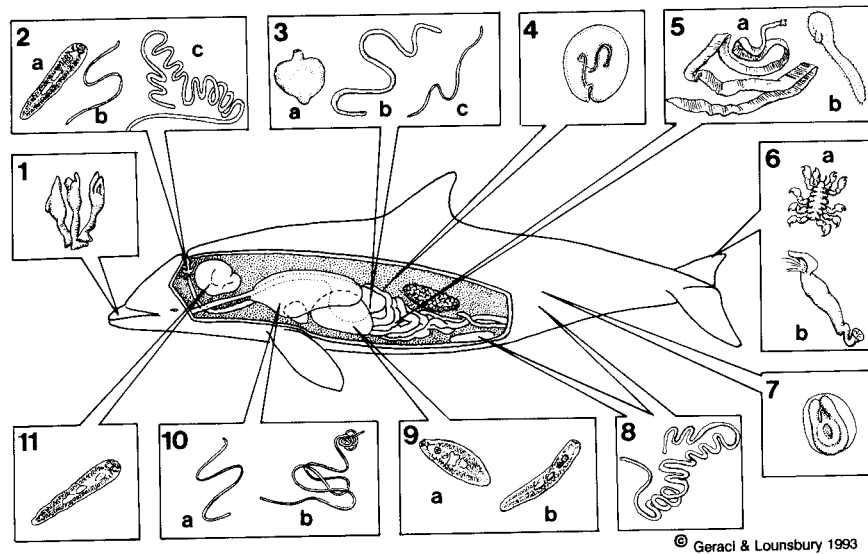
### Ideal

All parasites are collected intact for identification and counting, along with samples of associated infected tissue. Location and density are recorded and the lesions photographed. Samples are fixed in appropriate medium and labeled with animal identification number and site of origin.



© Geraci & Lounsbury 1993

**Fig. 10.27.** Some parasites of otariids in North American waters<sup>1,13,38,39</sup>. **1. Nasopharynx:** *Orthohalarachne* sp. (0.6-5 mm). **2. Skin:** *Antarctophthirius* sp. (2-4 mm). **3. Stomach:** a, *Anisakis similis* (>60 mm); b, *Terranova decipiens* (40-70 mm); c, *Contracaecum osculatum* (<60 mm). **4. Intestine:** a, *Diphyllobothrium* sp. (*D. pacificum*, 100-250 mm); b, *Diplogonoporus* sp. (>500 mm); c, *Pricetrema zalophi* (<0.5 mm); d, *Cryptocotyle jejuna* (0.5-2 mm); e, *Uncinaria* sp. (8-16 mm); f, *Corynosoma* sp. (3-8 mm). **5. Liver, gall bladder and bile ducts** *Zalophotrema hepaticum* (10-15 mm). **6. Lungs and trachea** a, *Orthohalarachne* sp. (0.6-0.8 mm); b, *Parafilaroides* sp. (<25 mm). **7. Muscle and fascia** *Dipetalonema odendhali* (55-120 mm).



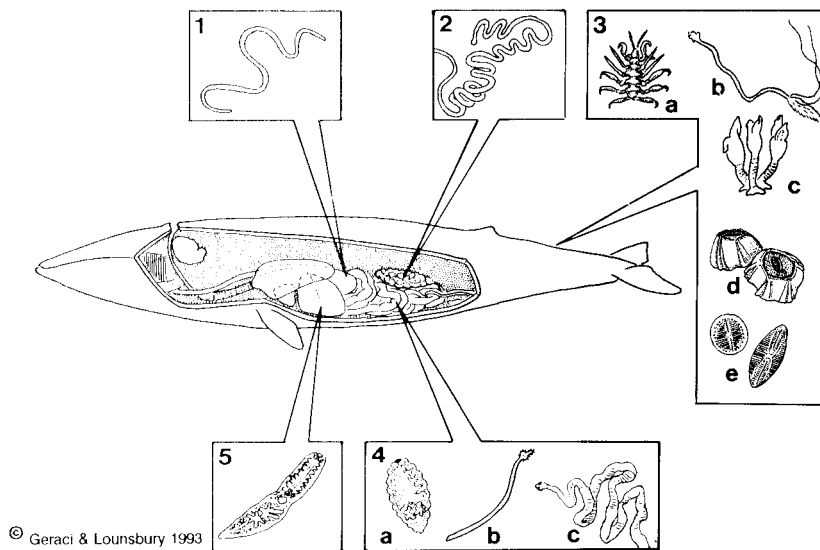
**Fig. 10.28.** Some parasites of toothed whales in North American waters<sup>41,13,38,39</sup>. **1. Teeth:** *Conchoderma* sp. (<15 cm). **2. Cranial sinuses:** **a,** *Nasitrema* sp. (10-35 mm); **b,** *Stenurus* sp. (20-50 mm); **c,** *Crassicauda* sp. (>500 mm). **3. Stomach:** **a,** *Braunina cordiformis* (4-9 mm); **b,** *Anisakis* sp. (>60 mm); **c,** *Contracaecum* sp. (<60 mm). **4. Abdominal cavity and mesentery:** *Monorygma grimaldiploerocercoid* cyst (20-30 mm). **5. Intestine:** **a,** *Tetrabothrium fosteri* (25-65 mm); **b,** *Corynosoma* sp. (3-6 mm). **6. Skin:** **a,** *Syncyamis* sp. (2-7 mm); **b,** *Xenobalanus* sp. (<50 mm). **7. Blubber:** *Phyllobothrium delphiniploerocercoid* cyst (4-9 mm). **8. Mammary glands, muscle and fascia:** *Crassicauda* sp. (>500 mm). **9. Liver, pancreas and bile ducts:** **a,** *Campula oblonga* (3-6 mm); **b,** *Oschmarinella* sp. (30-35 mm). **10. Lungs and trachea:** **a,** *Stenurus* sp. (20-50 mm); **b,** *Halocercus* sp. (17-80 mm). **11. Brain:** *Nasitrema* sp. (10-35 mm).

### Practical

Collecting parasites is simple and straightforward but requires patience. A representative sample of generally intact parasites with samples of infected tissue, properly fixed and labeled, is a realistic goal.

### Precautions

Parasites must be removed carefully, as they may be fragile and firmly attached to the host tissue. Seal lice survive for some time on a carcass and can be transferred via clothing to seals in captivity.

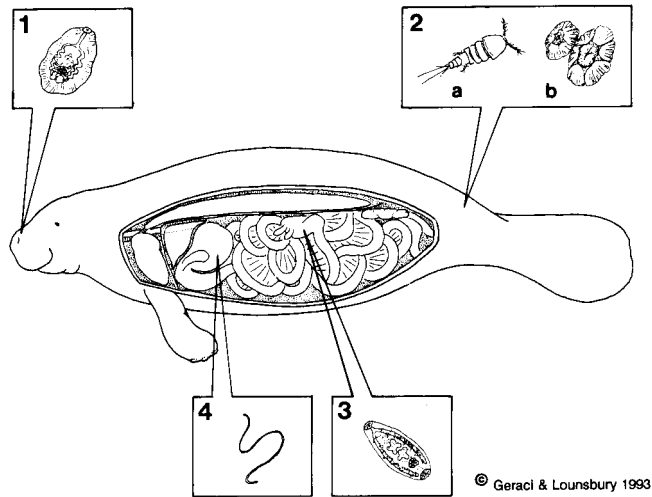


**Fig. 10.29.** Some parasites of baleen whales in North American waters<sup>11,13,38,39</sup>. **1. Stomach:** *Anisakis* sp. (>60 mm). **2. Urogenital tract:** *Crassicauda* sp. (>500 mm). **3. Skin:** a, *Cyamis* sp. (10-30 mm); b, *Penella balaenopterae* (300 mm); c, *Conchoderma* sp. (<15 cm); d, *Coronula* sp. (<50 mm); e, diatoms (*Navicola* sp., *Cocconeis ceticola*). **4. Intestine:** a, *Ogmogaster plicatus* (6-14 mm); b, *Bolbosoma* sp. (35-100 mm); c, *Diplogonoporus* sp. (>500 mm). **5. Bile ducts:** *Lecithodesmus goliath* (70-90 mm).

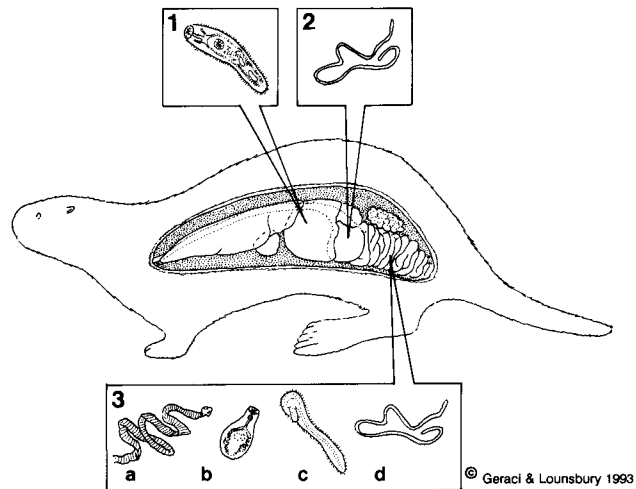
### 10.13. Samples for Skeletal Preparations

While photographs and measurements can document the specific identification of some animals, skulls and skeletons can do it much better. In addition, osteological material provides a means of determining physical maturity of a specimen and may document skeletal abnormalities or injuries.

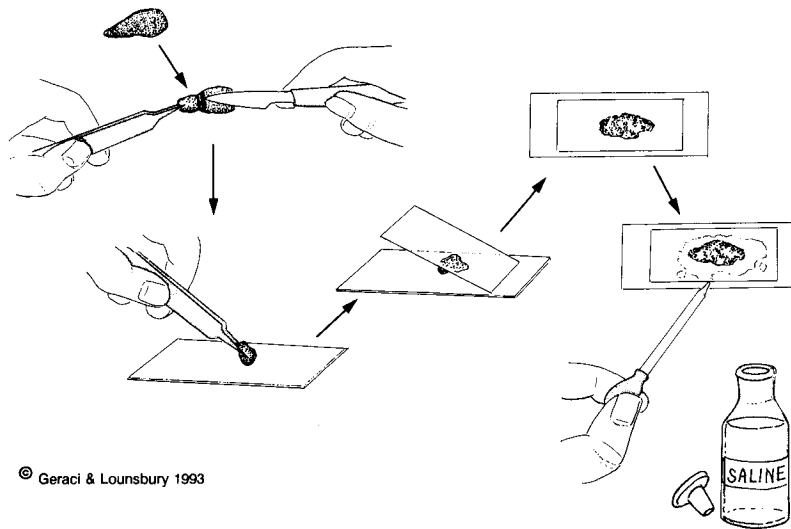
The skeleton of a small specimen is best prepared in the laboratory from the intact carcass of an adult animal. Larger animals can be cut into sections (disarticulated), with each piece labeled, and transported in a leak-proof container. A large, cumbersome carcass can be buried at the site, deep enough to prevent disturbance and reduce risk to public health, and retrieved months or years later. Skeletons can also be prepared by composting a carcass in manure, or by placing it inside a cage with 0.5 cm holes and sinking it in the ocean for cleaning by amphipods.



**Fig. 10.30.** Parasites of the West Indian manatee<sup>6</sup>. **1. Nasal passages and bronchi:** *Cochleotrema cochleotrema* (7-10 mm). **2. Skin:** **a**, *Harpacticus pulex*; **b**, barnacles. **3. Intestine and caecum:** *Chiorchis fabaceus* (10 mm). **4. Stomach:** *Heterocheilus tunicatus* (30-35 mm).



**Fig. 10.31.** Parasites of the sea otter in North American waters<sup>13,47</sup>. **1. Gall bladder:** *Orthosplanchnus fraterculus* (<20 mm). **2. Stomach:** *Terranova decipiens* (<60 mm). **3. Intestine:** **a**, *Diplogonoporus tetrapterus* (>500 mm); **b**, *Microphallus pirum* (<0.5 mm); **c**, *Corynosoma* sp. (5-18 mm); **d**, *Terranova decipiens* (<60 mm).



**Fig. 10.32.** Crush-smears of cetacean brain and mammary tissue may show presence of parasite ova.

## 10.14. Packaging and Shipping

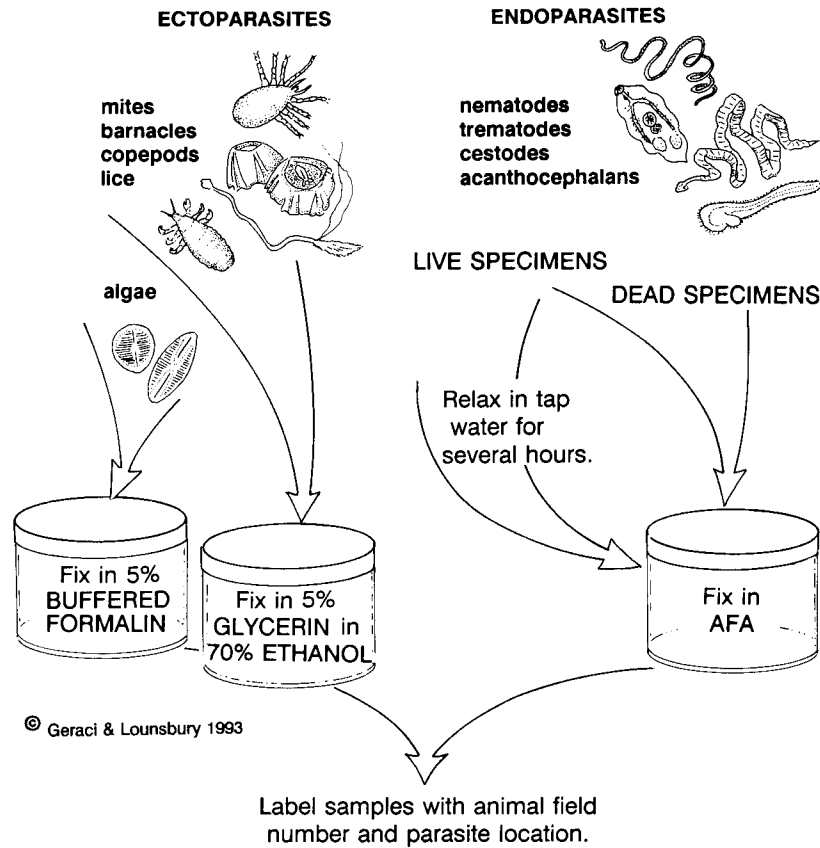
### Packaging and Labeling

Package each specimen to comply with the appropriate protocol. Label clearly with indelible ink. Preferably “double-bag” (i.e., bag within a bag) tissue samples, placing a waterproof (and oilproof) label in each bag. Samples for contaminant analysis are exceptions; no label should come into contact with the tissues. Jars with preserved materials should be labeled on the outside but also contain a duplicate label inside. Do not label lids only, as they can be inadvertently switched. Secure tags directly to voucher specimens such as skulls or mandibles; tag large items (e.g., skulls) in more than one location.

#### Include on the label:

- animal identification number
- species
- date and time (mm/dd/yy/military time) and location
- tissue

## PARASITE SAMPLING

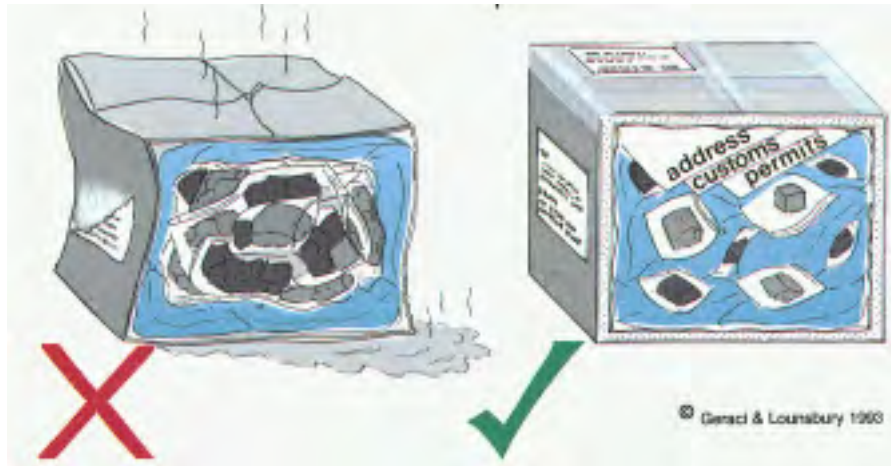


**Fig. 10.33.** Collecting parasite samples.

### Shipping

Shipping containers must be sturdy. Clearly print name, address and telephone numbers of both the shipper and receiver. Place a duplicate address label inside, along with all required documentation (i.e., loan form, permits and customs documents). Enclose a copy of the stranding report form to provide pertinent information on species, size, sex and observed pathologic conditions. Arrange for pick-up at destination before shipping perishable specimens.

Pack samples in a manner to prevent loss, crushing or deterioration and to protect persons involved in subsequent handling. Clean all surfaces of harmful substances (e.g., formalin).



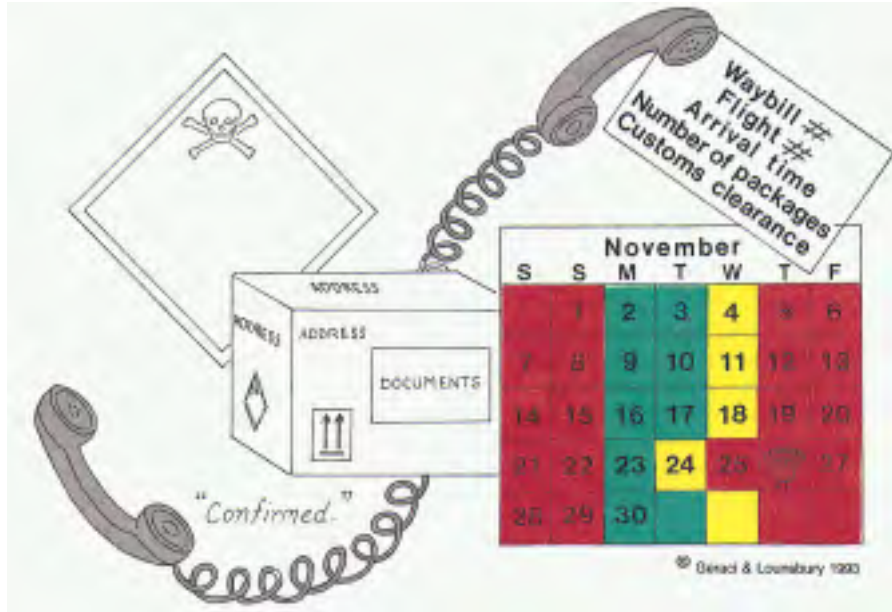
**Fig. 10.34.** Proper packaging is essential to protect frozen specimens. Use a well insulated container with liberal amounts of blue or dry ice interspersed among the tissues.

Bone specimens can be wrapped in protective paper or plastic, and packed in styrofoam chips. Fixed tissues are rinsed with distilled water or fresh preservative, wrapped in cheesecloth or gauze, moistened with preservative, and double-bagged. Pack perishable samples in a sturdy ice chest with ample amounts of blue or dry ice interspersed among specimens (Fig. 10.34). Arrange rapid transport (i.e., courier or air express). Be aware of current airline regulations concerning biological and hazardous substances (e.g., formalin) and restricted coolants (e.g., dry ice). Make arrangements for obtaining necessary forms, labels and documentation before taking material to the shipper.

#### Precautions

Samples arriving at their destination without positive identification and documentation are useless, as are those that become decomposed or contaminated by inadequate or improper packaging. Consider the day of the week specimens will arrive at their destination before shipping (Fig. 10.35), planning so parcels arrive when they can be unpacked immediately— **this is essential for frozen tissue**. Clearly indicate on the package the day and night telephone numbers of the recipient. When traveling by air, try to arrange direct flights, avoid airports where long delays are common, and, if possible, package specimens in small carry-on containers. Days of toil have been lost by samples gone astray with errant luggage.





**Fig. 10.35.** Perishable samples are best shipped by express overnight delivery service. Avoid weekends and holidays, and call ahead to inform the recipient of shipping details. **Be sure that all necessary permits and documents accompany the shipment.**

*Chapter 11*  
**Carcass Disposal**

11.1. Let It Lie .....	229
11.2. Bury It. ....	231
11.3. Move It .....	232
11.4. Tow It Out to Sea .....	234
11.5. Render It .....	235
11.6. Blow It Up .....	235
11.7. Burn It. ....	236
11.8. Afterward .....	237
11.9. Conclusion .....	237
References .....	284

*“That whale is here. We have seen him and smelled him. We are wiser for it, because we have had a ‘most practical lesson in natural history’..The whale is composed of several parts...There is the blubber, and the whalebone and—the smell. The latter seems to be the most prominent feature of this whale.”<sup>15</sup>*

The simplest way for a carcass to disappear is to turn your back on it and walk away. That approach is fine in remote areas, but what if the scene is a bathing beach or someone’s backyard? Soon after the novelty wears off, all but the most resolute scientist will be clamoring for the carcass to vanish. Who is responsible for it then? Maybe the community or homeowner at first. But as we all learn sooner or later, the local attitude is, “you cut it, you own it”, and the stranding team may find itself burdened with the fragrant remains. How the team accomplishes the task of disposal will depend on circumstances. Here are some often-attempted, but not always successful ways of getting the job done, presented with the help of colleagues who have recounted for us some of their best and worst experiences.

**11.1. Let It Lie**

Leave it where it is and let weather, tide and scavengers do the work. This is a common practice in uninhabited areas where there is no concern about a smelly mess or public health hazard. The process is fast; even massive carcasses decompose quickly. Eight mature hump-back whales left exposed on the tidal flats of Cape Cod after a December 1987 stranding were reduced to inconsequential remains by summer.

The process can be accelerated by predatory sightseers. Peter Best<sup>2</sup>, from South Africa, reminds us that in some parts of the world a carcass, for all its scientific value, is still a good source of food.

*"A straggler from a mass stranding of Risso's dolphins was left rolling in the surf while rescue teams struggled elsewhere with the main body of the animals. Returning six hours later, all that could be found was one flipper and a skull minus the lower jaw, still attached to a spotlessly cleaned portion of the rib cage".*

Before the Marine Mammal Protection Act, some folks in the United States also utilized stranded animals to supplement their lean larders. That was Bill Perrin's<sup>12</sup> response to a nude bather's desire to know if the meat from a whale he was examining was safe "for her dog." "Good," she said as she, together with her unclad husband, piled 50 pounds or so onto a piece of plywood. Bill recalls "the board was limber and the meat bounced... everything bounced."

Such wholesale enterprise is less likely today. Still, before turning away from the carcass, extract tusks and teeth to protect any souvenir hunter from unknowingly running afoul of the law. Also open the abdomen and thorax. For one thing, it will prevent any bloater decomposing in the hot sun from becoming the subject of another messy explosion story. And be careful when cutting. Bob Bonde<sup>3</sup> tells us about a salvage worker who was stripping back the skin of a 50-foot sperm whale...

*"The fellow was standing on the carcass making cuts with a 6 foot Norwegian flensing knife when he disappeared. A 'splosh' was heard, then muffled cries for help. His mates ran around the whale, but alas could not find their friend. Finally, a gooey, dripping mess emerged covered from head to toe in oil; the fellow had fallen entirely into the massive junk case in the whale's head. He said it took two weeks to purge himself of the smell, but his close friends, noses hoisted, confess he's never completely gotten rid of it."*

Another reason for opening a carcass is so that it will sink in the event the surf steals it back to the sea. A bloated whale floats high on its back, the dorsal fin acting like a keel, as it sails before the wind like a 10-meter yacht. These "floaters," as they are called, cause endless confusion as they are rediscovered, renumbered, and relocated. Michael Bigg (as told by Tom Smith<sup>14</sup>) bolted into action at the resighting of a floating killer whale that turned out to be an unfinned and hairy Holstein cow. And while people were contemplating a course of action for a huge fin whale that had washed ashore near Kennebunkport Harbor, Maine, in 1991, a

hurricane two weeks later propelled the whale across Whale Cove a kilometer away to Walker's Point, the home of Kennebunkport's famous summer son, former President George Bush.

It is amazing how long a carcass can continue touring the beaches. Jim Mead<sup>9</sup> and one of the authors (Geraci) once responded to the stranding of a 10-meter long right whale on Monomoy Island, Cape Cod, that had already lost most of the epidermis through decay. The carcass answered the first incision with a gush of liquid innards; the afternoon tide then carried the remains back to sea. Jim's logbook tells the rest of the story...

*"Five weeks later, I responded to a call about a whale hung up on an offshore rock near Buzzards' Bay, on the Cape. We managed to get out to it by rowboat and lo and behold, it was the Monomoy right whale, which in 5 weeks had drifted 15 miles to the west. In the meantime, it had lost all of its flesh and bones and what we had before us was just a blubber blanket.*

*Two days later, the blubber departed and made its way to Craigville Beach, a popular bathing resort. Details of the ultimate disposal (at sea) are lacking because the fisheries agent involved turned out to have spent some time on a submerged rock when the police launch in which he was riding sunk."*

Do small pieces decompose sooner than whole animals? Greg Early<sup>5</sup> and Bob Prescott had some unexpected results, in a winter marsh setting at least. Hoping to minimize any ecological damage caused by large carcasses, they scattered small cut sections from 60 pilot whales over a large area of bog and sunk the heads deep into salt-marsh pools. About a dozen carcasses were simply opened and left alone. By spring the intact carcasses had virtually decomposed, and the underlying marsh grass was well on its way to recovery. Meanwhile, the scattered sections had polluted the pools and spoiled the surrounding vegetation, but were quite intact (testimony to the processes that yield mummified mammoths and bog-people). So too were the gaseous heads, which ceremoniously rose on one moon tide and trained their snouts to the night sky—a macabre silhouette the townsfolk will not soon forget.

## 11.2. Bury It

Conventional wisdom suggests that a quick way to conceal a carcass and have it decompose is to bury it. Maintain good public relations and avoid costly unearthing and re-burial by first agreeing on a site and obtaining permission from local authorities<sup>16</sup>. Choose a place where

destruction to the beach, vegetation, dunes, and wildlife (i.e., nesting birds) by the equipment or the hole it digs is trivial enough to justify the procedure. Complete all studies and sampling before the equipment arrives, because after the hole is dug, the remains will likely be buried, ready or not.

Some public landfill sites and private operators accept animal carcasses. Be aware of regulations and local statutes. Establish a time of delivery and make financial arrangements in advance. Advise the operators of any potential health risk, and bury under at least one or two meters of earth<sup>13,16</sup>. Bob Brownell<sup>4</sup> did just that with a pilot whale he meticulously dissected for later use as a skeleton, and meanwhile buried at the edge of the parking lot of the Cabrillo Beach Marine Museum in San Pedro, California...

*"The next spring, without notice, the city's road department sent a work crew to improve the parking lot, which they did. They extended it, graded it, then paved it over—whale and all."*

The rate of decomposition depends on the character of the remains, depth of burial, the terrain, and water and air temperature. A carcass that is rich with blubber will tend to rise in soft wet sand, even when split open and weighted down with tons of rocks. Four humpback whales that were buried in sandy beaches just below the tidal wash on the north shore of Cape Cod surfaced twice within a year and had to be reburied, and liquefying parts of others periodically emerged as sands shifted with tides and storms. Several carcasses that were only opened and left exposed had already deteriorated by that time.

There may be occasions when you wish to retrieve a carcass that someone else has recently buried. Peter Best<sup>2</sup> notes that attempting to use a vehicle to drag a carcass out of an opened grave tail-first is frustratingly unsuccessful. For cetaceans up to the size of a beaked whale, he suggests tying a long rope to the tail, but then pulling (with the vehicle) from the head end of the grave. After performing a neat headstand, the carcass tends to flip over onto the beach.

### **11.3. Move It**

When a carcass is a nuisance, hazard or public health risk, it may be possible simply to shift it to a more appropriate site. Permission at one or more levels of government may be required for any transfer, especially across state lines.

Small or rare animals are often removed intact to a facility for further

study or preservation. This is normally done with manatee carcasses because of the endangered status of the population. Floridians are especially protective of these endearing animals. While carting away a bloated carcass he retrieved from a lagoon, Dan Odell<sup>11</sup> was pursued by the Florida Marine Patrol and finally stopped by the Game and Freshwater Fish Commission for..

*"transporting a pregnant manatee in the back of my truck. I didn't know how fortunate I was at the time; only later did I discover that the group reporting the 'robbery' had considered using firearms to stop us. I immediately had the words MANATEE RESEARCH painted in LARGE letters all over the vehicle".*

Tom McIntyre's (National Marine Fisheries Service, Office of Protected Resources, Silver Spring, Md.) transport to the laboratory of three brewing carcasses stuffed into a family wagon was not perilous but perfumed.

*"One oversized dolphin lay diagonally in the wagon, flukes lashed to the left front window post, head right rear. One passenger had to lie atop the carcass, braced firmly to prevent falling onto the harbor seal alongside that was proceeding to self-destruct with gaseous gurglings. A barely 6-foot dolphin was wedged under the head of the first, with its abdomen and tail occupying most of the space designated for the other passenger. It was not the best of all worlds. For the six-hour drive, with the heater on full, all hands were frantically cranking windows in an ever changing array of up and down to find some level of comfort in the atmospheric inequities."*

Large carcasses will probably have to be moved in pieces. This is what Tom Murphy<sup>10</sup> had in mind for a dead humpback whale that stranded directly in front of a ritzy hotel on Hilton Head Island in South Carolina...

*"We contacted the Charleston Museum, which asked that we salvage the skeleton. The maintenance department quickly produced a bulldozer and an earthmover to drag the carcass to an undeveloped section of beach for temporary burial. As the two pieces of equipment pulled in tandem, they began to disappear in the soft sand while the whale remained firmly in place. I then suggested we cut the whale in half to simplify the job, and was offered a chain saw to speed up the operation. It cranked with the first pull and I climbed atop the whale to a position just behind the skull. By this time it was early evening and a large crowd had gathered, everyone with cocktails in hand. As the chain saw penetrated the blubber, I immediately realized that while the exterior looked fresh,*





© Geraci & Lounsbury 1993

**Fig. 11.1.** Various methods of carcass disposal, including moving to an alternate site, burial (after opening body cavity), cutting into smaller pieces for disposal, and towing out to sea (after opening body cavity).

*the inside was soup. The chain saw drove deep into the liquified entrails and produced a spray that plastered my legs and boots and then arched some 30 feet across the beach. As the sight and odor made its impact on the crowd, every martini got dumped onto the sand. The reality of a stranding event took over and the ambiance of the entire afternoon suddenly changed."*

#### 11.4. Tow It Out to Sea

A large carcass can be towed out to sea, providing it is released far enough offshore so that currents and winds will not bring it back, it is clear of a shipping lane, and has enough ballast to sink it. Helene Marsh<sup>8</sup> attempted to tow a dead minke whale head first. *"Its mouth opened and acted like some giant sea anchor. The trawler was going absolutely nowhere."*

John Heyning<sup>6</sup> had better success hauling a 75-foot blue whale carcass out to sea, off Southern California, where it floated like a ghost ship ...

*"The skipper, before securing a line to the flukes, asked if it would take one or two tons of chain to sink it. I estimated that after 5 days in the July sun, gases of decomposition had more likely generated about 10 tons of buoyancy to overcome. I informed the captain that even if his tug sank, it would only dangle from the bloated body. The skipper disregarded my warning, and for more than a month I received reports of a mangled whale carcass floating off Catalina Island with an enormous quantity of chain draped over its flukes."*

Greg Early<sup>5</sup> had a minke whale carcass in Lynn, Massachusetts, that was in such bad condition he decided not to open it, preferring instead to tow it out to sea. The Harbormaster granted permission, but decided to tow it himself. Two miles out, he let the carcass go, and it promptly blew across the bay onto Revere Beach. The Revere Department of Public Works, unaware of the previous odyssey, took another approach. They picked the whale up, stuffed it into a truck, drove it to the New England Aquarium, and asked the security guards where to leave it. "Out back" was the reply, pointing to the necropsy room. Greg was called down a few minutes later to find the whale he had decided not to cut up on the beach—and even riper now—had followed him to work, to be dissected at last.

The Coast Guard or Harbor Police may be willing to assist with towing a carcass to sea. It would be wise to consult them before making the attempt.

### **11.5. Render It**

Some rendering plants and commercial incinerators may accept marine mammals. It will probably be necessary to pay for this service, using licensed collectors to pick up and transport the carcasses. Disposal by rendering may require arrangements with federal and local authorities<sup>16</sup>.

### **11.6. Blow It Up**

It might seem logical to blow up a carcass, theoretically at least, into tiny pieces that no one will notice or care much about. This was tried once with a 14-meter, 8-ton whale in Oregon. It is all on videotape taken by Ron Finn, but equally vivid is Dave Barry's<sup>1</sup> animated description of the event.





*"The responsibility for getting rid of the carcass was placed upon the Oregon State Highway Division, apparently on the theory that highways and whales are very similar in the sense of being large objects.*

*So anyway, the highway engineers hit upon the plan—remember, I am not making this up—of blowing up the whale with dynamite. The thinking here was that the whale would be blown into small pieces, which would be eaten by seagulls, and that would be that. A textbook whale removal.*

*So they moved the spectators back up the beach, put a half-ton of dynamite next to the whale, and set it off. I am probably guilty of understatement when I say that what follows, on the videotape, is the most wonderful event in the history of the universe. First you see the whale carcass disappear in a huge blast of smoke and flame. Then you hear the happy spectators shouting 'Yayy!' and 'Wheee!' Then, suddenly, the crowd's tone changes. You hear a new sound, the sound of many objects hitting the ground with a noise that sounds like 'splud.' You hear a woman's voice shouting 'Here comes pieces of ...my GOD!' Something smears the camera lens.*

*Later, the reporter explains: 'The humor of the entire situation suddenly gave way to a run for survival as huge chunks of whale blubber fell everywhere.' One piece caved in the roof a car parked more than a quarter of a mile away. Remaining on the beach were several rotting whale sectors the size of condominium units. There was no sign of the seagulls, who had no doubt permanently relocated to Brazil."*

### **11.7. Burn It**

After deliberating on how to dispose of five hundred tons of stranded sperm whales in Florence, Oregon, in June 1979, the decision was made to burn the carcasses, at an unforeseen cost to the state of \$25,000. Bulldozers were used to push the carcasses into large pits dug in the shore. As told by Barry Lopez<sup>7</sup>, ..

*"the whales were ignited in pits—(it would finally be done with thousands of automobile and truck tires, cordwood, diesel fuel, and Alumagel)—as they burned they were rendered, and when their oil caught fire they began to boil in it. The seething roar was muffled by a steady offshore breeze; the oily black smoke drifted over the dunes—thinned until it disappeared against a weak blue sky."*

### 11.8. Afterward

Any person involved with the disposal of a carcass is bound to contact oils with lingering qualities, some more pleasant than others. Bob Bonde<sup>3</sup> worked on a right whale calf in Georgia...

*"..with a friend who does not believe in gloves and gets some perverse pleasure out of absorbing odors from dead creatures through his hands. That night we returned to Florida and put away the valuable skeleton. After washing up with everything from ammonia to bleach to mouth-wash, we decided to go to one of the University sporting events. Unfortunately, it was a sell-out game and we had to sit in close quarters. Occasionally, I would get a slight whiff of 'dead whale smell' and check my fingers. Not me. Soon, however, I noticed others in the stands smelling their hands too, squinching up their noses, stirring nervously and searching the soles of their shoes—telltale signs of annoying smells in a large crowd. We went home early that night, thankful that no one had found the source."*

### 11.9. Conclusion

The best way to deal with a carcass is to bury, remove, render or tow it. Few large-scale disposal operations will turn out as planned. It seems that for the near future at least, any advances to overcome these problems will continue to develop at a slower pace than the memorable stories of what went wrong.





*Chapter 12*  
**Health and Safety Risks**

**12.1.** Hazards to the Public.....239  
**12.2.** Hazards to the Team .....240  
**12.3.** Train and Plan for Safety..... 243  
References .....285

**12.1. Hazards to the Public**

A stranding scene is a good place to disregard the popular notions that a harbor seal is generally friendly, a sea lion preoccupied with mischievous antics, and a dolphin inherently playful and altruistic. By definition, a stranded animal is in trouble. With that, its behavior is unpredictable, and even a normally docile species may be frightened enough to attack. Even experienced persons have been seriously hurt by the thrashing flukes of a struggling whale or the unexpected rolling of a manatee. Such risk increases, of course, for one unaccustomed to the animal's behavior and untrained in rescue procedures. Apart from injury is the potential for infectious agents to be transmitted to persons coming into physical contact with a stranded animal. Those who would consider a stranded animal as edible should be cautioned that even apparently healthy animals can be a source of trichinosis (a parasitic infection), and harmful toxins from *Salmonella sp.*, *Clostridium sp.* and other bacteria<sup>1</sup>.

Any risk to the public, including that of disease transmission, can be avoided by establishing a safe boundary within which only the response team should operate. This can be accomplished and still satisfy the inevitable curiosity of observers (see Chapter 3).

Failure to take appropriate action may be viewed as inattention to public safety, forcing others in authority to take sterner measures. At a winter stranding in Nantucket, Mass. (Cape Cod), live pilot whales struggling on the beach and in the surf drew a large crowd of onlookers. While some futilely attempted to drag or roll the animals into the water, other bystanders climbed all over the whales and hoisted children onto them for photographs. Attempting to prevent mishap, local officials chose to drag the live animals by their tails overland to a secure area. All of the whales died, some during the move and others while they were unattended at the secondary site.

Such scenes can be avoided by good planning that will protect the public while looking after the well-being of the animals, and by proper and rapid disposal of carcasses (see Chapter 11). Do not underestimate the benefit of public education in the form of posters or pamphlets



dealing with these issues (see Chapter 3).

## 12.2. Hazards to the Team

Team members responding to a stranding face situations that can be risky, although less so than many leisure-time sporting activities. A person might be struck by a whale's flukes with appalling force, raked by teeth, rolled upon, knocked into the surf, suffer sunstroke or hypothermia, aches, strains and bruises, catch a faceful of blowhole discharge, and chance cuts by instruments and bone fragments. Despite such risks, **few serious injuries or illnesses have been reported as a result of working with stranded animals.** The greater the experience and training of the team, the better their regard for proper precautions, the less likelihood of a mishap.

Designating safety and staff support coordinators (see 2.6) at strandings involving a large number of volunteers will help to ensure that the team does not try to exceed its limitations. Ultimately, providing adequate support for the team will greatly diminish the chance of injuries. Fatigue and other discomforts, such as results from drinking too much coffee when no facilities are available, wearing wet, gritty clothing, or being hungry, can reduce morale and concentration, and thus increase the chance of accidents. The longer the operation or the more adverse the environmental conditions, the more vital essential comforts will become to the health and well-being of the response team.

### Transmissible Disease

Marine mammals harbor a variety of bacteria, fungi and viruses. Few of these organisms are routinely pathogenic when the term is taken to mean causing disease whenever present<sup>9</sup>. Some, however, have been transmitted from live animals and carcasses.

Several investigators working on an outbreak of seal influenza developed painful conjunctivitis caused by the same virus<sup>21</sup>. At least one poxvirus in seals can cause irritating skin lesions that take several months to heal<sup>11</sup>. The bacteria *Erysipelothrix* sp.<sup>15</sup>, *Leptospira* sp.<sup>6,18</sup>, and *Mycobacterium* sp.<sup>8,12</sup>, and the fungal agents *Blastomyces* sp.<sup>5</sup> and *Loboia lobo*<sup>20</sup> have also been transmitted to people from contaminated animals. "Seal finger," a condition resulting from contact with Atlantic and Arctic phocids, has recently been associated with a *Mycoplasma* infection<sup>13</sup> and is treated with tetracycline<sup>3</sup>. A similar condition known by the same name but from the Pacific coast<sup>14</sup> is caused by *Erysipelothrix* and responds to penicillin<sup>19</sup>. It is important to recognize the difference, since the treatment for one is ineffective against the other.

Several other organisms are potentially pathogenic to humans. Among

them are caliciviruses that seem to be endemic in California sea lions and northern fur seals<sup>17</sup>, bacteria of the genus *Vibrio*<sup>4</sup>, and the unlikely rabies virus that was recovered from a ringed seal from Svalbard, Norway<sup>16</sup>.

The **risk of disease is low** for persons who are healthy and free of disease conditions or medications (steroid hormones, immunosuppressive agents) that lower resistance to infection. Risk can be further reduced by taking the following preventive measures:

- wear (untorn) gloves when handling animals, carcasses, tissues or fluids
- wear waterproof outerwear to protect clothing from contamination
- cover surface wounds with protective dressings
- wash exposed skin (and clothing) after handling animals
- seek medical attention for bites, cuts and other injuries, and inform medical attendants of the injury's source

**Any illness that develops after exposure to marine mammals should be brought to the attention of a physician**, preferably one familiar with conditions potentially transferable from these animals. The occurrence should also be reported to stranding network officials who maintain records of physicians with such experience and record these incidents for future reference.

### Exposure

Workers on the beach normally protect themselves against overexposure to sun and heat by wearing proper clothing, using sunscreens, temporarily escaping into shade, and liberally drinking fluids. **Hyperthermia** (heatstroke) is seldom encountered except in those few who disregard these common sense precautions.

The greater threat is **hypothermia**, especially for persons who are wet and wind-chilled, or working in the water where heat is quickly lost to the surroundings. The earliest indication of cold stress is shivering, which occurs when body temperature is reduced by as little as 1° to 2°C. Eventual effects include skin reactions, allergic responses, lower blood pressure, and reduced heart rate and kidney function<sup>2,10</sup>. Persons may appear confused, sluggish and disoriented, perhaps believing themselves still physically able to work. Such behavior can, of course, place other team members at risk.

Prolonged exposure to cold air and water and reduced activity—precisely the circumstances encountered when rescuers must support animals in shallow water for prolonged periods—promote hypothermia. Going without food, or indulging in alcohol or drugs can also amplify the

effects<sup>2</sup>, in addition to impairing judgment.

Workers must be protected against the cold with adequate clothing (layering is best) and waterproof outerwear, gloves and boots. Special gear must be worn by personnel working in the water for any prolonged exposure at temperatures less than 30° to 32°C. Wind-surfing suits offer some protection for brief periods of immersion. Wet suits work best for people who are literally up to their necks in water by actively heating the insulating water layer. The neoprene also provides buoyancy, which is useful when trying to keep animals at the surface. Dry suits are superior for persons standing still for long time periods.

**A rotation schedule should be established for those holding animals in the water**, with limits set on the time that any individual might be in the water in one day. Exposure times will vary, depending on ambient temperatures and how well the crew is dressed and equipped. As a general rule, a worker in a dry suit can spend twice as long in the water as one in a wet suit. Recovery time afterwards is generally double the exposure time.

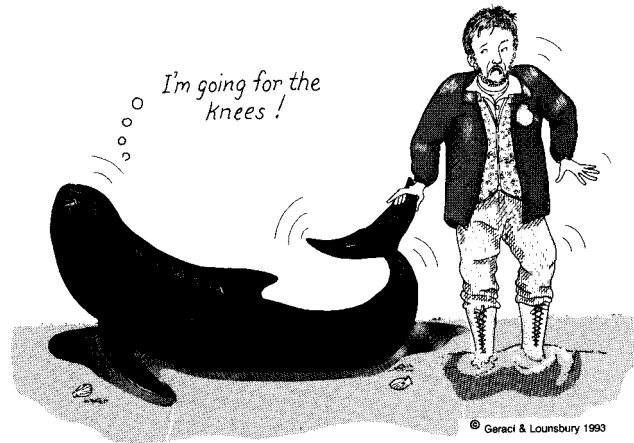
Meeting the personnel needs for a comfortable rotation schedule may not always be possible, even for a small stranding response. Consider a situation where the “in-water” time is limited to one hour, and 5 support personnel are required to hold each whale. Holding 10 whales for 5 hours would require 250 people if no staff were rotated, or 150 people rotated on a schedule of one-hour on, two-hours off. If adequate personnel cannot be enlisted for such a procedure, the response team must resist the temptation to “stretch themselves.”

### **Injury**

**Strandings afford numerous opportunities for injury.** Moving along slippery shorelines, lifting or rolling large animals and working with heavy equipment all present hazards to team members, particularly to those inattentive to the risks. Little can be done to make a stranding site safer, other than to mark off obstacles such as holes or bring in spotlights when the work carries on into the night. The designated safety officer should be continually on the look-out for potentially dangerous conditions or practices, and take appropriate action to reduce the chance of injury to personnel.

Heavy lifting equipment is usually, but not always, in the hands of experienced operators who will ensure that the loads are properly secured. Even so, ropes may break or knots fail, and no one should be allowed to stand under an overhead load. All personnel must stay clear when winching a carcass across a beach in case the line snaps.

The risk of drowning can never be disregarded. Heavy surf and



dangerous undertows can quickly turn an innocent attempt to help into a personal tragedy. Except for actions along the shoreline, no one should enter the water unless there are boats available to provide assistance if necessary.

**Procedures and equipment needed for euthanizing animals can** also be hazardous to personnel. Firearms and drugs must remain in the possession of authorized individuals who will take responsibility for their safe use (see 6.12). Only those with the authority and expertise to do so may perform such actions; people uninvolved in these activities will best avoid danger by leaving the area completely.

The basic equipment for a stranding response will include a first aid kit appropriately stocked to deal with cuts, abrasions, minor twists or sprains, and other routine injuries. The safety officer and stranding coordinator must know the location of nearby medical facilities, clinics and hospitals in the event of more serious mishaps. Police radios and portable phones are the best way to summon an ambulance.

### **Injury Reporting and Liability**

Accidents can occur in any field operation. Each stranding network should consult professionals to establish the legal framework for volunteers to operate. The safety officer or stranding coordinator should document and track the outcome of all injuries. Such information may be needed in the event that any result in legal action.

### **12.3. Train and Plan for Safety**

Training programs for those involved in stranding must include information on the hazards of the job. Injuries can be avoided through instruction on animal behavior and proper handling techniques. Learning to recognize dangerous situations such as soft mud, heavy surf, or





a beach of broken shells will prepare one to take appropriate action. **Accidents can be reduced by being aware of human limitations and setting realistic goals.**

**Task assignments must be made on the basis of training.** People must not become involved in potentially hazardous duties (i.e., handling animals, taking samples from live animals, working in the water) for which they are unqualified. The use of coded badges to indicate level and area of training will discourage this from happening, both on the part of the eager helper and on the part of the frustrated team leader desperate for another pair of hands.

Assignments must also take into consideration the availability of sufficient numbers of personnel for the task at hand, as determined by the safety officer or stranding coordinator. This is particularly crucial when the response involves work in the water during cold weather. When working in hazardous situations (e.g., heavy surf, cold water, or in darkness), organize workers in pairs (i.e., "buddy system") for additional safety.

The effects of exposure are of primary importance for coordinators planning field schedules. During mass strandings, 8 to 10 hours "in the field" followed by an 8- to 10-hour rest period generally works best<sup>7</sup>, but this may need to be tailored to the conditions. Ironically, if field support is good, volunteers may wish to spend longer periods in the field, risking physical and mental fatigue.

One person should keep track of the exposure time and rotation of workers, as the latter are likely to be too busy to check this themselves. In addition, the safety officer or assistants should watch personnel closely for early signs of hypothermia, particularly uncontrolled shivering. Anyone showing signs of shivering, stiffness or lack of coordination should be required to return to the support center for a period of recovery.

### **Recognizing Limitations**

Certain operations may need to be discontinued or plans modified if human safety is jeopardized. Attempts to carry or pull large animals with insufficient or fatigued personnel, or continued work in the water under weather conditions that have become adverse, are just two situations where the response goal must be weighed against staff safety. Once the safety and stranding coordinators determine the best course of action, other team members and participants must comply with this decision. **At no point in the response effort can "blind heroism" be allowed to obscure rational judgement.**

*Chapter 13*  
**The Follow-Up**

13.1. Collection and Distribution of Data .....	245
13.2. The Sample Trail.....	246
13.3. Who Pays? .....	246
13.4. A Press Conference.....	247
13.5. A Word of Thanks .....	247

**The file on a stranding event is never closed until all information has been archived for easy retrieval, tissues are safely stored for later analyses, team members are recognized for their efforts and informed of the outcome, and the community is thanked for its support.**

**13.1. Collection and Distribution of Data**

The story of an event is best written while memories are fresh and documents are readily accessible. Once everyone has retired from the scene, first-hand information is lost, and what the account gains in the re-telling, it loses in accuracy.

An informal “debriefing” meeting will elicit individual points of view, experiences, criticisms and suggestions. The person assigned to this task should have the skills to filter through the volume of information, recognize what is important, and condense it into useful form for the report.

Reports often are not prepared or completed for fear they may not meet the scrutiny of a colleague searching for critical details, impeccable precision and literary style. But that is hardly the purpose of the exercise. What is required immediately is a summary of the essential findings from each of the coordinators, including that from the debriefing meeting, accompanied by the kind of documentation that can later be organized, analyzed and refined. This summary is made available to team members, the relevant federal agencies, and if it merits, to other stranding networks. The report can be continually updated as new information becomes available, until it eventually emerges as a completed document.

**Points summarized in the report are:**

1. Notification of the stranding.
2. Eyewitness accounts.
3. Nature, timing, effectiveness of the initial response.



4. Account of the scene as first viewed by the team.
  - a. exact location
  - b. pattern of stranding
  - c. condition of animals
  - d. environmental conditions
5. The action taken and reasons for the decisions.
  - a. intended plan
  - b. impediments to implementation
  - c. eventual action
  - d. intended follow-up (monitoring released animals or following progress of rehabilitation)
6. Necropsy findings and any available laboratory results.
7. Types of data and specimens collected and their location.
8. Supplementary information.
  - a. maps, photographs, sketches
  - b. reports from independent groups, e.g., police, Coast Guard, wildlife authorities
9. Critique of methods and success; suggested improvements.

### **13.2. The Sample Trail**

Samples from strandings may be dispersed quickly to research and analytical laboratories, museums, universities, and tissue banks. Important opportunities to gain information have been lost because specimens have deteriorated, been poorly labeled or lost, the analyses not done or their results not reported. To avoid such misfortune:

- match codes (accession number) that each laboratory assigns to the same animal; keep records
- establish a system for tracking specimens (some pass through a series of laboratories)
- protect samples in your care from deteriorating (repackage as necessary; top-up preservatives)
- encourage expedient analysis
- assure that results will return into the central data bank, if necessary by contractual arrangement with the recipient.

### **13.3. Who Pays?**

The stranding network is responsible for settling all financial matters



arising from any action taken under its authority. Some institutions have a budget for this purpose; others may rely on donations and other sources of funding.

Maintain the support of loyal team members by immediately reimbursing personal expenses as pre-arranged. Settle accounts promptly with any contractor, laboratory, local business and private individual (veterinarian, equipment operator, diver), who should not be expected to absorb the costs (although many do).

#### **13.4. A Press Conference**

The media coordinator should consider organizing a press conference soon after any stranding event that has captured public interest. Informing the press and public of the response team's findings will encourage cooperation and support, and will promote public awareness. Allow for interviews and make copies of the condensed stranding report available to the press.

#### **13.5. A Word of Thanks**

Nearly everyone on the team devotes untiring effort for which the only compensation is the satisfaction of helping. Beyond that, the mayor of the town may have unleashed costly resources, the police worked unscheduled overtime, the community provided food and beverages,

the motel keeper bore the criticism of cleaner guests, and beach residents endured the trampling of their summer gardens. Compile a list of everyone involved. There is little we can do for their inconveniences that is more gratifying than providing each a summary of the incident and an expression of sincere thanks.

## References

### Chapter 1.

1. Aguilar, A. 1984. Relationship of DDE/ DDT in marine mammals to the chronology of DDT input into the ecosystem. *Canadian Journal of Fisheries and Aquatic Sciences* 41: 840-844.
2. Baker, V. [ed.]. 1986?. Marine mammal rescue. New Zealand Department of Conservation. 103 p.
3. Bowen, W.D., D.J. Boness and O.T. Oftedal. 1987. Mass transfer from mother to pup and subsequent mass loss by the weaned pup in the hooded seal, *Cystophora cristata*. *Canadian Journal of Zoology* 65: 1-8.
4. Dierauf, L.A., D. Vandebroek, J. Roletto, M. Koski, L. Amaya and L. Gage. 1985. An epizootic of leptospirosis in California sea lions. *Journal of the American Veterinary Medical Association* 187: 1145.
5. Gaskin, D.E. 1982. The ecology of whales and dolphins. Heinemann Publ., Exeter, NH. 459 p.
6. Gaskin, D.E., M. Holdrinet and R. Frank. 1982. DDT residues in blubber of harbour porpoise, *Phocoena phocoena* (L.), from eastern Canadian waters during the five-year period 1969-73. p. 135-143. *In* Mammals of the seas. Vol. 4. FAO (Food and Agriculture Organization of the United Nations) Publications, Rome.
7. Geraci, J.R., D.J. St. Aubin, I.K. Barker, R.G. Webster, V.S. Hinshaw, W.J. Bean, H.L. Ruhnke, J.H. Prescott, G. Early, A.S. Baker, S. Madoff and R.T. Schooley. 1982. Mass mortality of harbor seals: pneumonia associated with influenza A virus. *Science* 215: 1129-1131.
8. Geraci, J.R., D.M. Anderson, R.J. Timperi, D.J. St. Aubin, G.A. Early, J.H. Prescott and C.A. Mayo. 1989. Humpback whales (*Megaptera novaeangliae*) fatally poisoned by dinoflagellate toxin. *Canadian Journal of Fisheries and Aquatic Sciences* 46: 1895-1898.
9. Geraci, J.R. 1989. Clinical investigation of the 1987-88 mass mortality of bottlenose dolphins along the U.S. central and south Atlantic coast. Final Report to National Marine Fisheries Service, U.S. Navy (Office of Naval Research) and Marine Mammal Commission. 63 p.
10. Geraci, J.R., M.D. Dailey and D.J. St. Aubin. 1978. Parasitic mastitis in the Atlantic white-sided dolphin, *Lagenorhynchus acutus*, as a probable factor in herd productivity. *Journal of the Fisheries Research Board of Canada* 35: 1350-1355.
11. Geraci, J.R. and D.J. St. Aubin. 1979. Stranding workshop summary report: analysis of marine mammal strandings and recommendations for a nationwide stranding salvage program, p. 1-33. *In* J.R. Geraci and D.J. St. Aubin [eds.] *Biology of marine mammals: insights through strandings*. National Technical Information Service, Springfield, VA. NTIS PB-293 890.
12. Harwood, J. 1990. The 1988 seal epizootic. *Journal of Zoology (London)* 222: 349-351.
13. Hofman, R.J. 1991. History, goals, and achievements of the regional marine mammal stranding networks in the United States, p. 7-15. *In* J.E. Reynolds and D.K. Odell [eds.] *Marine mammal strandings in*

**Chapter 1 (continued)**

- the United States: proceedings of the second marine mammal stranding workshop, Miami, FL, Dec. 3-5, 1987. NOAA Technical Report NMFS 98.
14. Kennedy, S., J.A. Smyth, P.F. Cush, P. Duignan, M. Platten, S.J. McCullough and G.M. Allan. 1989. Histopathologic and immunocytochemical studies of distemper in seals. *Veterinary Pathology* 26: 97-103.
  15. Keyes, M.C. 1965. Pathology of the northern fur seal. *Journal of the American Veterinary Medical Association* 147: 1090-1095.
  16. Kritzler, H. 1949. The pilot whale at Marineland. *Natural History* 58: 302-308 & 331-332.
  17. Martin, A.R., P. Reynolds and M.G. Richardson. 1987. Aspects of the biology of pilot whales (*Globicephala melaena*) in recent mass strandings on the British coast. *Journal of Zoology (London)* 211: 11-23.
  18. Mead, J.G. 1979. An analysis of cetacean strandings along the east coast of the United States, p. 54-68. *In* J.R. Geraci and D.J. St. Aubin [eds.] *Biology of marine mammals: insights through strandings*. National Technical Information Service, Springfield, VA. NTIS PB-293 890.
  19. Mead, J.G. (Smithsonian Institution, Washington, DC). 1992. Personal communication.
  20. Osterhaus, A.D.M.E., J. Groen, H.E.M. Spijkers, H.W.J. Broeders, F.G.C.M. UytdeHaag, P. de Vries, J.S. Teppema, I.K.G. Visser, M.W.G. van de Bildt and E.J. Vedder. 1990. Mass mortality in seals caused by a newly discovered morbillivirus. *Veterinary Microbiology* 23: 343-350.
  21. Perrin, W.F. and J.E. Powers. 1980. Role of a nematode in natural mortality of spotted dolphins. *Journal of Wildlife Management* 44: 960-963.
  22. Reynolds, J.E., III and D.K. Odell [eds.]. 1991. *Marine mammal strandings in the United States: proceedings of the second marine mammal stranding workshop, Miami, FL, Dec. 3-5, 1987*. NOAA Technical Report NMFS 98.
  23. Robson, F. 1984. *Strandings: ways to save whales*. Science Press, Johannesburg. 124 p.
  24. Royal Society for the Prevention of Cruelty to Animals. 1988. *First aid for stranded cetaceans*. R.S.P.C.A., Horsham (U.K.). 20 p.
  25. Sergeant, D.E. and F.A.J. Armstrong. 1973. Mercury in seals from eastern Canada. *Journal of the Fisheries Research Board of Canada* 30: 843-846.
  26. Sergeant, D.E., D.J. St. Aubin and J.R. Geraci. 1980. Life history and northwest Atlantic status of the Atlantic white-sided dolphin. *Cetology* No. 37. 12 p.
  27. Visser, I.K.G., J.S. Teppema and A.D.M.E. Osterhaus. 1991. Virus infections of seals and other pinnipeds. *Reviews in Medical Microbiology* 2: 105-114.
  28. Warneke, R.M. [ed.]. 1986. *Victorian whale rescue plan: a contingency plan for strandings of cetaceans (whales, dolphins and porpoises) on*

**Chapter 1 (continued)**

- the Victorian coastline. Fisheries and Wildlife Service, Department of Conservation, Forests and Lands, Victoria. 75 p.
29. Wilkinson, D. 1991. Report to: assistant administrator for fisheries. Program review of the marine mammal stranding networks. U.S. Department of Commerce, NOAA, National Marine Fisheries Service, Washington, DC. 171 p.

**Chapter 3.**

1. Loew, F. (Tufts University, Boston, MA). 1991. Personal communication.
2. Scheffer, V.B. 1989. How much is a whale's life worth, anyway? *Oceanus* 32(1): 109-111.

**Chapter 4.**

1. Barrett, P. (Marine Mammal Center, Sausalito, CA). 1992. Personal communication.
2. Davis, R.W. 1990. Facilities and organization, p. 3-58. *In* T.M. Williams and R.W. Davis [eds.] Sea otter rehabilitation program: 1989 **Exxon Valdez** oil spill. International Wildlife Research.
3. Geraci, J.R. and D.J. St. Aubin and G.A. Early. 1987. Cetacean mass strandings: the study of stress and shock. Abstracts of the 7th Biennial Conference on the Biology of Marine Mammals, Dec. 5-9, 1987, University of Miami, Miami, FL. Society for Marine Mammalogy.

**Chapter 5.**

1. Addison, R.F. 1989. Organochlorines and marine mammal reproduction. *Canadian Journal of Fisheries and Aquatic Sciences* 46: 360-368.
2. Baker, J.R. 1984. Mortality and morbidity in grey seal pups (*Halichoerus grypus*). Studies on its causes, effects of environment, the nature and sources of infectious agents and the immunological status of pups. *Journal of Zoology (London)* 203: 23-48.
3. Barrett, P. (Marine Mammal Center, Sausalito, CA). 1992. Personal communication.
4. Bartholomew, G.A. 1970. A model for the evolution of pinniped polygyny. *Evolution* 24: 546-559.
5. Bigg, M.A. 1969. The harbour seal in British Columbia. Fisheries Research Board of Canada, Bulletin No. 172. 33 p.
6. Bigg, M.A. 1981. Harbour seal, *Phoca vitulina* and *Phoca largha*, p. 1-27. *In* S.H. Ridgway and R.J. Harrison [eds.] Handbook of marine mammals. Vol. 2. Academic Press, New York, NY.
7. Bigg, M.A. 1985. Status of the Steller sea lion, *Eumetopias jubatus*, and California sea lion, *Zalophus californianus*, in British Columbia. Canadian Special Publication of Fisheries and Aquatic Sciences No. 77. Department of Fisheries and Oceans, Ottawa. 20 p.
8. Bodkin, J.L. and R.J. Jameson. 1991. Patterns of seabird and marine mammal carcass deposition along the central California coast, 1980-1986. *Canadian Journal of Zoology* 69: 1149-1155.
9. Bonner, W.N. 1981. Grey seal *Halichoerus grypus* Fabricius, 1791, p.



**Chapter 5 (continued)**

- 111-144. In S.H. Ridgway and R.J. Harrison [eds.] Handbook of marine mammals. Vol. 2. Academic Press, New York, NY.
10. Boulva, J. and I.A. McLaren. 1979. Biology of the harbour seal, *Phoca vitulina*, in eastern Canada. Fisheries Research Board of Canada, Bulletin No. 200. 24 p.
  11. Bowen, W.D., O.T. Oftedal, and D.J. Boness. 1985. Birth to weaning in 4 days: remarkable growth in the hooded seal. Canadian Journal of Zoology 63: 2481-2486.
  12. Brodie, P. and B. Beck. 1983. Predation by sharks on the grey seal (*Halichoerus grypus*) in eastern Canada. Canadian Journal of Fisheries and Aquatic Sciences 40: 267-271.
  13. Burns, J.J. 1970. Remarks on the distribution and natural history of pagophilic pinnipeds in the Bering and Chukchi seas. Journal of Mammalogy 51: 445-454.
  14. Burns, J.J. 1981. Ribbon seal *Phoca fasciata* Zimmerman, 1783, p. 89-109. In S.H. Ridgway and R.J. Harrison [eds.] Handbook of marine mammals. Vol. 2. Academic Press, New York, NY.
  15. Burns, J.J. 1981. Bearded seal *Erignathus barbatus* Erxleben, 1777, p. 145-170. In S.H. Ridgway and R.J. Harrison [eds.] Handbook of marine mammals. Vol. 2. Academic Press, New York, NY.
  16. Burns, J.J. and A. Gavin. 1980. Recent records of hooded seals, *Cystophora cristata* Erxleben, from the western Beaufort Sea. Arctic 33: 326-329.
  17. Condit, R. and B.J. Le Boeuf. 1983. Density dependent regulation of elephant seal population. Abstracts of the 5th Biennial Conference on the Biology of Marine Mammals, Nov. 27-Dec.1, 1983, Boston, MA. Society for Marine Mammalogy.
  18. Dailey, M.D. 1970. The transmission of *Parafilaroides decorus* (Nematoda: Metastrongyloidea) in the California sea lion (*Zalophus californianus*). Proceedings of the Helminthological Society of Washington 37: 215-222.
  19. Daoust, P.Y., D. Haines, J. Thorsen, P. Duignan and J.R. Geraci. 1993. Phocine distemper in a harp seal (*Phoca groenlandica*) from the Gulf of St. Lawrence, Canada. Journal of Wildlife Diseases 29: 114-117.
  20. Deiter, R.L. 1991. Recovery and necropsy of marine mammal carcasses in and near the Point Reyes National Seashore, May 1982-March 1987, p. 123-141. In J.E. Reynolds and D.K. Odell [eds.] Marine mammal strandings in the United States: proceedings of the second marine mammal stranding workshop, Miami, FL, Dec. 3-5, 1987. NOAA Technical Report. NMFS 98.
  21. DeLong, R.L., W.G. Gilmartin and J.G. Simpson. 1973. Premature births in California sea lions: association with high organochlorine pollutant residue levels. Science 181: 1168-1170.
  22. DeLong, R.L., B.S. Stewart and R.D. Hill. 1992. Documenting migrations of northern elephant seals using day length. Marine Mammal Science 8: 155-159.
  23. Denison, D.M. and G.L. Kooyman. 1973. The structure and function of

**Chapter 5 (continued)**

- the small airways in pinniped and sea otter lungs. *Respiration Physiology* 17: 1-10.
24. Dierauf, L.A. 1983. A survey of live pinnipeds stranded along the northern California coast. *California Veterinarian* 6: 22-26.
  25. Dierauf, L.A. 1990. Pinniped husbandry, p. 553-590. *In* L.A. Dierauf [ed.] CRC handbook of marine mammal medicine: health, disease, and rehabilitation. CRC Press, Boca Raton, FL.
  26. Dierauf, L.A., D. Vandenbroek, J. Roletto, M. Koski, L. Amaya and L. Gage. 1985. An epizootic of leptospirosis in California sea lions. *Journal of the American Veterinary Medical Association* 187: 1145.
  27. Dudley, M. 1992. First Pacific record of a hooded seal, *Cystophora cristata* Erxleben, 1977. *Marine Mammal Science* 8: 164-168.
  28. Duignan, P. (Ontario Veterinary College, University of Guelph, Guelph, Ont.). 1992. Personal communication.
  29. Early, G.A. (New England Aquarium, Boston, MA). 1992. Personal communication.
  30. Early, G.A. and T.P. McKenzie. 1991. The Northeast regional marine mammal stranding network, p. 63-68. *In* J.E. Reynolds and D.K. Odell [eds.] Marine mammal strandings in the United States: proceedings of the second marine mammal stranding workshop, Miami, FL, Dec. 3-5, 1987. NOAA Technical Report NMFS 98.
  31. Fay, F.H. 1982. Ecology and biology of the Pacific walrus, *Odobenus rosmarus divergens* Illiger. U.S. Fish and Wildlife Service, North American Fauna No. 74. U.S. Department of Interior, Washington, DC. 279 p.
  32. Fay, F.H. (University of Alaska, Institute of Marine Science, Fairbanks, AK). 1992. Personal communication.
  33. Fay, F.H., B.P. Kelly, P.H. Gehrich, J.L. Sease and A.A. Hoover. 1986. Modern populations, migrations, demography, trophics, and historical status of the Pacific walrus. U.S. Department of Commerce and U.S. Department of Interior, Outer Continental Shelf Environmental Assessment Program (OCSEAP), Final Reports of the Principal Investigators 37: 231-376.
  34. Fay, F.H., B.P. Kelly, and J.L. Sease. 1989. Managing the exploitation of Pacific walruses: a tragedy of delayed response and poor communication. *Marine Mammal Science* 5: 1-16.
  35. Fowler, C.W. 1987. Marine debris and northern fur seals: a case study. *Marine Pollution Bulletin* 18(6B): 326-335.
  36. Gage, L. (Marine Mammal Center, Sausalito, CA). 1992. Personal communication.
  37. Gales, N. 1989. Chemical restraint and anesthesia of pinnipeds: a review. *Marine Mammal Science* 5: 228-256.
  38. Gentry, R.L. 1981. Northern fur seal *Callorhinus ursinus*, p. 143-160. *In* S.H. Ridgway and R.J. Harrison [eds.] Handbook of marine mammals. Vol. 1. Academic Press, New York, NY.
  39. Gentry, R.L., D.P. Costa, J.P. Croxall, J.H.M. David, R.W. Davis, G.L. Kooyman, P. Majluf, T.S. McCann and F. Trillmich. 1986. Synthesis and conclusions, p. 220-264. *In* R.L. Gentry and G.L. Kooyman [eds.]

**Chapter 5 (continued)**

- Fur seals: maternal strategies on land and at sea. Princeton University Press, Princeton, NJ.
40. Gentry, R.L. and J.R. Holt. 1982. Equipment and techniques for handling northern fur seals. NOAA Technical Report. NMFS SSRF-758. 15 p.
  41. Gentry, R.L. and J.H. Johnson. 1981. Predation by sea lions on northern fur seal neonates. *Mammalia* 45: 423-430.
  42. Gentry, R.L. and G.L. Kooyman. 1986. Introduction, p. 3-27. *In* R.L. Gentry and G.L. Kooyman [eds.] *Fur seals: maternal strategies on land and at sea*. Princeton University Press, Princeton, NJ.
  43. Geraci, J.R. 1981. *Marine mammal care*. 2nd ed. University of Guelph, Guelph, Ont. 98 p.
  44. Geraci, J.R. and D.J. St. Aubin. 1987. Effects of parasites on marine mammals. *International Journal for Parasitology* 17: 407-414.
  45. Geraci, J.R., D.J. St. Aubin, I.K. Barker, R.G. Webster, V.S. Hinshaw, W.J. Bean, H.L. Ruhnke, J.H. Prescott, G.A. Early, A.S. Baker, S. Madoff and R.T. Schooley. 1982. Mass mortality of harbor seals: pneumonia associated with influenza A virus. *Science* 215: 1129-1131.
  46. Geraci, J.R. and T.G. Smith. 1975. Functional hematology of ringed seals (*Phoca hispida*) in the Canadian Arctic. *Journal of the Fisheries Research Board of Canada* 32: 2559-2564.
  47. Gilmartin, W.G., R.L. DeLong, A.W. Smith, J.C. Sweeney, B.W. de Lappe, R.W. Risebrough, L.A. Griner, M.D. Dailey and D.B. Peakall. 1976. Premature parturition in the California sea lion. *Journal of Wildlife Diseases* 12: 104-115.
  48. Gilmartin, W.G., R.L. DeLong, A.W. Smith, L.A. Griner and M.D. Dailey. 1987. An investigation into unusual mortality in the Hawaiian monk seal, *Monachus schauinslandi*, p. 32-41. *In* W.G. Gilmartin [ed.] *Hawaiian monk seal die-off response plan, a workshop report*, 2 Apr. 1980, San Diego, CA. National Marine Fisheries Service, Southwest Fisheries Center Administrative Rep. H-87-19.
  49. Hansen, L.J. 1983. The cooperative marine mammal salvage program: Report on strandings of dead animals in 1981. National Marine Fisheries Service, Southwest Fisheries Center Administrative Rep. LJ-83-03. 20 p.
  50. Harwood, J. 1990. The 1988 seal epizootic. *Journal of Zoology (London)* 222: 349-351.
  51. Helle, E., M. Olsson and S. Jensen. 1976. DDT and PCB levels and reproduction in ringed seal from the Bothnian Bay. *Ambio* 5: 188-189.
  52. Hoover, A.A. 1988. Steller sea lion, *Eumatopias jubatus*, p. 159-193. *In* J.W. Lentfer [ed.] *Selected marine mammals of Alaska: species accounts with research and management recommendations*. Marine Mammal Commission, Washington, DC.
  53. Hoover, A.A. 1988. Harbor seal, *Phoca vitulina*, p. 125-157. *In* J.W. Lentfer [ed.] *Selected marine mammals of Alaska: species accounts with research and management recommendations*. Marine Mammal Commission, Washington, DC.
  54. Howell, A.B. 1930. *Aquatic mammals: their adaption to life in the water*. Charles C Thomas, Baltimore. 338 p.

**Chapter 5 (continued)**

55. Hubbard, R.C. 1968. Husbandry and laboratory care of pinnipeds, p. 299-358. *In* R.J. Harrison, R.C. Hubbard, R.S. Peterson, C.E. Rice and R.J. Schusterman [eds.] The behavior and physiology of pinnipeds. Appleton-Century-Crofts, New York, NY.
56. Kelly, B.P. 1988. Ringed seal, *Phoca hispida*, p. 57-75. *In* J.W. Lentfer [ed.] Selected marine mammals of Alaska: species accounts with research and management recommendations. Marine Mammal Commission, Washington, DC.
57. Kelly, B.P. 1988. Bearded seal, *Erignathus barbatus*, p. 77-94. *In* J.W. Lentfer [ed.] Selected marine mammals of Alaska: species accounts with research and management recommendations. Marine Mammal Commission, Washington, DC.
58. Kelly, B.P. 1988. Ribbon seal, *Phoca fasciata*, p. 95-106. *In* J.W. Lentfer [ed.] Selected marine mammals of Alaska: species accounts with research and management recommendations. Marine Mammal Commission, Washington, DC.
59. Kennedy, S., J.A. Smyth, P.F. Cush, P. Duignan, M. Platten, S.J. McCullough and G.M. Allan. 1989. Histopathologic and immunocytochemical studies of distemper in seals. *Veterinary Pathology* 26: 97-103.
60. Kenyon, K.W. 1981. Monk seals *Monachus* Fleming, 1822, p. 195-220. *In* S.H. Ridgway and R.J. Harrison [eds.] Handbook of marine mammals. Vol. 2. Academic Press Inc., New York, NY.
61. Keyes, M.C. 1965. Pathology of the northern fur seal. *Journal of the American Veterinary Medical Association* 147: 1090-1095.
62. Keyes, M.C. 1968. The nutrition of pinnipeds, p. 359-395. *In* R.J. Harrison, R.C. Hubbard, R.S. Peterson, C.E. Rice and R.J. Schusterman [eds.] The behavior and physiology of pinnipeds. Appleton-Century-Crofts, New York, NY.
63. King, J.E. 1983. Seals of the world. 2nd ed. Cornell University Press, Ithaca, NY. 240 p.
64. Laist, D.W. 1987. Overview of the biological effects of lost and discarded plastic debris in the marine environment. *Marine Pollution Bulletin* 18(6B): 319-326.
65. Laws, R.M. and R.J.F. Taylor. 1957. A mass mortality of crabeater seals *Lobodon carcinophagus* (Gray). *Proceedings of the Zoological Society of London* 129: 315-325.
66. Le Boeuf, B.J. and K.T. Briggs. 1977. The cost of living in a seal harem. *Mammalia* 41: 167-195.
67. Le Boeuf, B.J., R.J. Whiting and R.F. Gantt. 1972. Perinatal behavior of northern elephant seal females and their young. *Behaviour* 43:121-156.
68. Lien, J. (Memorial University, St. John's, Nfld.). 1992. Personal communication.
69. Loughlin, T.R. and R. Nelson, Jr. 1986. Incidental mortality of northern sea lions in Shelikof Strait, Alaska. *Marine Mammal Science* 2: 14-33.
70. Lowry, L.F. (Alaska Dept. of Fish and Game, Fairbanks, AK). 1992.

**Chapter 5 (continued)**

- Personal communication.
71. Lowry, L.F. and F.H. Fay. 1984. Seal eating by walruses in the Bering and Chukchi Seas. *Polar Biology* 3: 11-18.
  72. Mansfield, A.W. 1958. The biology of the Atlantic walrus, *Odobenus rosmarus rosmarus* (Linnaeus) in the eastern Canadian Arctic. Fisheries Research Board of Canada, Manuscript Report Series (Biology) No. 653. 146 p.
  73. Mansfield, A.W. and B. Beck. 1977. The grey seal in eastern Canada. Environment Canada Fisheries & Marine Service Technical Report No. 704. 81 p.
  74. Marine Mammal Center. 1986. Rescue techniques and procedures. Unpublished protocol issued for personnel responding to strandings. Marine Mammal Center, Sausalito, CA. 20 p.
  75. Marine Mammal Commission. 1992. Annual report to Congress 1991. Marine Mammal Commission, Washington, DC. 227 p.
  76. Markussen, N.H. and P. Have. 1992. Phocine distemper virus infection in harp seals, *Phoca groenlandica*. *Marine Mammal Science* 8: 19-26.
  77. McGinnis, S.M. and R.J. Schusterman. 1981. Northern elephant seal *Mirounga angustirostris* Gill, 1866, p. 329-349. In S.H. Ridgway and R.J. Harrison [eds.] *Handbook of marine mammals*. Vol. 2. Academic Press, New York, NY.
  78. McLaren, I.A. 1958. The biology of the ringed seal (*Phoca hispida* Schreber) in the eastern Canadian Arctic. Fisheries Research Board of Canada, Bulletin No. 118. 97 p.
  79. Merrick, R.L., T.R. Loughlin, and D.G. Calkins. 1987. Decline in abundance of the Northern sea lion, *Eumetopias jubatus*, in Alaska, 1956-86. *Fishery Bulletin* 85: 351-365.
  80. Mitchell, E.D. 1975. Parallelism and convergence in the evolution of Otariidae and Phocidae. *Rapports et Procès-Verbaux des Réunions Conseil International pour l'Exploration de la Mer* 169: 12-26.
  81. Odell, D.K. 1981. California seal lion *Zalophus californianus* (Lesson, 1828), p. 67-97. In S.H. Ridgway and R.J. Harrison [eds.] *Handbook of marine mammals*. Vol. 1. Academic Press Inc., New York, NY.
  82. Odell, D.K. 1991. A review of the southeastern United States marine mammal stranding network: 1978-1987, p. 19-23. In J.E. Reynolds and D.K. Odell [eds.] *Marine mammal strandings in the United States: proceedings of the second marine mammal stranding workshop*, Miami, FL, Dec. 3-5, 1987. NOAA Technical Report. NMFS 98.
  83. Osterhaus, A.D.M.E., J. Groen, H.E.M. Spijkers, H.W.J. Broeders, F.G.C.M. UytdeHaag, P. de Vries, J.S. Teppema, I.K.G. Visser, M.W.G. van de Bildt and E.J. Vedder. 1990. Mass mortality in seals caused by a newly discovered morbillivirus. *Veterinary Microbiology* 23: 343-350.
  84. Parsons, J. (Nova Scotia Stranding Network, Nova Scotia Museum, Halifax, Nova Scotia). 1992. Personal communication.
  85. Pike, G.C. and I.B. MacAskie. 1969. Marine mammals of British Columbia. Fisheries Research Board of Canada, Bulletin No. 171. 53p.

**Chapter 5 (continued)**

86. Quakenbush, L.T. 1988. Spotted seal, *Phoca largha*, p. 107-124. In J.W. Lentfer [ed.] Selected marine mammals of Alaska: species accounts with research and management recommendations. Marine Mammal Commission, Washington, DC.
87. Ralls, K., R.L. Brownell, Jr. and J. Ballou. 1980. Differential mortality by sex and age in mammals, with specific reference to the sperm whale. Report of the International Whaling Commission, Special Issue 2: 233-243.
88. Reeves, R.R. and J.K. Ling. 1981. Hooded seal *Cystophora cristata* Erxleben, 1777, p. 171-194. In S. Ridgway and R.J. Harrison [eds.] Handbook of marine mammals. Vol.2. Academic Press Inc., New York, NY.
89. Reijnders, P.J.H. 1980. Organochlorine and heavy metal residues in harbour seals from the Wadden Sea and their possible effects on reproduction. Netherlands Journal of Sea Research 14: 30-65.
90. Repenning, C.A. 1976. Adaptive evolution of sea lions and walruses. Systematic Zoology 25: 375-390.
91. Ronald, K. and P.J. Healey. 1981. Harp seal *Phoca groenlandica*, p. 55-87. In S.H. Ridgway and R.J. Harrison [eds.] Handbook of marine mammals. Vol. 2. Academic Press Inc., New York, NY.
92. Ruempler, G. 1986. [Biology, ecology and pathology of seals (*Phoca vitulina* L., 1758) of the North Sea]. Zeitschrift des Koelner Zoo 29: 135-157.
93. St. Aubin, D.J. 1990. Physiologic and toxic effects on pinnipeds, p. 103-127. In J.R. Geraci and D.J. St. Aubin [eds.] Sea mammals and oil: confronting the risks. Academic Press Inc., San Diego, CA.
94. Sandegren, F.E. 1970. Breeding and maternal behavior of the Steller sea lion (*Eumetopias jubatus*) in Alaska. M.S. Thesis, University of Alaska, College, AK.
95. Scheffer, V.B. 1958. Seals, sea lions and walruses. Stanford University Press, Stanford, CA. 179 p.
96. Schusterman, R.J. 1981. Steller sea lion *Eumetopias jubatus* (Schreber, 1776), p. 119-141. In S. Ridgway and R.J. Harrison [eds.] Handbook of marine mammals. Vol. 1. Academic Press Inc., New York, NY.
97. Scordino, J. 1991. Overview of the northwest region marine mammal stranding network, 1977-1987, p. 35-42. In J.E. Reynolds and D.K. Odell [eds.] Marine mammal strandings in the United States: proceedings of the second marine mammal stranding workshop, Miami, FL, Dec. 3-5, 1987. NOAA Technical Report. NMFS 98.
98. Seagers, D.J. and E.A. Jozwiak. 1991. The California marine mammal stranding network, 1972-1987: implementation, status, recent events, and goals, p. 25-33. In J.E. Reynolds and D.K. Odell [eds.] Marine mammal strandings in the United States: proceedings of the second marine mammal stranding workshop, Miami, FL, Dec. 3-5, 1987. NOAA Technical Report. NMFS 98.
99. Sease, J.L. and D.C. Chapman. 1988. Pacific walrus, *Odobenus rosmarus divergens*, p. 17-38. In J.W. Lentfer [ed.] Selected marine mammals of Alaska: species accounts with research and

**Chapter 5 (continued)**

- management recommendations. Marine Mammal Commission, Washington, DC.
100. Sergeant, D.E. 1991. Harp seals, man and ice. Canadian Special Publication of Fisheries and Aquatic Sciences 114. 153 p.
  101. Smith, T.G. 1976. The icy birthplace of the Arctic ringed seal. Canadian Geographical Journal 93: 58-63.
  102. Smith, T.G. 1980. Polar bear predation of ringed and bearded seals in the land-fast sea ice habitat. Canadian Journal of Zoology 58: 2201-2209.
  103. Smith, T.G. 1987. The ringed seal, *Phoca hispida*, of the Canadian western Arctic. Canadian Bulletin of Fisheries and Aquatic Sciences No. 216. 81 p.
  104. Spotte, S. 1990. Artificial milks for unweaned marine mammals, p. 521-532. In L.A. Dierauf [ed.] CRC handbook of marine mammal medicine: health, disease, and rehabilitation. CRC Press, Boca Raton, FL.
  105. Steiger, G.H., J. Calambokidis, J.C. Cubbage, D.E. Skilling, A.W. Smith and D.H. Gribble. 1989. Mortality of harbor seal pups at different sites in the inland waters of Washington. Journal of Wildlife Diseases 25: 319-328.
  106. Stobo, W.T. and B. Beck. 1987. Harbour seal pup production and pre-weaning mortality on Sable Island. Abstracts of the 7th Biennial Conference on the Biology of Marine Mammals, Dec. 5-9, University of Miami, Miami, FL. Society for Marine Mammalogy.
  107. Stroud, R.K. and M.D. Dailey. 1978. Parasites and associated pathology observed in pinnipeds stranded along the Oregon coast. Journal of Wildlife Diseases 14: 292-298.
  108. Stroud, R.K. and T.J. Roffe. 1979. Causes of death in marine mammals stranded along the Oregon coast. Journal of Wildlife Diseases 15: 91-98.
  109. Sweeney, J. 1974. Procedures for clinical management of pinnipeds. Journal of the American Veterinary Medical Association 165: 811-814.
  110. Trillmich, F. 1985. Effects of 1982/83 El Niño on Galapagos Island fur seals and sea lions. Noticias de Galapagos 42: 22-23.
  111. Visser, I.K.G., J.S. Teppema and A.D.M.E. Osterhaus. 1991. Virus infections of seals and other pinnipeds. Reviews in Medical Microbiology 2: 105-114.
  112. Wirtz, W.O., II. 1968. Reproduction, growth and development and juvenile mortality in the Hawaiian monk seal. Journal of Mammalogy 49: 229-238.
  113. Wyatt, T. 1980. Morrell's seals. Journal du Conseil, Conseil International pour l'Exploration de la Mer 39: 1-6.
  114. Wyss, A.R. 1989. Flippers and pinniped phylogeny: has the problem of convergence been overrated? Marine Mammal Science 5: 343-360.
  115. York, A.E. 1987. Northern fur seal, *Callorhinus ursinus*, Eastern Pacific population (Pribilof Islands, Alaska, and San Miguel Island, California), p. 9-21. In J.P. Croxall and R.L. Gentry [eds.] Status, biology and ecology of fur seals: proceedings of an international

**Chapter 5 (continued)**

symposium and workshop, Cambridge, England, 23-27 Apr. 1984. NOAA Technical Report. NMFS 51.

**Chapter 6.**

1. Addison, R.F. 1989. Organochlorines and marine mammal reproduction. *Canadian Journal of Fisheries and Aquatic Sciences* 46: 360-368.
2. Backus, R.H. and W.E. Schevill. The stranding of a Cuvier's beaked whale (*Ziphius cavirostris*) in Rhode Island, U.S.A. *Norsk Hvalfangst-tidende* 5:189-193.
3. Baird, R.W., K.M. Langelier and P.J. Stacey. 1988. Stranded whale and dolphin program of B.C. - 1987 report. *British Columbia Veterinary Medical Association Wildlife Veterinary Report* 1: 9-12.
4. Baker, V. [ed.]. 1986?. Marine mammal rescue. New Zealand Department of Conservation. 103 p.
5. Balcomb, K.C., III 1987. The whales of Hawaii. *Marine Mammal Fund, San Francisco*. 99 p.
6. Balcomb, K.C., III. 1989. Baird's beaked whale *Berardius bairdii* Stejneger, 1883: Arnoux's beaked whale *Berardius arnuxii* Duvernoy, 1851, p. 261-288. *In* S.H. Ridgway and R. Harrison [eds.] *Handbook of marine mammals*. Vol. 4: River dolphins and the larger toothed whales. Academic Press Ltd., London and San Diego.
7. Barnes, L.G., D.P. Domning and C.E. Ray. 1985. Status of studies on fossil marine mammals. *Marine Mammal Science* 1: 15-53.
8. Barnes, L.G. and E.D. Mitchell. 1978. Cetacea, p. 582-602. *In* V.J. Maglio and H.B.S. Cooke [eds.] *Evolution of African mammals*. Harvard University Press, Cambridge, MA.
9. Best, P.B. (Marine Mammal Research Institute, University of Cape Town, Cape Town, South Africa). 1992. Personal communication.
10. Bigg, M. 1982. An assessment of killer whale (*Orcinus orca*) stocks off Vancouver Island, British Columbia. *Report of the International Whaling Commission* 32: 655-666.
11. Bonde, R.K. and T.J. O'Shea. 1989. Sowerby's beaked whale (*Mesoplodon bidens*) in the Gulf of Mexico. *Journal of Mammalogy* 70: 447-449.
12. Bossart, G.D., D.K. Odell and N.H. Altman. 1985. Cardiomyopathy in stranded pygmy and dwarf sperm whales. *Journal of the American Veterinary Medical Association* 187: 1137-1140.
13. Brodie, P.F. 1989. The white whale *Delphinapterus leucas* (Pallas, 1776), p. 119-144. *In* S.H. Ridgway and R. Harrison [eds.] *Handbook of marine mammals*. Vol. 4: River dolphins and the larger toothed whales. Academic Press Ltd., London and San Diego.
14. Burn, D.M. and G.P. Scott. 1988. Synopsis of available information on marine mammal-fisheries interactions in the southeastern United States: preliminary report. National Marine Fisheries Service, Southeast Fisheries Center, Coastal Fishery Resource Division, Miami Laboratory, Miami, FL. 36 p.
15. Burns, J.J. and G.A. Seaman. 1985. Investigation of belukha whales in coastal waters of western and northern Alaska: II. biology and ecology. Final Report to U.S. Department of Commerce, National Oceanic and



**Chapter 6 (continued)**

- Atmospheric Administration, Offshore Continental Shelf Environmental Assessment Program (OCSEAP), Contract NA81RAC00049. Alaska Department of Fish and Game, Fairbanks. 129 p.
16. Caldwell, D.K. and M.C. Caldwell. 1989. Pygmy sperm whale *Kogia breviceps* (de Blainville, 1838): dwarf sperm whale *Kogia simus* Owen, 1866, p. 235-260. In S.H. Ridgway and R. Harrison [eds.] Handbook of marine mammals. Vol. 4: River dolphins and the larger toothed whales. Academic Press Ltd., London and San Diego.
  17. Caldwell, M.C. and D.K. Caldwell. 1966. Epimeletic (care-giving) behavior in Cetacea, p. 755-783. In K.S. Norris [ed.] Whales, dolphins and porpoises. University of California Press, Berkeley and Los Angeles, CA.
  18. Cawthorn, M. (Marine Mammal Specialist, Wellington, New Zealand). 1992. Personal communication.
  19. Cockrill, W.R. 1960. Pathology of the Cetacea: a veterinary study on whales - Part I. British Veterinary Journal 116: 1-28.
  20. Cockrill, W.R. 1960. Pathology of the Cetacea: a veterinary study on whales - Part II. British Veterinary Journal 116: 175-190.
  21. Cowan, D.F. 1966. Pathology of the pilot whale *Globicephala melaena*. Archives of Pathology 82: 178-189.
  22. Cowan, D.F. and W.A. Walker. 1979. Disease factors in *Stenella attenuata* and *Stenella longirostris* taken in the eastern tropical Pacific yellowfin tuna purse seine fishery. National Marine Fisheries Service, Southwest Fisheries Center Administrative Rep. No. LJ-79-32C. 19 p.
  23. Cowan, D.F., W.A. Walker and R.L. Brownell, Jr. 1986. Pathology of small cetaceans stranded along southern California beaches, p. 323-367. In M.M. Bryden and R.J. Harrison [eds.] Research on dolphins. Oxford University Press, Oxford.
  24. Cummings, W.C. 1985. Bryde's whale *Balaenoptera edeni* Anderson, 1878, p. 137-154. In S.H. Ridgway and R. Harrison [eds.] Handbook of marine mammals, Vol. 3: The sirenians and baleen whales. Academic Press, Inc., Orlando.
  25. Cummings, W.C. 1985. Right whales *Eubalaena glacialis* (Müller, 1776) and *Eubalaena australis* (Desmoulins, 1822), p. 275-304. In S.H. Ridgway and R. Harrison [eds.] Handbook of marine mammals, Vol. 3: The sirenians and baleen whales. Academic Press, Inc., Orlando.
  26. Dailey, M., M. Walsh, D. Odell and T. Campbell. 1981. Evidence of prenatal infection in the bottlenose dolphin (*Tursiops truncatus*) with the lungworm *Halocercus lagenorhynchi* (Nematoda: Pseudaliidae). Journal of Wildlife Diseases 22(1): 164-165.
  27. Deiter, R.L. 1991. Recovery and necropsy of marine mammal carcasses in and near the Point Reyes National Seashore, May 1982 - March 1987, p. 123-141. In J.E. Reynolds III and D.K. Odell [eds.] Marine mammal strandings in the United States: proceedings of the second marine mammal stranding workshop, Miami, FL, Dec. 3-5, 1987. NOAA Technical Report NMFS 98.
  28. Domingo, M., L. Ferrer, M. Pumarola, A. Marco, J. Plana, S. Kennedy,

**Chapter 6 (continued)**

- M. McAliskey and B.K. Rima. 1990. Morbillivirus in dolphins. *Nature* 348: 21.
29. Dudok van Heel, W.H. 1972. Transport of dolphins. *Aquatic Mammals* 1: 1-32.
  30. Duignan, P.J., J.R. Geraci, J.A. Raga and N. Calzada. 1992. Pathology of morbillivirus infection in striped dolphins (*Stenella coeruleoalba*) from Valencia and Murcia. *Canadian Journal of Veterinary Research* 56: 242-248.
  31. Early, G.A. (New England Aquarium, Boston, MA). 1992. Personal communication.
  32. Early, G.A. and T.P. McKenzie. 1991. The Northeast regional marine mammal stranding network, p. 63-68. *In* J.E. Reynolds and D.K. Odell [eds.] *Marine mammal strandings in the United States: proceedings of the second marine mammal stranding workshop*, Miami, FL, Dec.3-5, 1987. NOAA Technical Report NMFS 98.
  33. Elsner, R., J. Pirie, D.D. Kennedy and S. Schemmer. 1974. Functional circulatory systems of cetacean appendages, p. 143-159. *In* R.J. Harrison [ed.] *Functional anatomy of marine mammals*. Vol. 2. Academic Press, London and New York.
  34. Fowler, C.W. 1984. Density dependence in cetacean populations, p. 373-379. *In* W.F. Perrin, R.L. Brownell, Jr. and D.P. DeMaster [eds.] *Reproduction in whales, dolphins and porpoises*. Report of the International Whaling Commission, Special Issue 6. International Whaling Commission, Cambridge, U.K.
  35. Fritts, T.H., A.B. Irvine, R.D. Jennings, L.A. Collum, W. Hoffman, and M. A. McGehee. 1983. Turtles, birds, and mammals in the northern Gulf of Mexico and nearby Atlantic waters. U.S. Fish and Wildlife Service, Washington, DC. FWS/OBS-82/65. 455 p.
  36. Gales, N. (Underwater World, Perth, Australia). 1992. Personal communication.
  37. Gambell, R. 1985. Sei whale *Balaenoptera borealis* Lesson, 1828, p. 155-170. *In* S.H. Ridgway and R. Harrison [eds.] *Handbook of marine mammals*, Vol. 3: The sirenians and baleen whales. Academic Press, Inc., Orlando.
  38. Gambell, R. 1985. Fin whale *Balaenoptera physalus* (Linnaeus, 1758), p. 171-192. *In* S.H. Ridgway and R. Harrison [eds.] *Handbook of marine mammals*, Vol. 3: The sirenians and baleen whales. Academic Press, Inc., Orlando.
  39. Gaskin, D.E. 1982. *The ecology of whales and dolphins*. Heinemann Publ., Exeter, NH. 459 p.
  40. Gaskin, D.E., G.J.D. Smith, A.P. Watson, W.Y. Yasui and D.B. Yurick. 1984. Reproduction in the porpoises (Phocoenidae): implications for management, p. 135-148. *In* W.F. Perrin, R.L. Brownell, Jr. and D.P. DeMaster [eds.] *Reproduction in whales, dolphins and porpoises*. Report of the International Whaling Commission., Special Issue 6. International Whaling Commission, Cambridge, U.K.
  41. Geraci, J.R. 1981. *Marine mammal care*. 2nd ed. University of Guelph, Guelph, Ontario. 98 p.
  42. Geraci, J.R. 1989. Clinical investigation of the 1987-88 mass mortality

**Chapter 6 (continued)**

- of bottlenose dolphins along the U.S. central and south Atlantic coast. Final Report to National Marine Fisheries Service, U.S. Navy (Office of Naval Research) and Marine Mammal Commission. 63 p.
43. Geraci, J.R. 1990. Physiologic and toxic effects on cetaceans, p. 167-197. *In* J.R. Geraci and D.J. St. Aubin [eds.] Sea mammals and oil: confronting the risks. Academic Press, Inc., San Diego, CA.
  44. Geraci, J.R., D.M. Anderson, R.J. Timperi, D.J. St. Aubin, G.A. Early, J.H. Prescott and C.A. Mayo. 1989. Humpback whales (*Megaptera novaeangliae*) fatally poisoned by dinoflagellate toxin. *Canadian Journal of Fisheries and Aquatic Sciences* 46: 1895-1898.
  45. Geraci, J.R., M.D. Dailey and D.J. St. Aubin. 1978. Parasitic mastitis in the Atlantic white-sided dolphin, *Lagenorhynchus acutus*, as a probable factor in herd productivity. *Journal of the Fisheries Research Board of Canada* 35: 1350-1355.
  46. Geraci, J.R., N.C. Palmer and D.J. St. Aubin. 1988. Reply to Beland and Martineau. *Canadian Journal of Fisheries and Aquatic Sciences* 45: 1856.
  47. Geraci, J.R. and D.J. St. Aubin. 1979. Stress and disease in the marine environment: insights through strandings, p. 223-233. *In* J.R. Geraci and D.J. St. Aubin [eds.] Biology of marine mammals: insights through strandings. National Technical Information Service, Springfield, VA. PB-293 890.
  48. Geraci, J.R. and D.J. St. Aubin. 1987. Effects of parasites on marine mammals. *International Journal for Parasitology* 17: 407-414.
  49. Geraci, J.R. and D.J. St. Aubin and G.A. Early. 1987. Cetacean mass strandings: the study of stress and shock. Abstracts of the 7th Biennial Conference on the Biology of Marine Mammals, Dec. 5-9, 1987, University of Miami, Miami, FL. Society for Marine Mammalogy.
  50. Green, R.F. 1972. Observations on the anatomy of some cetaceans and pinnipeds, p. 247-297. *In* S.H. Ridgway [ed.] Mammals of the sea: biology and medicine. Charles C Thomas, Springfield, IL.
  51. Hare, M.P. and J.M. Mead. 1987. Handbook for determination of adverse human-marine mammal interactions from necropsies. National Marine Fisheries Service, Northwest and Alaska Fisheries Center Processed Rep. 87-06. 35 p.
  52. Harrison, R.J., F.R. Johnson and B.A. Young. 1970. The oesophagus and stomach of dolphins (*Tursiops*, *Delphinus*, *Stenella*). *Journal of Zoology (London)* 160: 377-390.
  53. Hay, K.A. and A.W. Mansfield. 1989. Narwhal *Monodon monoceros* Linnaeus, 1758, p. 145-176. *In* S.H. Ridgway and R. Harrison [eds.] Handbook of marine mammals. Vol. 4: River dolphins and the larger toothed whales. Academic Press Ltd., London and San Diego.
  54. Hazard, K. 1988. Beluga whale (*Delphinapterus leucas*), p. 195-235. *In* J.W. Lentfer [ed.] Selected marine mammals of Alaska: species accounts with research and management recommendations. Marine Mammal Commission, Washington, DC.
  55. Hersh, S.L. and D.K. Odell. 1986. Mass stranding of Fraser's dolphin, *Lagenodelphis hosei*, in the western North Atlantic. *Marine Mammal Science* 2: 73-76.

**Chapter 6 (continued)**

56. Heyning, J.E. 1989. Cuvier's beaked whale *Ziphius cavirostris* G. Cuvier, 1823, p. 289-308. *In* S.H. Ridgway and R. Harrison [eds.] Handbook of marine mammals. Vol. 4: River dolphins and the larger toothed whales. Academic Press Ltd., London and San Diego.
57. Hobbs, L. 1982. Appendix A. Tags on whales, dolphins, and porpoises, p. 218-230. *In* S. Leatherwood, R.R. Reeves, W.F. Perrin and W.E. Evans. Whales, dolphins, and porpoises of the eastern North Pacific and adjacent Arctic waters. NOAA Technical Report, NMFS Circular 144.
58. Howell, A.B. 1930. Aquatic mammals: their adaption to life in the water. Charles C. Thomas, Baltimore, MD. 338 p.
59. Irvine, A.B., R.S. Wells and M.D. Scott. 1982. An evaluation of techniques for tagging small odontocete cetaceans. Fishery Bulletin 80: 135-143.
60. Kasuya, T. and H. Marsh. 1984. Life history and reproductive biology of the short-finned pilot whale, *Globicephala macrorhynchus*, off the Pacific coast of Japan, p. 259-310. *In* W.F. Perrin, R.L. Brownell and D.P. DeMaster [eds.] Reproduction in whales, dolphins and porpoises. Report of the International Whaling Commission, Special Issue 6. International Whaling Commission, Cambridge, U.K.
61. Katona, S.K., V. Rough, and D.T. Richardson. 1983. A field guide to the whales, porpoises and seals of the Gulf of Maine and eastern Canada. 3rd ed. Charles Scribner's Sons, New York, NY. 255 p.
62. Kooyman, G.L. 1973. Respiratory adaptations in marine mammals. American Zoologist 13: 457-468.
63. Kraus, S.D. 1990. Rates and potential causes of mortality in North Atlantic right whales (*Eubalaena glacialis*). Marine Mammal Science 6: 278-291.
64. Krieger, K. (New England Aquarium, Boston, MA). 1992. Personal communication.
65. Lambertsen, R.H. and B.A. Kohn. 1987. Unusual multisystemic pathology in a sperm whale bull. Journal of Wildlife Diseases 23: 510-514.
66. Leatherwood, S., D.K. Caldwell, and H.E. Winn. 1976. Whales, dolphins, and porpoises of the western North Atlantic: a guide to their identification. NOAA Technical Report, NMFS Circular 396, Seattle, WA. 176 p.
67. Leatherwood, S., R.R. Reeves, W.F. Perrin and W.E. Evans. 1982. Whales, dolphins, and porpoises of the eastern North Pacific and adjacent Arctic waters: a guide to their identification. NOAA Technical Report, NMFS Circular 444, Seattle, WA. 245 p.
68. Lien, J. (Ocean Sciences Centre, Memorial University of Newfoundland, St. John's, Newfoundland). 1992. Personal communication.
69. Lockyer, C. 1976. Growth and energy budgets of large baleen whales from the southern hemisphere. FAO (Food and Agriculture Organization of the United Nations) Advisory Committee on Marine Resources Research, ACMRR/MM/SC/41. 179 p.
70. Lockyer, C. 1984. Review of baleen whale (Mysticeti) reproduction and implications for management, p. 27-50. *In* W.F. Perrin, R.L. Brownell,

**Chapter 6 (continued)**

- Jr. and D.P. DeMaster [eds.] Reproduction in whales, dolphins and porpoises. Report of the International Whaling Commission, Special Issue 6. International Whaling Commission, Cambridge, U.K.
71. Lowry, L.G. (Alaska Dept. Fish and Game, Fairbanks, AK). 1992. Personal communication.
  72. Lowry, L.G., R.R. Nelson and K.J. Frost. 1987. Observations of killer whales, *Orcinus orca*, in western Alaska: sightings, strandings, and predation on other marine mammals. *Canadian Field Naturalist* 101: 6-12.
  73. Martineau, D., A. Lagace, P. Beland, R. Higgins, D. Armstrong and L.R. Shugart. 1988. Pathology of stranded beluga whales (*Delphinapterus leucas*) from the St. Lawrence estuary, Quebec, Canada. *Journal of Comparative Pathology* 98: 287-311.
  74. Mead, J.G. 1975. Anatomy of the external nasal passages and facial complex in the Delphinidae (Mammalia: Cetacea). *Smithsonian Contributions to Zoology* 207: 1-72.
  75. Mead, J.G. 1979. An analysis of cetacean strandings along the east coast of the United States, p. 54-68. *In* J.R. Geraci and D.J. St. Aubin [eds.] *Biology of marine mammals: insights through strandings*. National Technical Information Service, Springfield, VA. NTIS PB-293 890.
  76. Mead, J.G. 1989. Bottlenose whales *Hyperoodon ampullatus* (Forster, 1770) and *Hyperoodon planifrons* Flower, 1882, p. 321-348. *In* S.H. Ridgway and R. Harrison [eds.] *Handbook of marine mammals*. Vol. 4: River dolphins and the larger toothed whales. Academic Press Ltd., London and San Diego.
  77. Mead, J.G. 1989. Beaked whales of the genus *Mesoplodon*, p. 349-430. *In* S.H. Ridgway and R. Harrison [eds.] *Handbook of marine mammals*. Vol. 4: River dolphins and the larger toothed whales. Academic Press Ltd., London and San Diego.
  78. Mead, J.G. (Smithsonian Institution, Washington, DC). 1992. Personal communication.
  79. Murphy, T. (South Carolina Wildlife and Marine Resources Department, Charleston, SC). 1992. Personal communication.
  80. Nagorsen, D.W. and G.E. Stewart. 1983. A dwarf sperm whale (*Kogia simus*) from the Pacific coast of Canada. *Journal of Mammalogy* 64: 505-506.
  81. Nerini, M. 1984. A review of gray whale feeding ecology, p. 423-450. *In* M.L. Jones, S.L. Swartz and S. Leatherwood [eds.] *The gray whale *Eschrichtius robustus**. Academic Press, Inc., Orlando, FL.
  82. Nitta, E.T. 1991. The marine mammal stranding network for Hawaii, an overview, p. 55-62. *In* J.E. Reynolds and D.K. Odell [eds.] *Marine mammal strandings in the United States: proceedings of the second marine mammal stranding workshop*, Miami, FL, Dec. 3-5, 1987. NOAA Technical Report NMFS 98.
  83. Norris, K.S. and T.P. Dohl. 1980. The structure and functions of cetacean schools, p. 211-261. *In* L.M. Herman [ed.] *Cetacean behavior: mechanisms and functions*. John Wiley & Sons, Inc., New York, NY.

**Chapter 6 (continued)**

84. Norris, K.S. and J.H. Prescott. 1961. Observations on Pacific cetaceans of Californian and Mexican waters. University of California Publications in Zoology 63: 291-401.
85. Obendorf, D.L. and J.H. Arundel. 1986. Veterinary aspects of whale strandings, p. 42-67. *In* R.M. Warneke [ed.] Victorian whale rescue plan: a contingency plan for strandings of cetaceans (whales, dolphins and porpoises) on the Victorian coastline. Fisheries and Wildlife Service, Department of Conservation, Forests and Lands, Victoria.
86. Odell, D.K. 1991. A review of the southeastern United States marine mammal stranding network: 1978-1987, p. 19-21. *In* J.E. Reynolds and D.K. Odell [eds.] Marine mammal strandings in the United States: proceedings of the second marine mammal stranding workshop, Miami, FL, Dec. 3-5, 1987. NOAA Technical Report NMFS 98.
87. Ohsumi, S. 1979. Interspecies relationships among some biological parameters in cetaceans and estimation of the natural mortality coefficient of the Southern Hemisphere minke whale. Report of the International Whaling Commission 29: 397-406.
88. Overstrom, N.A., S. Spotte, J.L. Dunn, A.D. Goren and H.W. Kaufman. 1991. A resident belukha whale (*Delphinapterus leucas*) in Long Island Sound, p. 143-149. *In* J.E. Reynolds III and D.K. Odell [eds.] Marine mammal strandings in the United States: proceedings of the second marine mammal stranding workshop, Miami, FL, Dec. 3-5, 1987. NOAA Technical Report NMFS 98.
89. Perrin, W.F. 1992. (NMFS, Southwest Fisheries Center, La Jolla, CA). Personal communication.
90. Perrin, W.F., E.D. Mitchell, J.G. Mead, D.K. Caldwell, M.C. Caldwell, P.J.H. van Bree and W.H. Dawbin. 1987. Revision of the spotted dolphins, *Stenella spp.* Marine Mammal Science 3: 99-170.
91. Perrin, W.F. and A.C. Myrick, Jr. [eds.]. 1980. Report of the workshop, p. 1-50. *In* Age determination of toothed whales and sirenians. Report of the International Whaling Commission, Special Issue 3. International Whaling Commission, Cambridge, U.K.
92. Perrin, W.F. and J.E. Powers. 1980. Role of a nematode in natural mortality of spotted dolphins. Journal of Wildlife Management 44: 960-963.
93. Perrin, W.F. and S.B. Reilly. 1984. Reproductive parameters of dolphins and small whales of the family Delphinidae, p. 97-133. *In* W.F. Perrin, R.L. Brownell, Jr. and D.P. DeMaster [eds.] Reproduction in whales, dolphins and porpoises. Report of the International Whaling Commission, Special Issue 6. International Whaling Commission, Cambridge, U.K.
94. Phillips, S.S. 1988. Observations on a mass stranding of *Pseudorca crassidens* at Crowdy Head, New South Wales, p. 33-41. *In* M.L. Augee [ed.] Marine mammals of Australasia: field biology and captive management. Royal Zoological Society of New South Wales, Special Publication, Sydney, New South Wales.
95. Pike, G.C. and I.B. MacAskie. 1969. Marine mammals of British Columbia. Fisheries Research Board of Canada, Bulletin No. 171. 53p.

**Chapter 6 (continued)**

96. Pippard, L. 1985. Status of the St. Lawrence River population of beluga. *Canadian Field Naturalist* 99: 438-450.
97. Pivorunas, A. 1979. The feeding mechanisms of baleen whales. *American Scientist* 67: 432-440.
98. Ralls, K., R.L. Brownell, Jr. and J. Ballou. 1980. Differential mortality by sex and age in mammals, with specific reference to the sperm whale. Report of the International Whaling Commission, Special Issue 2: 233-243.
99. Read, A.J. and D.E. Gaskin. 1988. Incidental catch of harbor porpoises by gill nets. *Journal of Wildlife Management* 52: 517-523.
100. Reeves, R.R. and S.K. Katona. 1980. Extralimital records of white whales (*Delphinapterus leucas*) in eastern North American waters. *Canadian Field Naturalist* 94: 239-247.
101. Reeves, R.R. and S. Leatherwood. 1985. Bowhead whale *Balaena mysticetus* Linnaeus, 1758, p. 305-344. In S.H. Ridgway and R. Harrison [eds.] *Handbook of marine mammals, Vol. 3: The sirenians and baleen whales*. Academic Press, Inc., Orlando.
102. Reeves, R.R. and E. Mitchell. 1987. Underwater world: cetaceans of Canada. Department of Fisheries and Oceans, Ottawa. 27 p.
103. Rice, D.W. 1989. Sperm whale *Physeter macrocephalus* Linnaeus, 1758, p. 177-233. In S.H. Ridgway and R. Harrison [eds.] *Handbook of marine mammals. Vol. 4: River dolphins and the larger toothed whales*. Academic Press Ltd., London and San Diego.
104. Ridgway, S.H. 1972. Homeostasis in the aquatic environment, p. 590-747. In S.H. Ridgway [ed.] *Mammals of the sea: biology and medicine*. Charles C Thomas, Springfield, IL.
105. Ridgway, S.H. (Naval Ocean Systems Center, San Diego, CA). 1992. Personal communication.
106. Ridgway, S.H. and M.D. Dailey. 1972. Cerebral and cerebellar involvement of trematode parasites in dolphins and their possible role in stranding. *Journal of Wildlife Diseases* 8: 33-43.
107. Ridgway, S.H. and C.A. Fenner. 1982. Weight-length relationships of wild-caught and captive Atlantic bottlenose dolphins. *Journal of the American Veterinary Medical Association* 181: 1310-1315.
108. Right Whale Recovery Team. 1990. Draft national recovery plan for the northern right whale, *Eubalaena glacialis*. U.S. Dept. Commerce, NOAA, National Marine Fisheries Service, Washington, DC. 77 p.
109. Robson, F. 1984. Strandings: ways to save whales. Science Press, Johannesburg (South Africa). 124 p.
110. Rommel, S.A., D.A. Pabst, W.A. McLellan, J.G. Mead and C.W. Potter. 1992. Anatomical evidence for a countercurrent heat exchanger associated with dolphin testes. *Anatomical Record* 232: 150-156.
111. Rowell, S.F. 1985. Stranded whales. *Veterinary Record* 116: 167.
112. Royal Society for the Prevention of Cruelty to Animals. 1985. Report of the stranded whale workshop: a practical and humanitarian approach. R.S.P.C.A., Horsham (U.K.). 64 p.
113. Royal Society for the Prevention of Cruelty to Animals. 1988. First aid for stranded cetaceans. R.S.P.C.A., Horsham (U.K.). 20 p.

**Chapter 6 (continued)**

114. Scheffer, V.B. 1989. How much is a whale's life worth, anyway? *Oceanus* 32(1): 109-111.
115. Schmidly, D.J. 1981. Marine mammals of the southeastern United States coast and the Gulf of Mexico. U.S. Fish and Wildlife Service, Office of Biological Services, Washington, DC., FWS/OBS-80/41. 163 p.
116. Schmidly, D.J. and S.H. Shane. 1978. A biological assessment of the cetacean fauna of the Texas coast. Marine Mammal Commission, Washington, DC. 38 p.
117. Scholander, P.F. and W.E. Schevill. 1955. Counter-current vascular heat exchange in the fins of whales. *Journal of Applied Physiology* 8: 279-287.
118. Schryver, H.F., W. Medway and J.F. Williams. 1967. The stomach fluke *Braunina cordiformis* in the Atlantic bottlenose dolphin. *Journal of the American Veterinary Medical Association* 151: 884-886.
119. Scordino, J. 1991. Overview of the northwest region marine mammal stranding network, 1977-1987, p. 35-42. *In* J.E. Reynolds and D.K. Odell [eds.] Marine mammal strandings in the United States: proceedings of the second marine mammal stranding workshop, Miami, FL, Dec. 3-5, 1987. NOAA Technical Report NMFS 98.
120. Scott, M.C., R.S. Wells and A.B. Irvine. 1990. A long-term study of bottlenose dolphins on the west coast of Florida, p. 235-244. *In* S. Leatherwood and R.R. Reeves [eds.] The bottlenose dolphin. Academic Press, Inc., San Diego, CA.
121. Seagars, D.J. and E.A. Jozwiak. 1991. The California marine mammal stranding network, 1971-1987: implementation, status, recent events, and goals, p. 25-33. *In* J.E. Reynolds and D.K. Odell [eds.] Marine mammal strandings in the United States: proceedings of the second marine mammal stranding workshop, Miami, FL, Dec. 3-5, 1987. NOAA Technical Report NMFS 98.
122. Sergeant, D.E. 1962. The biology of the pilot or pothead whale *Globicephala melaena* (Traill) in Newfoundland waters. Fisheries Research Board of Canada, Bulletin No. 132. 84 p.
123. Sergeant, D.E. and H.D. Fisher. 1957. The smaller Cetacea of eastern Canadian waters. *Journal of the Fisheries Research Board of Canada* 14: 83-115.
124. Sergeant, D.E., A.W. Mansfield and B. Beck. 1970. Inshore records of Cetacea for Eastern Canada, 1949-1968. *Journal of the Fisheries Research Board of Canada* 27: 1903-1915.
125. Sergeant, D.E. and G.A. Williams. 1983. Two recent entrapments of narwhals, *Monodon monoceros*, in Arctic Canada. *Canadian Field Naturalist* 97: 459-460.
126. Simpson, J.G. and M.B. Gardner. 1972. Comparative microscopic anatomy of selected marine mammals, p. 298-418. *In* S.H. Ridgway [ed.] Mammals of the sea: biology and medicine. Charles C. Thomas, Springfield, IL.
127. Smith, T.D., D.J. St. Aubin and J.R. Geraci. 1990. Research on beluga whales, *Delphinapterus leucas*: introduction and overview, p. 1-5. *In* T.D. Smith, D.J. St. Aubin and J.R. Geraci [eds.] Advances in research on the beluga whale, *Delphinapterus leucas*. Canadian



**Chapter 6 (continued)**

- Bulletin of Fisheries and Aquatic Sciences No. 224.
128. Smithsonian Institution Marine Mammal Events Program. Smithsonian Institution, Washington, DC. (Records, courtesy J. Mead).
  129. Stewart, B.S. and S. Leatherwood. 1985. Minke whale *Balaenoptera acutorostrata* Lacépède, 1804, p. 91-136. In S.H. Ridgway and R. Harrison [eds.] Handbook of marine mammals, Vol. 3: The sirenians and baleen whales. Academic Press, Inc., Orlando.
  130. Stolk, A. 1962. Tumors in whales. III. Granuloma malignum (Hodgkin's disease) in the fin whale *Balaenoptera physalus*. Proceedings of the Koninklijke Nederlandse Akademie van Wetenschappen 65: 250-268.
  131. Stroud, R.K. and T.J. Roffe. 1979. Causes of death in marine mammals stranded along the Oregon coast. Journal of Wildlife Diseases 15: 91-98.
  132. Sullivan, R.M. and W.J. Houck. 1979. Sightings and strandings of cetaceans from northern California. Journal of Mammalogy 60: 828-833.
  133. Sweeney, J.C. 1989. What practitioners should know about whale stranding, p. 721-727. In R. Kirk [ed.] Current Veterinary Therapy. 10th ed. W.B. Saunders, Co., Philadelphia, PA.
  134. Sweeney, J.C. and S.H. Ridgway. 1975. Procedures for the clinical management of small cetaceans. Journal of the American Veterinary Medical Association 167: 540-545.
  135. Tarpley, R.J. 1981. Structural studies of the alimentary system of the bowhead whale, *Balaena mysticetus*, p. 1-42. In R.J. Tarpley, R.F. Sis, M.J. Shively and G.G. Stott, Structural studies of the alimentary, reproductive and skeletal systems of the bowhead whale (*Balaena mysticetus*). Final Report for the Period 1 Sept. 81 through 31 Aug. 82 to the North Slope Borough, Barrow, Alaska. Department of Veterinary Anatomy, Texas A&M College of Veterinary Medicine, College Station, TX.
  136. Tarpley, R.J. 1987. Texas marine mammal stranding network. Southwest Veterinarian 38: 51-58.
  137. Thomson, C. and J.R. Geraci. 1986. Cortisol, aldosterone, and leucocytes in the stress response of bottlenose dolphins, *Tursiops truncatus*. Canadian Journal of Fisheries and Aquatic Sciences 43: 1010-1016.
  138. Townsend, F. (Gulfarium, Ft. Walton Beach, FL). 1992. Personal communication.
  139. U.S. Humpback Whale Recovery Team. 1989. National recovery plan for the humpback whale (*Megaptera novaeangliae*) in waters of the United States of America. U.S. Dept. of Commerce, NOAA, NMFS, Washington, DC. 115 p.
  140. U.S. Marine Mammal Commission. 1992. Annual report to Congress 1991. Marine Mammal Commission, Washington, DC. 227 p.
  141. Van Bresseem, M.F., I.K.G. Visser, M.W.G. Van De Bildt, J.S. Teppema, J.A. Raga and A.D.M.E. Osterhaus. 1991. Morbillivirus infection in Mediterranean striped dolphins (*Stenella coeruleoalba*). Veterinary Record 129: 471-472.

**Chapter 6 (continued)**

142. Vidal, O. 1991. Catalogue of osteological collections of aquatic mammals from Mexico. NOAA Technical Report NMFS 97. 36 p.
143. Walker, W.A. and D.F. Cowan. 1981. Air sinus parasitism and pathology in free-ranging common dolphins (*Delphinus delphis*) in the Eastern Tropical Pacific. National Marine Fisheries Service, Southwest Fisheries Center Administrative Rep. No. LJ-81-23C. 19 p.
144. Walsh, M. (Sea World, Inc., Orlando, FL). 1992. Personal communication.
145. Warneke, R.M. [ed.]. 1986. Victorian whale rescue plan: a contingency plan for strandings of cetaceans (whales, dolphins and porpoises) on the Victorian coastline. Fisheries and Wildlife Service, Department of Conservation, Forests and Lands, Victoria. 75 p.
146. Watson, L. 1981. Sea guide to whales of the world. Elsevier-Dutton Publ. Co., New York, NY. 302 p.
147. Wells, R.S., A.B. Irvine and M.D. Scott. 1980. The social ecology of inshore odontocetes, p. 263-317. *In* L.M. Herman [ed.] Cetacean behavior: mechanisms and functions. John Wiley & Sons, Inc., New York, NY.
148. Wilkinson, D. 1991. Report to: Assistant Administrator for Fisheries. Program review of the marine mammal stranding networks. U.S. Department of Commerce, NOAA, NMFS, Washington, DC. 171 p.
149. Winn, H. (Principal Investigator). 1980. Cetacean and Turtle Assessment Program, University of Rhode Island. A characterization of marine mammals and turtles in the Mid-and North Atlantic areas of the U.S. Outer Continental Shelf, annual report for 1980. Bureau of Land Management, Washington, DC. 468 p.
150. Winn, H.E. and N.E. Reichley. 1985. Humpback whale *Megaptera novaeangliae* (Borowski, 1781), p. 241-273. *In* S.H. Ridgway and R. Harrison [eds.] Handbook of marine mammals, Vol. 3: The sirenians and baleen whales. Academic Press, Inc., Orlando.
151. Wolman, A.A. 1985. Gray whale *Eschrichtius robustus* (Lilljeborg, 1861), p. 67-90. *In* S.H. Ridgway and R. Harrison [eds.] Handbook of marine mammals, Vol. 3: The sirenians and baleen whales. Academic Press, Inc., Orlando.
152. Würsig, B. 1990. Cetaceans and oil: ecologic perspectives, p. 129-165. *In* J.R. Geraci and D.J. St. Aubin [eds.] Sea mammals and oil: confronting the risks. Academic Press, Inc., San Diego, CA.
153. Yochem, P.K. and S. Leatherwood. 1985. Blue whale *Balaenoptera musculus* (Linnaeus, 1758), p. 193-240. *In* S.H. Ridgway and R. Harrison [eds.] Handbook of marine mammals, Vol. 3: The sirenians and baleen whales. Academic Press, Inc., Orlando.
154. Zeh, J., C. Clark, J. George, D. Withrow, G. Carroll and W. Koski. 1993. Current population size and dynamics, p. 409-489. *In* The bowhead whale. Society for Marine Mammalogy.
155. Zimmerman, S.T. 1991. A history of marine mammal stranding networks in Alaska, with notes on the distribution of the most commonly stranded cetacean species, 1975-1987, p. 43-53. *In* J.E. Reynolds and D.K. Odell [eds.] Marine mammal strandings in the United States: proceedings of the second marine mammal stranding workshop, Miami, FL, Dec. 3-5, 1987. NOAA Technical Report NMFS 98.

**Chapter 7.**

1. Baird, R.W., K.M. Langelier and P.J. Stacey. 1989. First records of false killer whales (*Pseudorca crassidens*) in Canada. *Canadian Field Naturalist* 103: 368-371.
2. Bauer, G.B., M. Fuller, A. Perry, J.R. Dunn and J. Zoeger. 1985. Magnetoreception and biomineralization of magnetite in cetaceans, p. 489-507. *In* J.L. Kirschvink, D.S. Jones and B.J. MacFadden [eds.] *Magnetite biomineralization and magnetoreception in organisms*. Plenum Press, New York, NY.
3. Bossart, G.D., M.T. Walsh, D.K. Odell, J.D. Lynch, D.O. Buesse, R. Friday, and W.G. Young. 1991. Histopathologic findings of a mass stranding of pilot whales, *Globicephala macrorhynchus*, p. 85-90. *In* J.E. Reynolds and D.K. Odell [eds.] *Marine mammal strandings in the United States: proceedings of the second marine mammal stranding workshop*, Miami, FL, Dec. 3-5, 1987. NOAA Technical Report NMFS 98.
4. Bigg, M. 1982. An assessment of killer whale (*Orcinus orca*) stocks off Vancouver Island, British Columbia. Report of the International Whaling Commission 32: 655-666.
5. Breland, K. and M. Breland. 1966. *Animal behavior*. MacMillan, New York, NY. 210 p.
6. Caldwell, D.K., M.C. Caldwell and C.M. Walker, Jr. 1970. Mass and individual strandings of false killer whales, *Pseudorca crassidens*, in Florida. *Journal of Mammalogy* 51: 634-636.
7. Caldwell, M.C. and D.K. Caldwell. 1966. Epimeletic (care-giving) behavior in Cetacea, p. 755-783. *In* K.S. Norris [ed.] *Whales, dolphins and porpoises*. University of California Press, Berkeley and Los Angeles, CA.
8. Colgrove, G.S. and G. Migaki. 1976. Cerebral abscess associated with stranding in a dolphin. *Journal of Wildlife Diseases* 12: 271-274.
9. Cornwell-Huston, C.J. 1987. Further analysis of cetacean mass strandings and geomagnetic parameters along the North American eastern seaboard. Abstracts of the 7th Biennial Conference on the Biology of Marine Mammals, Dec. 5-9, 1987, Miami, FL. Society for Marine Mammalogy.
10. Credle, V.R. 1987. Biogenic magnetite isolated from the dura of pygmy sperm whales. Abstracts of the 7th Biennial Conference on the Biology of Marine Mammals, Dec. 5-9, 1987, Miami, FL. Society for Marine Mammalogy.
11. Dawson, S.M., S. Whitehouse and M. Willisroft. 1985. A mass stranding of pilot whales in Tryphena Harbour, Great Barrier Island. *Investigations on Cetacea* 17: 165-173.
12. Dudok van Heel, W.H. 1962. Sound and cetacea. *Netherlands Journal of Sea Research* 1: 407-507.
13. Dudok van Heel, W.H. 1966. Navigation in Cetacea, p. 597-606. *In* K.S. Norris [ed.] *Whales, dolphins and porpoises*. University of California Press, Berkeley, CA.
14. Early, G.A. (New England Aquarium, Boston, MA). 1992. Personal communication.

**Chapter 7 (continued)**

15. Fehring, W.K. and R.S. Wells. 1976. A series of strandings by a single herd of pilot whales on the west coast of Florida. *Journal of Mammalogy* 57: 191-194.
16. Fowler, C.W. 1984. Density dependence in cetacean populations, p. 373-379. *In* W.F. Perrin, R.L. Brownell, Jr. and D.P. DeMaster [eds.] *Reproduction in whales, dolphins and porpoises*. Report of the International Whaling Commission, Special Issue 6. International Whaling Commission, Cambridge, U.K.
17. Geraci, J.R. 1978. The enigma of marine mammal strandings. *Oceanus* 21(2): 38-47.
18. Geraci, J.R. and D.J. St. Aubin. 1977. Mass stranding of the long-finned pilot whale, *Globicephala melaena*, on Sable Island, Nova Scotia. *Journal of the Fisheries Research Board of Canada* 34: 2196-2199.
19. Geraci, J.R. and D.J. St. Aubin. 1979. Stranding workshop summary report: analysis of marine mammal strandings and recommendations for a nationwide stranding salvage program, p. 1-33. *In* J.R. Geraci and D.J. St. Aubin [eds.] *Biology of marine mammals: insights through strandings*. National Technical Information Service, Springfield, VA. NTIS PB-293 890.
20. Geraci, J.R. and D.J. St. Aubin. 1987. Effects of parasites on marine mammals. *International Journal for Parasitology* 17: 407-414.
21. Geraci, J.R., D.J. St. Aubin and G.A. Early. 1987. Cetacean mass strandings: the study of stress and shock. Abstracts of the 7th Biennial Conference on the Biology of Marine Mammals, Dec. 5-9, 1987, University of Miami, Miami, FL. Society for Marine Mammalogy.
22. Geraci, J.R., S.A. Testaverde, D.J. St. Aubin and T.H. Loop. 1978. A mass stranding of the Atlantic white-sided dolphin (*Lagenorhynchus acutus*): a study into pathobiology and life history. National Technical Information Service, Springfield, VA. NTIS PB-289 361.
23. Gilmore, R.M. 1957. Whales aground in Cortés Sea. *Pacific Discovery* 10(1): 22-27.
24. Gilmore, R.M. 1959. On the mass strandings of sperm whales. *Pacific Naturalist* 1(10): 9-16.
25. Gould, J.L. 1985. Are animal maps magnetic?, p. 257-268. *In* J.L. Kirschvink, D.S. Jones and B.J. MacFadden [eds.] *Magnetite biomineralization and magnetoreception in organisms*. Plenum Press, New York, NY.
26. Gresson, R.A.R. 1968. White-sided dolphins, *Lagenorhynchus acutus* (Gray) stranded at Ventry Harbor, Co. Kerry. *Irish Naturalist Journal* 16: 19-20.
27. Guiler, E.R. 1978. Whale strandings in Tasmania since 1945 with notes on some seal reports. *Papers and Proceedings Royal Society of Tasmania* 112: 189-213.
28. Hall, N.R. and R.D. Schimpff. 1979. Neuropathology in relation to strandings: mass stranded whales, p. 236-241. *In* J.R. Geraci and D.J. St. Aubin [eds.] *Biology of marine mammals: insights through strandings*. National Technical Information Service, Springfield, VA. NTIS PB-293 890.

**Chapter 7 (continued)**

29. Herman, L.M. and W.N. Tavolga. 1980. The communication systems of cetaceans, p. 149-209. *In* L.M. Herman [ed.] Cetacean behavior: mechanisms and functions. John Wiley & Sons, Inc., New York and Toronto.
30. Irvine, A.B., M.D. Scott, R.S. Wells and J.G. Mead. 1979. Stranding of the pilot whale, *Globicephala macrorhynchus*, in Florida and South Carolina. *Fishery Bulletin* 77: 511-513.
31. Jenner, C., M.N. M-Jenner and P.H. Forestell. 1989. Repeated behavioral observation of six photo-identified adult pygmy killer whales during one month prior to stranding by three members of the group. Abstracts of the 8th Biennial Conference on the Biology of Marine Mammals, Dec. 7-11, Pacific Grove, CA. Society for Marine Mammalogy.
32. Johnson, C.S. 1986. Dolphin audition and echolocation capacities, p. 115-136. *In* R.J. Schusterman, J.A. Thomas and F.G. Wood [eds.] Dolphin cognition and behavior: a comparative approach. Lawrence Erlbaum Associates, Inc., Hillsdale, NJ.
33. Kellogg, W.N., R. Kohler and H.M. Morris. 1953. Porpoise sounds as sonar signals. *Science* 117: 239-243.
34. Kirschvink, J.L., A.E. Dizon and J.A. Westphal. 1986. Evidence from strandings for geomagnetic sensitivity in cetaceans. *Journal of Experimental Biology* 120: 1-24.
35. Kirschvink, J.L., D.S. Jones and B.J. MacFadden. 1985. Magnetoreception and magnetic minerals in living organisms, p. 255-256. *In* J.L. Kirschvink, D.S. Jones and B.J. MacFadden [eds.] Magnetite biomineralization and magnetoreception in organisms. Plenum Press, New York, NY.
36. Klinowska, M. 1985. Cetacean live stranding sites relate to geomagnetic topography. *Aquatic Mammals* 1: 27-32.
37. Klinowska, M. 1986. Cetacean live stranding dates relate to geomagnetic disturbances. *Aquatic Mammals* 11: 109-119.
38. Klinowska, M. 1986. The cetacean magnetic sense: evidence from strandings, p. 401-432. *In* M.M. Bryden and R.J. Harrison [eds.] Research on dolphins. Oxford University Press, Oxford.
39. Lambertsen, R.H., B. Birnir, and J.E. Bauer. 1986. Serum chemistry and evidence of renal failure in the north Atlantic fin whale population. *Journal of Wildlife Diseases* 22: 389-396.
40. Leahy, T.M. 1977. The mystery of the beached mammals. *NOAA Magazine*, April: 4-8.
41. Leatherwood, S., C.L. Hubbs and M. Fisher. 1979. First records of Risso's dolphin (*Grampus griseus*) from the Gulf of California with detailed notes on a mass stranding. *Transactions of the San Diego Society of Natural History* 19: 45-52.
42. Marsh, H. and T. Kasuya. 1986. Evidence for reproductive senescence in female cetaceans, p. 57-74. *In* G.D. Donovan [ed.] Behavior of whales in relation to management. Report of the International Whaling Commission, Special Issue 8. International Whaling Commission, Cambridge, U.K.

**Chapter 7 (continued)**

43. McBride, A.F. 1956. Evidence for echolocation by cetaceans. *Deep-Sea Research* 3: 153-154.
44. McManus, T.J., J.E. Wapstra, E.R. Guiler, B.L. Munday and D.L. Obendorf. 1984. Cetacean strandings in Tasmania from February 1978 to May 1983. *Papers and Proceedings Royal Society Tasmania* 118: 117-135.
45. Mead, J.G. 1979. An analysis of cetacean strandings along the east coast of the United States, p. 54-68. *In* J.R. Geraci and D.J. St. Aubin [eds.] *Biology of marine mammals: insights through strandings*. National Technical Information Service, Springfield, VA. NTIS PB-293 890.
46. Mead, J.G., D.K. Odell, R.S. Wells and M.D. Scott. 1980. Observations on a mass stranding of spinner dolphins, *Stenella longirostris*, from the west coast of Florida. *Fishery Bulletin* 78: 353-360.
47. Mell, D. 1988. An operational perspective of the rescue of false killer whales, *Pseudorca crassidens*, stranded at Augusta in July 1986, p. 43-57. *In* M.L. Augee [ed.] *Marine mammals of Australasia: field biology and captive management*. Royal Zoological Society of New South Wales, Special Publication, Sydney, New South Wales.
48. Mitchell, E. 1975. Porpoise, dolphin and small whale fisheries of the world. International Union for Conservation of Nature and Natural Resources, London, Monograph No. 3. 129 p.
49. Morimitsu, T., T. Nagai, M. Ide, H. Kawano, A. Naichuu, M. Koono and A. Ishii. 1987. Mass stranding of Odontoceti caused by parasitogenic eighth cranial neuropathy. *Journal of Wildlife Diseases* 23: 586-590.
50. Munday, B.L., R.H. Green and D.L. Obendorf. 1982. A pygmy right whale *Caperea marginata* (Gray, 1846) stranded at Stanley, Tasmania. *Papers and Proceedings Royal Society of Tasmania* 116: 1-4.
51. Nachtigall, P.E. 1986. Vision, audition, and chemoreception in dolphins and other marine mammals, p. 79-113. *In* R.J. Schusterman, J.A. Thomas and F.G. Wood [eds.] *Dolphin cognition and behavior: a comparative approach*. Lawrence Erlbaum Associates, Inc., Hillsdale, NJ.
52. Nicol, D.J. 1985. Oceanographic features that may influence cetacean strandings around Tasmania. Whale Stranding Programme, Environmental Studies Research Project No. 25, Research Report No. 1. Centre for Environmental Studies, University of Tasmania, Hobart. 46 p.
53. Nishiwaki, M. 1967. Distribution and migration of marine mammals in the North Pacific area. Ocean Research Institute, University of Tokyo, Bulletin No. 1. 64 p.
54. Norris, K.S. 1966. Some observations on the migration and orientation of marine mammals, p. 101-125. *In* *Animal orientation and navigation*. Proceedings of the 27th Annual Biology Colloquium, Oregon State University Press, Corvallis, OR.
55. Norris, K.S. and T.P. Dohl. 1980. The structure and functions of cetacean schools, p. 211-261. *In* L.M. Herman [ed.] *Cetacean behavior: mechanisms & functions*. John Wiley & Sons, Inc., New York and Toronto.

**Chapter 7 (continued)**

56. Odell, D.K., E.D. Asper, J. Baucom and L.H. Cornell. 1980. A recurrent mass stranding of the false killer whale, *Pseudorca crassidens*, in Florida. Fishery Bulletin 78: 171-177.
57. Odell, D.K., D.M. Burn, D.B. Olson and E.D. Asper. 1985. Strandings of dwarf and pygmy sperm whales (*Kogia* spp.) on the east coast of Florida. Abstracts of the 6th Biennial Conference on the Biology of Marine Mammals, Nov. 22-26, Vancouver, B.C. Society for Marine Mammalogy.
58. Phillips, S.S. 1988. Observations on a mass stranding of *Pseudorca crassidens* at Crowdy Head, New South Wales, p. 33-41. In M.L. Augee [ed.] Marine mammals of Australasia: field biology and captive management. Royal Zoological Society of New South Wales, Special Publication, Sydney, New South Wales.
59. Popper, A.N. 1980. Sound emission and detection by delphinids, p. 1-52. In L.M. Herman [ed.] Cetacean behavior: mechanisms and functions. John Wiley & Sons, Inc., New York and Toronto.
60. Porter, J.W. 1977. *Pseudorca* stranding. Oceans 10: 8-15.
61. Rancurel, P. 1974. (Mass stranding of cetaceans *Peponocephala electra* in the New Hebrides). Biological Conservation 6: 232-234.
62. Ridgway, S.H. and M.D. Dailey. 1972. Cerebral and cerebellar involvement of trematode parasites in dolphins and their possible role in stranding. Journal of Wildlife Diseases 8: 33-43.
63. Robinson, G., F. Koster and J. Villa. 1983. Stranding of Cuvier's beaked whales on Baltra. Noticias de Galapagos 38: 16-17.
64. Robson, F.D. 1984. Strandings: ways to save whales. Science Press, Johannesburg. 124 p.
65. Robson, F.D. and P.J.H. van Bree. 1971. Some remarks on a mass stranding of sperm whales, *Physeter macrocephalus* Linnaeus, 1758, near Gisborne, New Zealand, on March 18, 1970. Zeitschrift fuer Saeugetierkunde 36: 55-60.
66. Rumage, W.T., G. Early and H. Lind. 1987. Modeling of current and meteorological parameters associated with mass strandings of pilot whales in Wellfleet Bay. Abstracts of the 7th Biennial Conference on the Biology of Marine Mammals, Dec. 5-9, 1987, Miami, FL. Society for Marine Mammalogy.
67. Scammon, C.M. 1874. The marine mammals of the northwestern coast of North America. Dover Publications Inc., New York. 319 p.
68. Scott, E.G.O. 1942. Records of Tasmanian Cetacea: No. 1. Notes on the various strandings near Stanley, northwestern Tasmania. Records of the Queen Victoria Museum 1: 27-51.
69. Sergeant, D.E. 1982. Mass strandings of toothed whales (Odontoceti) as a population phenomenon. Scientific Reports of the Whales Research Institute (Tokyo) 34: 1-47.
70. Sergeant, D.E. and H.D. Fisher. 1957. The smaller Cetacea of eastern Canadian waters. Journal of the Fisheries Research Board of Canada 14: 83-115.
71. Sergeant, D.E., A.W. Mansfield and B. Beck. 1970. Inshore records of Cetacea for Eastern Canada, 1949-1968. Journal of the Fisheries Research Board of Canada 27: 1903-1915.

**Chapter 7 (continued)**

72. Sergeant, D.E. 1979. Ecological aspects of cetacean stranding. *In* J.R. Geraci and D.J. St. Aubin [eds.] *Biology of marine mammals: insights through strandings*. National Technical Information Service, Springfield, VA. NTIS PB-293 890.
73. Sheldrick, M.C. 1979. Cetacean strandings along the coasts of the British Isles 1913-1977, p. 35-53. *In* J.R. Geraci and D.J. St. Aubin [eds.] *Biology of marine mammals: insights through strandings*. National Technical Information Service, Springfield, VA. NTIS PB-293 890.
74. Thomas, J.A., W.W.L. Au, C.W. Turl and J.L. Pawloski. 1989. Sensory systems of false killer whales. Abstracts of the 8th Biennial Conference on the Biology of Marine Mammals, Dec. 7-11, Pacific Grove, CA. Society for Marine Mammalogy.
75. Tomilin, A.G. 1957. Cetacea. Mammals of the U.S.S.R. and adjacent countries, Vol. IX. Translated from Russian by Israel Program for Scientific Translations, Jerusalem, 1967. 717 p.
76. van Bree, P.J.H. 1977. On former and recent strandings of cetaceans on the coast of the Netherlands. *Zeitschrift fuer Saeugetierkunde* 42: 101-107.
77. Walker, M.M., J.L. Kirschvink and A.E. Dizon. 1985. Evidence that fin whales (*Balaenoptera physalus*) migrate in areas of low geomagnetic field gradient. Abstracts of the 6th Biennial Conference on the Biology of Marine Mammals, Nov. 22-26, Vancouver, B.C. Society for Marine Mammalogy.
78. Walker, M.M., J.L. Kirschvink and A.E. Dizon. 1985. Associations between cetacean live strandings and geomagnetic field parameters. Abstracts of the 6th Biennial Conference on the Biology of Marine Mammals, Nov. 22-26, Vancouver, B.C. Society for Marine Mammalogy.
79. Walker, W.A. and D.F. Cowan. 1981. Air sinus parasitism and pathology in free-ranging common dolphins (*Delphinus delphis*) in the eastern tropical Pacific. National Marine Fisheries Service, Southwest Fisheries Center Administrative Report No. LJ-81-23C. 19 p.
80. Walsh, M.T., D.O. Buesse, W.G. Young, J.D. Lynch, E.D. Asper, D.K. Odell. 1991. Medical findings in a mass stranding of pilot whales, *Globicephala macrorhynchus*, in Florida, p. 75-83. *In* J.E. Reynolds and D.K. Odell [eds.] *Marine mammal strandings in the United States: proceedings of the second marine mammal stranding workshop*, Miami, FL, Dec. 3-5, 1987. NOAA Technical Report NMFS 98.
81. Walsh, M.T., D.K. Odell, G. Young, E.D. Asper, and G. Bossart. 1990. Mass strandings of cetaceans, p. 673-683. *In* L.A. Dierauf [ed.] *Handbook of marine mammal medicine: health, disease, and rehabilitation*. CRC Press, Boca Raton, FL.
82. Walsh, M.T. (Sea World Inc., Orlando, FL.). 1992. Personal communication.
83. Warneke, R.M. [ed.]. 1986. Victorian whale rescue plan: a contingency plan for strandings of cetaceans (whales, dolphins and porpoises) on the Victorian coastline. Fisheries and Wildlife Service, Department of Conservation, Forests and Lands, Victoria. 75 p.



**Chapter 7 (continued)**

84. Wood, F.G. 1979. The cetacean stranding phenomenon: an hypothesis, p. 129-188. *In* J.R. Geraci and D.J. St. Aubin [eds.] *Biology of marine mammals: insights through strandings*. National Technical Information Service, Springfield, VA. NTIS PB-293 890.
85. Zoeger, J., J.R. Dunn and M. Fuller. 1981. Magnetic material in the head of the common Pacific dolphin. *Science* 213: 892-894.

**Chapter 8.**

1. Ackerman, B.B. 1992. Ongoing manatee aerial survey programs - a progress report [abstract], p. 14-15. *In* T.J. O'Shea, B.B. Ackerman and H.F. Percival [eds.] *Interim report of the technical workshop on manatee population biology*. Manatee Population Research Report No. 10. Florida Cooperative Fish and Wildlife Research Unit, University of Florida, Gainesville, FL.
2. Ackerman, B.B., S.D. Wright, R.K. Bonde, D.K. Odell and D.J. Banowitz. 1992. Trends and patterns in manatee mortality in Florida, 1974-1991 [abstract], p. 22. *In* T.J. O'Shea, B.B. Ackerman and H.F. Percival [eds.] *Interim report of the technical workshop on manatee population biology*. Manatee Population Research Report No. 10. Florida Cooperative Fish and Wildlife Research Unit, University of Florida, Gainesville, FL.
3. Asper, E.D. and S.W. Searles. 1981. Husbandry of injured and orphaned manatees at Sea World of Florida, p. 121-127. *In* R.L. Brownell, Jr. and K. Ralls [eds.] *The West Indian manatee in Florida: proceedings of a workshop held in Orlando, FL, 27-29 March 1978*. Florida Department of Natural Resources, Tallahassee, FL.
4. Baugh, T.M., J.A. Valade and B.J. Zoodsma. 1989. Manatee use of *Spartina alterniflora* in Cumberland Sound. *Marine Mammal Science* 5: 88-90.
5. Beck, C.A. and N.B. Barros. 1991. The impact of debris on the Florida manatee. *Marine Pollution Bulletin* 22: 508-510.
6. Beck, C.A., R.K. Bonde and G.B. Rathbun. 1982. Analyses of propeller wounds on manatees in Florida. *Journal of Wildlife Management* 46: 531-535.
7. Beck, C.A. and D.J. Forrester. 1988. Helminths of the Florida manatee, *Trichechus manatus latirostris*, with a discussion and summary of the parasites of sirenians. *Journal of Parasitology* 74: 628-637.
8. Beck, C.A. and J.P. Reid. 1992. An automated photo-identification catalog for manatee life history studies [abstract], p. 18-19. *In* T.J. O'Shea, B.B. Ackerman and H.F. Percival [eds.] *Interim report of the technical workshop on manatee population biology*. Manatee Population Research Report No. 10. Florida Cooperative Fish and Wildlife Research Unit, University of Florida, Gainesville, FL.
9. Best, R.C. 1981. Foods and feeding habits of wild and captive Sirenia. *Mammal Review* 11: 3-29.
10. Bonde, R.K. (U.S. Fish and Wildlife Service, Denver Wildlife Research Center, Gainesville, FL). 1992. Personal communication.
11. Bonde, R.K., T.J. O'Shea and C.A. Beck. 1983. *Manual of procedures for the salvage and necropsy of carcasses of the West Indian Manatee*

**Chapter 8 (continued)**

- (*Trichechus manatus*). Sirenia Project, U.S. Fish and Wildlife Service, Gainesville, FL. 175 p.
12. Bossart, G. (Miami Seaquarium, Miami, FL). 1991. Personal communication.
  13. Buergelt, C.D. and R.K. Bonde. 1983. Toxoplasmic meningoencephalitis in a West Indian manatee. *Journal of the American Veterinary Medical Association* 183: 1294-1296.
  14. Buergelt, C.D., R.K. Bonde, C.A. Beck and T.J. O'Shea. 1984. Pathologic findings in manatees in Florida. *Journal of the American Veterinary Medical Association* 185: 1331-1334.
  15. Buergelt, C.D., R.K. Bonde, C.A. Beck and T.J. O'Shea. 1990. Myxomatous transformations of heart valves in Florida manatees (*Trichechus manatus latirostris*). *Journal of Zoo and Wildlife Medicine* 21: 220-227.
  16. Campbell, H.W. and A.B. Irvine. 1977. Feeding ecology of the West Indian manatee *Trichechus manatus* Linnaeus. *Aquaculture* 12: 249-251.
  17. Campbell, H.W. and A.B. Irvine. 1981. Manatee mortality during the unusually cold winter of 1976-77, p. 86-91. *In* R.L. Brownell, Jr. and K. Ralls [eds.] *The West Indian manatee in Florida: proceedings of a workshop held in Orlando, FL, 27-29 March 1978*. Florida Department of Natural Resources, Tallahassee, FL.
  18. Florida Department of Natural Resources. 1991. Unpublished statistics.
  19. Gunter, G. and G. Corcoran. 1981. Mississippi manatees. *Gulf Research Reports* 7: 97-99.
  20. Hartman, D.S. 1979. Ecology and behavior of the manatee (*Trichechus manatus*) in Florida. *American Society of Mammalogists, Special Publication No. 5*. 153 p.
  21. Hernandez, P., J.E. Reynolds III, H. Marsh and M. Marmontel. 1992. Age and seasonality in spermatogenesis of Florida manatees [abstract], p. 17. *In* T.J. O'Shea, B.B. Ackerman and H.F. Percival [eds.] *Interim report of the technical workshop on manatee population biology*. Manatee Population Research Report No. 10. Florida Cooperative Fish and Wildlife Research Unit, University of Florida, Gainesville, FL.
  22. Howell, A.B. 1930. *Aquatic mammals: their adaption to life in the water*. Charles C Thomas, Baltimore. 338 p.
  23. Irvine, A.B. 1983. Manatee metabolism and its influence on distribution in Florida. *Biological Conservation* 25: 315-334.
  24. Irvine, A.B. and H.W. Campbell. 1978. Aerial census of the West Indian manatee, *Trichechus manatus*, in the southeastern United States. *Journal of Mammalogy* 59: 613-617.
  25. Irvine, A.B., F.C. Neal, P.T. Cardeilhac, J.A. Popp, F.H. White and R.L. Jenkins. 1980. Clinical observations on captive and free-ranging West Indian manatees, *Trichechus manatus*, in Florida. *Aquatic Mammals* 8: 2-10.
  26. Irvine, A.B. and M.D. Scott. 1984. Development and use of marking techniques to study manatees in Florida. *Florida Scientist* 47: 12-26.
  27. Marmontel, M. 1992. Age and reproductive parameter estimates in

**Chapter 8 (continued)**

- female Florida manatees [abstract], p. 16. *In* T.J. O'Shea, B.B. Ackerman and H.F. Percival [eds.] Interim report of the technical workshop on manatee population biology. Manatee Population Research Report No. 10. Florida Cooperative Fish and Wildlife Research Unit, University of Florida, Gainesville, FL.
28. Medway, W., D.J. Black and G.B. Rathbun. 1982. Hematology of the West Indian manatee (*Trichechus manatus*). *Veterinary Clinical Pathology* 11: 11-15.
  29. Medway, W., M.L. Bruss, J.L. Bengtson and D.J. Black. 1982. Blood chemistry of the West Indian manatee (*Trichechus manatus*). *Journal of Wildlife Diseases* 18: 229-234.
  30. Moore, J.C. 1956. Observations of manatees in aggregations. *American Museum Novitates* 1811: 1-24.
  31. Odell, D.K. 1982. West Indian manatee, p. 828-831. *In* J.A. Chapman and G.A. Feldhamer [eds.] *Wild mammals of North America: biology, management and economics*. Johns Hopkins University Press, Baltimore, MD.
  32. Odell, D. K. and J.E. Reynolds. 1979. Observations on manatee mortality in south Florida. *Journal of Wildlife Management* 43: 572-577.
  33. O'Shea, T.J. 1988. Manatee research efforts under way on Florida's east coast. *Endangered Species Technical Bulletin* 13: 3-4.
  34. O'Shea, T.J. 1988. The past, present, and future of manatees in the southeastern United States: realities, misunderstandings, and enigmas, p. 184-204. *In* R.R. Odom, K.A. Riddleberger and J.C. Ozier [eds.] *Proceedings of the Third Southeastern Nongame and Endangered Wildlife Symposium*. Georgia Department of Natural Resources, Game and Fish Division, Social Circle, GA.
  35. O'Shea, T.J. (U.S. Fish and Wildlife Service, National Ecology Research Center, Fort Collins, CO). 1992. Personal communication.
  36. O'Shea, T.J., C.A. Beck, R.K. Bonde, H.I. Kochman and D.K. Odell. 1985. An analysis of manatee mortality patterns in Florida, 1976-1981. *Journal of Wildlife Management* 49: 1-11.
  37. O'Shea, T.J., G.B. Rathbun, E.D. Asper and S.W. Searles. 1985. Tolerance of West Indian manatees to capture and handling. *Biological Conservation* 33:335-349.
  38. O'Shea, T.J., G.B. Rathbun, R.K. Bonde, C.D. Buergelt and D.K. Odell. 1991. An epizootic of Florida manatees associated with a dinoflagellate bloom. *Marine Mammal Science* 7: 165-179.
  39. Powell, J.A. and G.B. Rathbun. 1984. Distribution and abundance of manatees along the northern coast of the Gulf of Mexico. *Northeast Gulf Science* 7: 1-28.
  40. Powell, J.A. and J.C. Waldron. 1981. The manatee population in Blue Spring, Volusia County, Florida, p. 41-51. *In* R.L. Brownell, Jr. and K. Ralls [eds.] *The West Indian manatee in Florida: proceedings of a workshop held in Orlando, FL, 27-29 March 1978*. Florida Department of Natural Resources, Tallahassee, FL.
  41. Rathbun, G.B., R.K. Bonde and D. Clay. 1982. The status of the West Indian manatee on the Atlantic coast north of Florida, p. 152-165.

**Chapter 8 (continued)**

- In R.R. Odom and J.W. Guthrie [eds.] Proceedings of the Nongame and Endangered Wildlife Symposium, August 13-14, 1981, Athens, GA. Georgia Department of Natural Resources Game and Fish Division, Technical Bulletin WL 5.
42. Rathbun, G.B., J.P. Reid, R.K. Bonde and J.A. Powell. 1992. Reproduction in free-ranging West Indian manatees (*Trichechus manatus*) [abstract], p. 19-20. In T.J. O'Shea, B.B. Ackerman and H.F. Percival [eds.] Interim report of the technical workshop on manatee population biology. Manatee Population Research Report No. 10. Florida Cooperative Fish and Wildlife Research Unit, University of Florida, Gainesville, FL.
  43. Rathbun, G.B., J.P. Reid and G. Carowan. 1990. Distribution and movement patterns of manatees (*Trichechus manatus*) in northwestern peninsular Florida. Florida Marine Research Publication No. 48. 33 p.
  44. Reid, J.P. and T.J. O'Shea. 1989. Three years operational use of satellite telemetry on Florida manatees: tag improvements based on challenges from the field, p. 217-232. In Proceedings of the 1989 North American Argos Users Conference. Service Argos, Inc. Landover, MD. 361 p.
  45. Reid, J.P., G.B. Rathbun and J.R. Wilcox. 1991. Distribution patterns of individually identifiable West Indian manatees (*Trichechus manatus*) in Florida. Marine Mammal Science 7: 180-190.
  46. Reynolds, J.E., III. 1981. Behavior patterns in the West Indian manatee, with emphasis on feeding and diving. Florida Scientist 44: 233-241.
  47. Reynolds, J.E., III. 1981. Manatees of Blue Lagoon Lake, Miami, Florida: biology and effects of man's activities, p. 25-32. In R.L. Brownell, Jr. and K. Ralls [eds.] The West Indian manatee in Florida: proceedings of a workshop held in Orlando, FL, 27-29 March 1978. Florida Department of Natural Resources, Tallahassee, FL.
  48. Reynolds, J.E., III. 1981. Aspects of the social behavior and herd structure of a semi-isolated colony of West Indian manatees, *Trichechus manatus*. Mammalia 45: 431-451.
  49. Reynolds, J.E., III and C.J. Gluckman. 1988. Protection of West Indian manatees (*Trichechus manatus*) in Florida. Final Report to the Marine Mammal Commission, contracts MM4465868-3 and MM3309741-7. Marine Mammal Commission, Washington, DC. 85 p.
  50. Reynolds, J.E., III and J.R. Wilcox. 1985. Abundance of West Indian manatees (*Trichechus manatus*) around selected Florida power plants following winter cold fronts, 1982-1983. Bulletin of Marine Science 36: 413-422.
  51. Scholander, P.F. and L. Irving. 1941. Experimental investigations on the respiration and diving of the Florida manatee. Journal of Cellular and Comparative Physiology 17: 169-191.
  52. Shane, S.H. 1983. Abundance, distribution, and movements of mana-

**Chapter 8 (continued)**

- tees (*Trichechus manatus*) in Brevard County, Florida. Bulletin of Marine Science 33: 1-9.
53. U.S. Fish and Wildlife Service. 1989. Florida manatee (*Trichechus manatus latirostris*) recovery plan. Prepared by the Florida Manatee Recovery Team for the U.S. Fish and Wildlife Service, Atlanta, GA. 98 p.
  54. Walsh, M. (Sea World, Inc., Orlando, FL). 1992. Personal communication.
  55. Watson, A.G. and R.K. Bonde. 1986. Congenital malformations of the flipper in three West Indian manatees, *Trichechus manatus*, and a proposed mechanism for development of ectrodactyly and cleft hand in mammals. Clinical Orthopaedics 202: 294-301.
  56. White, J.R., Harkness, D.R., Isaacks, R.E. and Duffield, D.A. 1976. Some studies on blood of the Florida manatee *Trichechus manatus latirostris*. Comparative Biochemistry and Physiology 55A: 413-417.

**Chapter 9.**

1. Ames, J.A., R.A. Hardy and F.E. Wendell. 1986. A simulated translocation of sea otters, *Enhydra lutris*, with a review of capture, transport, and holding techniques. California Department of Fish and Game, Marine Resources Technical Report No. 52. 17 p.
2. Bayha, K. 1990. USFWS guidelines for capturing and handling sea otters, p. 170-176. In T.M. Williams and R.W. Davis [eds.] Sea otter rehabilitation program: 1989 **Exxon Valdez** oil spill. International Wildlife Research.
3. Bodkin, J.L. and R.J. Jameson. 1991. Patterns of seabird and marine mammal carcass deposition along the central California coast, 1980-1986. Canadian Journal of Zoology 69: 1149-1155.
4. Costa, D.P. 1982. Energy, nitrogen, and electrolyte flux and sea water drinking in the sea otter *Enhydra lutris*. Physiological Zoology 55: 35-44.
5. Costa, D. and G.L. Kooyman. 1982. Oxygen consumption, thermoregulation, and the effect of fur oiling and washing on the sea otter *Enhydra lutris*. Canadian Journal of Zoology 60: 2761-2767.
6. Davis, R.W. 1990. Facilities and organization, p. 3-58. In T.M. Williams and R.W. Davis [eds.] Sea otter rehabilitation program: 1989 **Exxon Valdez** oil spill. International Wildlife Research.
7. Davis, R.W., T.M. Williams, J.A. Thomas, R. Kastelein and L.H. Cornell. 1988. The effects of oil contamination and cleaning on sea otters (*Enhydra lutris*). II. Metabolism, thermoregulation, and behavior. Canadian Journal of Zoology 60: 2782-2790.
8. DeGange, A.R. and M.M. Vacca. 1989. Sea otter mortality at Kodiak Island, Alaska, during summer 1987. Journal of Mammalogy 70: 836-838.
9. Estes, J.A., R.J. Jameson and A.M. Johnson. 1981. Food selection and some foraging tactics of sea otters, p. 606-641. In J.A. Chapman and D. Pursley [eds.] Proceedings of the worldwide furbearers conference, 1980, Frostburg, MD. Vol. 1.

**Chapter 9 (continued)**

10. Estes, J.A., R.J. Jameson, and E.B. Rhode. 1982. Activity and prey selection in the sea otter: influence of population status on community structure. *American Naturalist* 120: 242-258.
11. Faurot, E.R. 1985. Haulout behavior of California sea otters, *Enhydra lutris*. *Marine Mammal Science* 1: 337-339.
12. Garshelis, D.L. and J.A. Garshelis. 1984. Movements and management of sea otters in Alaska. *Journal of Wildlife Management* 48: 665-678.
13. Garshelis, D.L., J.A. Garshelis, and A.T. Kimker. 1986. Sea otter time budgets and prey relationships in Alaska. *Journal of Wildlife Management* 50: 637-647.
14. Geraci, J.R. and T.D. Williams. 1990. Physiologic and toxic effects on sea otters, p. 211-221. *In* J.R. Geraci and D.J. St. Aubin [eds.] *Sea mammals and oil: confronting the risks*. Academic Press, Inc., San Diego, CA.
15. Gerrodette, T. 1983. Review of the California sea otter salvage program. Marine Mammal Commission Report No. MMC-83/02, Marine Mammal Commission, Washington, DC. 23 p.
16. Hill, K.A., F. Weltz, T.P. Monahan and R.W. Davis. 1990. Capture operations, p. 59-81. *In* T.M. Williams and R.W. Davis [eds.] *Sea otter rehabilitation program: 1989 Exxon Valdez oil spill*. International Wildlife Research.
17. Howard, L.D. 1973. Muscular anatomy of the forelimb of the sea otter (*Enhydra lutris*). *Proceedings of the California Academy of Sciences (Series 4)* 39: 411-500.
18. Howell, A.B. 1930. *Aquatic mammals: their adaption to life in the water*. Charles C Thomas, Springfield, IL. 338 p.
19. Hubbs Marine Research Institute. 1986. Introduction, p. 1-4. *In* Sea otter oil spill mitigation study. U.S. Department of Interior, Minerals Management Service, OCS Study MMS 86-0009.
20. Jameson, G.L. 1986. Trial systematic salvage of beach-cast sea otter, *Enhydra lutris*, carcasses in the central and southern portion of the sea otter range in California. National Technical Information Service, Springfield, VA. NTIS PB87-108288. 60 p.
21. Jameson, R.J. (U.S. Fish and Wildlife Service, San Simeon, CA). 1991. Personal communication.
22. Jameson, R.J. 1989. Movements, home range, and territories of male sea otters off central California. *Marine Mammal Science* 5: 159-172.
23. Jameson, R.J., K.W. Kenyon, S. Jeffries and G.R. VanBlaricom. 1986. Status of a translocated sea otter population and its habitat in Washington. *Murrelet* 67: 84-87.
24. Jameson, R.J., K.W. Kenyon, A.M. Johnson, and H.M. Wright. 1982. History and status of translocated sea otter populations in North America. *Wildlife Society Bulletin* 10: 100-107.
25. Kenyon, K.W. 1969. The sea otter in the eastern Pacific Ocean. *North American Fauna*, No. 68. U.S. Fish and Wildlife Service, Washington, DC. 352 p.
26. MacAskie, I. 1987. Updated status of the sea otter, *Enhydra lutris*, in Canada. *Canadian Field Naturalist* 101: 279-283.

**Chapter 9 (continued)**

27. McBain, J. (Sea World, Inc., San Diego, CA). 1992. Personal communication.
28. Monnett, C. and L.M. Rotterman. 1988. Movement patterns of adult female and weanling sea otters in Prince William Sound, Alaska, p. 133-161. *In* D.B. Siniff and K. Ralls [eds.] Population status of sea otters. U.S. Department of Interior, Minerals Management Service, OCS Study MMS 88-002.
29. Morejohn, G.V., J.A. Ames and D.B. Lewis. 1975. Post mortem studies of sea otters, *Enhydra lutris* L., in California. California Department of Fish and Game, Marine Resources Technical Report No. 30. 82 p.
30. Osborn, K. and T.M. Williams. 1990. Postmortem examination of sea otters, p. 134-146. *In* T.M. Williams and R.W. Davis [eds.] Sea otter rehabilitation program: 1989 **Exxon Valdez** oil spill. International Wildlife Research.
31. Payne, S.F. and R.J. Jameson. 1984. Early behavioral development of the sea otter, *Enhydra lutris*. *Journal of Mammalogy* 65: 527-531.
32. Rathbun, G.B., R.J. Jameson, G.R. VanBlaricom, and R.L. Brownell, Jr. 1990. Reintroduction of sea otters to San Nicholas Island, California: preliminary results for the first year, p. 99-113. *In* P.J. Bryant and J. Remington [eds.] Endangered wildlife and habitats in southern California. Memoirs of the Natural History Foundation of Orange County, Newport Beach, CA. Vol. 3.
33. Riedman, M.L. and J.A. Estes. 1990. The sea otter: behavior, ecology, and natural history. U.S. Fish and Wildlife Service, Biological Reports 90(14): 1-126.
34. Rotterman, L.M. and T. Simon-Jackson. 1988. Sea otter, *Enhydra lutris*, p. 237-275. *In* J.W. Lentfer [ed.] Selected marine mammals of Alaska: species accounts with research and management recommendations. National Technical Information Service, Springfield, VA. NTIS PB88-178462.
35. Siniff, D. and Ralls, K. 1991. Reproduction, survival and tag loss in California sea otters. *Marine Mammal Science* 7: 211-229.
36. Stullken, D.E. and C.M. Kirkpatrick. 1955. Physiological investigation of captivity mortality in the sea otter (*Enhydra lutris*). *Transactions of the North American Wildlife Conference* 20: 476-494.
37. Thomas, J.A., L.H. Cornell, B.E. Joseph, T.D. Williams and S. Dreischman. 1987. An implanted transponder chip used as a tag for sea otters (*Enhydra lutris*). *Marine Mammal Science* 3: 271-274.
38. Tuomi, P. 1990. Husbandry, p. 118-133. *In* T.M. Williams and R.W. Davis [eds.] Sea otter rehabilitation program: 1989 **Exxon Valdez** oil spill. International Wildlife Research.
39. U.S. Fish and Wildlife Service. 1982. Southern sea otter recovery plan. U.S. Fish and Wildlife Service, Denver, CO. 66 p.
40. U.S. Fish and Wildlife Service. 1990. Administration of the Marine Mammal Protection Act of 1972: annual report January 1, 1989-December 31, 1989. U.S. Fish and Wildlife Service, Washington, DC. 54 p.

**Chapter 9 (continued)**

41. Wild, P.W. and J.A. Ames. 1974. A report on the sea otter, *Enhydra lutris* L., in California. California Fish and Game Marine Resources Technical Report No. 20. 93 p.
42. Williams, T.D. 1990. Sea otter biology and medicine, p. 625-648. *In* L. Dierauf [ed.] CRC handbook of marine mammal medicine: health, disease, and rehabilitation. CRC Press, Inc., Boca Raton, FL.
43. Williams, T.M. and R.W. Davis. 1990. Summary and recommendations, p. 147-153. *In* T.M. Williams and R.W. Davis [eds.] Sea otter rehabilitation program: 1989 **Exxon Valdez** oil spill. International Wildlife Research.
44. Williams, T.M., R.K. Wilson, T. Tuomi and L. Hunter. 1990. Critical care and toxicological evaluation of sea otters exposed to crude oil, p. 82-100. *In* T.M. Williams and R.W. Davis [eds.] Sea otter rehabilitation program: 1989 **Exxon Valdez** oil spill. International Wildlife Research.
45. Wilson, R.K., P. Tuomi, J.P. Schroeder and T.D. Williams. 1990. Clinical treatment and rehabilitation of oiled sea otters, p. 101-117. *In* T.M. Williams and R.W. Davis [eds.] Sea otter rehabilitation program: 1989 **Exxon Valdez** oil spill. International Wildlife Research.
46. Yohe, E.R. and R.W. Davis. 1986. Transport and temporary holding of sea otters, p. 14-20. *In* Hubbs Marine Research Institute, Sea otter oil spill mitigation study. U.S. Department of Interior, Minerals Management Service, OCS Study MMS 86-0009.
47. Yohe, E.R. and R.W. Davis. 1986. Release of rehabilitated sea otters, p. 107-108. *In* Hubbs Marine Research Institute, Sea otter oil spill mitigation study. U.S. Department of Interior, Minerals Management Service, OCS Study MMS 86-0009.
48. Yohe, E.R., R.W. Davis and J.A. Thomas. 1986. Capture methods for sea otters, p. 5-13. *In* Hubbs Marine Research Institute, Sea otter oil spill mitigation study. U.S. Department of Interior, Minerals Management Service, OCS Study MMS 86-0009.

**Chapter 10.**

1. Aguilar, A. 1985. Compartmentation and reliability of sampling procedures in organochlorine pollution surveys of cetaceans. *Residue Reviews* 95: 91-114.
2. Baden, D. (University of Miami, Miami, FL). 1991. Personal communication.
3. Barabash-Nikiforov, I.I., V.V. Reshetkin and N.K. Shidlovskaya. 1947. The sea otter (Kalan). (Translated by the Israel Program for Scientific Translations.) National Technical Information Service, Springfield, VA. Rep. No. OTS 61-31057.
4. Becker, P.R., S.A. Wise, B.J. Koster and R. Zeisler. 1988. Alaska marine mammal tissue archival project: a project description including collection protocols. U.S. Department of Commerce, National Bureau of Standards, Gaithersburg, MD. NBSIR 88-3750. 46 p.
5. Becker, P.R., S.A. Wise, B.J. Koster and R. Zeisler. 1991. Alaska marine mammal tissue archival project: revised collection protocol.



**Chapter 10 (continued)**

- U.S. Department of Commerce, National Institute of Standards and Technology, Gaithersburg, MD. NISTIR 4529. 33 p.
6. Bonde, R.K., T.J. O'Shea, and C.A. Beck. 1983. Manual of procedures for the salvage and necropsy of carcasses of the West Indian manatee (*Trichechus manatus*). Sirenia Project, U.S. Fish and Wildlife Service, Gainesville, FL. 175 p.
  7. Buck, J.D. and S. Spotte. 1986. The occurrence of potentially pathogenic vibrios in marine mammals. *Marine Mammal Science* 2: 319-324.
  8. Calambokidis, J. (Cascadia Research Collective). 1990. Draft report. Recommended guidelines for sampling marine mammal tissue for chemical analyses in Puget Sound. Prepared for U.S. Environmental Protection Agency, Seattle, WA.
  9. Carter, G.R. and J.R. Cole Jr. [eds.]. 1990. Diagnostic procedures in veterinary bacteriology and mycology. 5th ed. Academic Press, Inc. 620 p.
  10. Cotter, S.M. and J. Blue. 1985. The bone marrow, p. 1199-1204. *In* D.H. Slatter [ed.] Textbook of small animal surgery. W.B. Saunders Co., Philadelphia, PA.
  11. Dailey, M.D. and W.G. Gilmartin. 1980. Diagnostic key to the parasites of some marine mammals. NOSC Technical Document 295. Naval Oceans Systems Center, San Diego, CA. 37 p.
  12. Deiter, R.L. 1991. Recovery and necropsy of marine mammal carcasses in and near the Point Reyes National Seashore, May 1982 - March 1987, p. 123-141. *In* J.E. Reynolds and D.K. Odell [eds.] Marine mammal strandings in the United States: proceedings of the second marine mammal stranding workshop, Miami, FL, Dec. 3-5, 1987. NOAA Technical Report NMFS 98.
  13. Delyamure, S.L. 1968. Helminthofauna of marine mammals (ecology and phylogeny). Akademii Nauk SSSR, Moscow, 1955. (Translated from Russian) U.S. Department of Interior and National Science Foundation, Washington, DC. 522 p.
  14. Dierauf, L.A., D.J. Vandenbroek, J. Roletto and M. Koski. 1985. An epizootic of leptospirosis in California sea lions. *Journal of the American Veterinary Medical Association* 187: 1145-1148.
  15. Domingo, M., L. Ferrer, M. Pumarola, A. Marco, J. Plana, S. Kennedy, M. McAliskey and B.K. Rima. 1990. Morbillivirus in dolphins. *Nature* 348: 21.
  16. Domning, D.P. and A.C. Myrick, Jr. 1980. Tetracycline marking and the possible layering rate of bone in an Amazonian manatee (*Trichechus inunguis*), p. 203-207. *In* W.F. Perrin and A.C. Myrick, Jr. [eds.] Age determination of toothed whales and sirenians. Report of the International Whaling Commission, Special Issue 3. International Whaling Commission, Cambridge, U.K.
  17. Fay, F.H., L.M. Shults and R. A. Dieterich. 1979. A field manual of procedures for postmortem examination of Alaskan marine mammals. Institute of Marine Science and Institute of Arctic Biology, University of Alaska, Fairbanks. 51 p.
  18. Galloway, S.B. (National Marine Fisheries Service, Southeast Fisheries Science Center, Charleston, SC). 1992. Personal communication.

**Chapter 10 (continued)**

19. Garshelis, D.L. 1984. Age estimation of living sea otters. *Journal of Wildlife Management* 48: 456-463.
20. Geraci, J.R. 1981. *Marine mammal care*. 2nd ed. University of Guelph, Guelph, Ont. 98 p.
21. Geraci, J.R. 1989. Clinical investigation of the 1987-88 mass mortality of bottlenose dolphins along the U.S. central and south Atlantic coast. Final report to National Marine Fisheries Service, U.S. Navy (Office of Naval Research) and Marine Mammal Commission. 63 p.
22. Geraci, J.R., D.M. Anderson, R.J. Timperi, D.J. St. Aubin, G.A. Early, J.H. Prescott and C.A. Mayo. 1989. Humpback whales (*Megaptera novaeangliae*) fatally poisoned by dinoflagellate toxin. *Canadian Journal of Fisheries and Aquatic Sciences* 46: 1895-1898.
23. Geraci, J.R. and D.J. St. Aubin. 1979. Stranding workshop summary report: analysis of marine mammal strandings and recommendations for a nationwide stranding salvage program, p. 1-33. *In* J.R. Geraci and D.J. St. Aubin [eds.] *Biology of marine mammals: insights through strandings*. National Technical Information Service, Springfield, VA. NTIS No. PB-293-890.
24. Geraci, J.R. and D.J. St. Aubin. 1987. Effects of parasites on marine mammals. *International Journal of Parasitology* 17: 407-414.
25. Geraci, J.R., D.J. St. Aubin, I.K. Barker, R.G. Webster, V.S. Hinshaw, W.J. Bean, H.L. Ruhnke, J.H. Prescott, G. Early, A.S. Baker, S. Madoff, and R.T. Schooley. 1982. Mass mortality of harbor seals: pneumonia with influenza A virus. *Science* 215: 1129-1131.
26. Geraci, J.R., D.J. St. Aubin and G.A. Early. 1987. Cetacean mass strandings: the study of stress and shock. Abstracts of the 7th Biennial Conference on the Biology of Marine Mammals, Dec. 5-9, 1987, University of Miami, Miami, FL. Society for Marine Mammalogy.
27. Geraci, J.R. and S. Ridgway. 1991. On disease transmission between cetaceans and humans. *Marine Mammal Science* 7: 191-194.
28. Griner, L.A. 1987. Autopsy procedure for pinnipeds and small cetaceans. Appendix G. *In* W.G. Gilmartin, Hawaiian monk seal die-off response plan: a workshop report. National Marine Fisheries Service, Southwest Fisheries Center Administrative Report H-87-19.
29. Hare, M.P. and J.M. Mead. 1987. Handbook for determination of adverse human-marine mammal interactions from necropsies. National Marine Fisheries Service, Northwest and Alaska Fisheries Center Processed Report 87-06. 35 p.
30. Harwood, J. and P. Reijnders. 1988. Seals, sense and sensibility. *New Scientist* 120: 28-29.
31. Helle, E., M. Olsson and S. Jensen. 1976. PCBs correlated with pathological changes in seal uteri. *Ambio* 4: 261-263.
32. Hofman, R.J. 1991. History, goals, and achievements of the regional marine mammal stranding networks in the United States, p. 7-15. *In* J.E. Reynolds and D.K. Odell [eds.] *Marine mammal strandings in the United States: proceedings of the second marine mammal stranding workshop*, Miami, FL, Dec. 3-5, 1987. NOAA Technical Report NMFS 98.

**Chapter 10 (continued)**

33. Jones, T.C., R.D. Hunt and H.A. Smith. 1983. Veterinary pathology. 5th ed. Lea & Febiger, Philadelphia. 1792 p.
34. Klevezal', G.A. and S.E. Kleinenburg. 1967. Age determination of mammals by layered structure in teeth and bone. (Translated from Russian by the Israel Program for Scientific Translations, Jerusalem, 1969.) 128 p.
35. Laws, R.M. and R.J.F. Taylor. 1957. A mass mortality of crabeater seals (*Lobodon carcinophagus* Gray). Proceedings of the Zoological Society of London 129: 315-325.
36. Lennette, E.H., A. Balows, W.J. Hausler Jr. and H.J. Shadomy [eds.]. 1985. Manual of clinical microbiology. American Society for Microbiology, Washington, DC. 1149 p.
37. Lynch, J. (Ontario Ministry of Agriculture and Food, Guelph, Ont.). 1991. Personal communication.
38. Margolis, L. and H.P. Arai. 1989. Synopsis of the parasites of vertebrates of Canada: parasites of marine mammals. Alberta Agriculture Publication. Edmonton, Alberta. 26 p.
39. Margolis, L. and M.D. Dailey. 1972. Revised annotated list of parasites from sea mammals caught off the west coast of North America. NOAA Technical Report NMFS SSRF-647, Seattle, WA. 23 p.
40. McBain, J. (Sea World, Inc., San Diego, CA). 1992. Personal communication.
41. Norris, K.S. 1961. Standardized methods for measuring and recording data on the smaller cetaceans. Journal of Mammalogy 42: 471-476.
42. Odell, D.K., E.D. Asper, J. Baucom and L.H. Cornell. 1980. A recurrent mass stranding of the false killer whale, *Pseudorca crassidens*, in Florida. Fishery Bulletin 78: 171-177.
43. Omura, H. 1963. An approved method for collection of ear plugs from baleen whales. Norsk Hvalfangst-tidende 52: 279-283.
44. Perrin, W.F. and A.C. Myrick, Jr. [eds.]. 1980. Report of the workshop, p. 1-50. In Age determination of toothed whales and sirenians. Report of the International Whaling Commission, Special Issue 3. International Whaling Commission, Cambridge, U.K.
45. Perrin, W.F. and J.E. Powers. 1980. Role of a nematode in natural mortality of spotted dolphins. Journal of Wildlife Management 44: 960-963.
46. Pritchard, M.H. and G.O.W. Kruse. 1982. The collection and preservation of animal parasites. University of Nebraska Press, Lincoln, NB. 141 p.
47. Rausch, R.L. 1953. Studies on the helminth fauna of Alaska XIII: disease in the sea otter, with special reference to helminth parasites. Ecology 34: 584-604.
48. Reijnders, P.H. 1984. Man-induced environmental factors in relation to fertility changes in pinnipeds. Environmental Conservation 11: 61-65.
49. Rommel, S. 1982. Unpublished anatomical drawings of *Tursiops truncatus*.
50. Rommel, S. 1990. Unpublished anatomical drawings of *Phoca vitulina* and *Tursiops truncatus*.

**Chapter 10 (continued)**

51. Scheffer, V.B. 1967. Standard measurements of seals. *Journal of Mammalogy* 48: 459-467.
52. Scheffer, V.B. and B. Kraus. 1964. Dentition of the northern fur seal. *Fishery Bulletin* 63: 293-342.
53. Smith, A.W., N.A. Vedros, T.G. Akers and W.G. Gilmartin. 1978. Hazards of disease transfer from marine mammals to land mammals: review and recent findings. *Journal of the American Veterinary Medical Association* 173: 1131-1133.
54. Soulsby, E.J.L. and H.O. Monnig. 1982. Helminths, arthropods and protozoa of domesticated animals. 7th ed. Lea & Febiger, Philadelphia. 809 p.
55. Stoskopf, M.K. and D.H. Herbert. 1990. Selected anatomical features of the sea otter (*Enhydra lutris*). *Journal of Zoo and Wildlife Medicine* 21: 36-47.
56. Sweeney, J.C. 1990. Surgery in marine mammals, p. 215-233. *In* L.A. Dierauf [ed.] CRC handbook of marine mammal medicine: health, disease, and rehabilitation. CRC Press, Boca Raton, FL.
57. Van Bresseem, M.F., I.K.G. Visser, M.W.G. Van De Bildt, J.S. Teppema, J.A. Raga and A.D.M.E. Osterhaus. 1991. Morbillivirus infection in Mediterranean striped dolphins (*Stenella coeruleoalba*). *Veterinary Record* 129: 471-472.
58. Walsh, M.T., D.O. Beusse, W.G. Young, J.D. Lynch, E.D. Asper and D.K. Odell. 1991. Medical findings in a mass stranding of pilot whales (*Globicephala macrorhynchus*) in Florida, p. 75-83. *In* J.E. Reynolds and D.K. Odell [eds.] Marine mammal strandings in the United States: proceedings of the second marine mammal stranding workshop, Miami, FL, Dec. 3-5, 1987. NOAA Technical Report NMFS 98.
59. Webster, R.G., J.R. Geraci, G. Petursson and K. Skirnisson. 1981. Conjunctivitis in human beings caused by influenza A virus of seals. *New England Journal of Medicine* 304: 911.
60. White, B.N. (Department of Biology, McMaster University, Hamilton, Ont.). 1992. Personal communication.
61. Wilcock, B. (Ontario Veterinary College, University of Guelph, Guelph, Ont.). 1992. Personal communication.
62. Wilkinson, D.M. (U.S. National Marine Fisheries Service, Office of Protected Resources, Silver Spring, MD). 1991. Personal communication.
63. Williams, T. 1990. Sea otter biology and medicine, p. 625-648. *In* L.A. Dierauf [ed.] CRC handbook of marine mammal medicine: health, disease, and rehabilitation. CRC Press, Inc., Boca Raton, FL.
64. Williamson, G.R. 1973. Counting and measuring baleen and ventral grooves of whales. *Scientific Reports of the Whales Research Institute (Tokyo)* 25: 279-292.
65. Winchell, J.M. 1990. Field manual for phocid necropsies (specifically *Monachus monachus*). NOAA Technical Memorandum NOAA-TM-NMFS-SWFC-146. 55 p.

**Chapter 11.**

1. Barry, D. 1991. Moby Yuck, pp. 21-24. *In* Dave Barry Talks Back. Crown Publications, Inc., New York, NY.
2. Best, P.B. (Marine Mammal Research Institute, University of Cape Town, Cape Town, South Africa). 1992. Personal communication.
3. Bonde, R.K. (National Ecology Center, U.S. Fish and Wildlife Service, Gainesville, FL). 1992. Personal communication.
4. Brownell, R.L., Jr. 1992. (U.S. State Department, Washington, D.C.). Personal communication.
5. Early, G.A. (New England Aquarium, Boston, MA). 1992. Personal communication.
6. Heyning, J.E. (Section of Birds and Mammals, Natural History Museum of L.A. County, Los Angeles, CA). 1992. Personal communication.
7. Lopez, B. 1989. A presentation of whales, pp.117-146. *In* Crossing Open Ground. Vantage Books, New York, NY.
8. Marsh, H. (College of Biological Sciences, James Cook University of N. Queensland, Queensland, Australia). 1992. Personal communication.
9. Mead, J.G. (Section of Marine Mammals, Smithsonian Institution, Washington, DC). 1992. Personal communication.
10. Murphy, T. (South Carolina Wildlife and Marine Resources Department, Charleston, SC). 1992. Personal communication.
11. Odell, D.K. (Sea World, Inc., Orlando, FL). 1992. Personal communication.
12. Perrin, W. F. (U.S. National Marine Fisheries Service, Southwest Region, La Jolla, CA). 1992. Personal communication.
13. Royal Society for the Prevention of Cruelty to Animals. 1985. Report of stranded whale workshop: a practical and humanitarian approach. R.S.P.C.A., Horsham (U.K.). 64 p.
14. Smith, T.G. (Pacific Biological Station, Department of Fisheries and Oceans, Nanaimo, B.C.). 1992. Personal communication.
15. Stein, D.L. 1988. A whale of a tale: George H. Newton and the cruise of the Inland Whaling Association. The Log of Mystic Seaport. Vol. 40(2): 39-49. Mystic Seaport Museum, Inc., Mystic, CT.
16. Wilkinson, D.M. 1991. Report to: Assistant Administrator for Fisheries. Program review of the marine mammal stranding networks. U.S. Dept. Commerce, NOAA. 171 p.

**Chapter 12.**

1. Anon. 1992. EPI North: The Northwest Territories Epidemiology Newsletter 4(7): 1-4.
2. Bangs, C. and M.P. Hamlet. 1983. Hypothermia and cold injuries, p. 27-63. *In* P.S. Auerbach and E.C. Geehr [eds.] Management of wilderness and environmental emergencies. Macmillan Publishing Company, New York, NY.
3. Beck, B. and T.G. Smith. 1977. Letter: Seal finger: an unsolved medical problem in Canada. Canadian Medical Association Journal 115: 105-106.
4. Buck, C.D. and J.P. Schroeder. 1990. Public health significance of marine mammal disease, p. 163-173. *In* L.A. Dierauf [ed.] Handbook of

**Chapter 12 (continued)**

- marine mammal medicine: health, disease, and rehabilitation. CRC Press, Boca Raton, FL.
5. Cates, M.B., L. Kaufman, J.H. Grabau, J. Pletcher and J.P. Schroeder. 1986. Blastomycosis in an Atlantic bottlenose dolphin, *Journal of the American Veterinary Medical Association* 189: 1148.
  6. Dierauf, L.A., D.J. Vandenbroek, J. Roletto, M. Koski, L. Amaya and L.J. Gage. 1985. An epizootic of leptospirosis in California sea lions. *Journal of the American Veterinary Medical Association* 187: 1145-1148.
  7. Early, G.A. (New England Aquarium, Boston, MA). 1991. Personal communication.
  8. Flowers, D.J. 1970. Human infection due to *Mycobacterium marinum* after a dolphin bite. *Journal of Clinical Pathology (London)* 23: 475-477.
  9. Geraci, J.R. and S.H. Ridgway. 1991. On disease transmission between cetaceans and humans. *Marine Mammal Science* 7: 191-194.
  10. Hayward, J.S. 1983. The physiology of immersion hypothermia, p. 3-19. *In* R.S. Pozos and L.E. Wittmers [eds.] *The nature and treatment of hypothermia*. University of Minnesota Press, Minneapolis, MN.
  11. Hicks, B.D. and G.A.J. Worthy. 1987. Sealpox in captive grey seals (*Halichoerus grypus*) and their handlers. *Journal of Wildlife Diseases* 23: 1-6.
  12. Howard, E.B., J.O. Britt, Jr., G.K. Matsumoto, R. Itahara and C.N. Nagano. 1983. Bacterial diseases, p. 69-118. *In* E.B. Howard [ed.] *Pathobiology of marine mammal diseases*. Vol. 1. CRC Press, Inc., Boca Raton, FL.
  13. Madoff, S., K. Ruoff and A.S. Baker. 1991. Isolation of a *Mycoplasma* species from a case of Seal Finger. *American Society for Microbiology, Abstracts of the 91st Meeting*.
  14. Marine Mammal Center. 1987. Public health guidelines for the California Marine Mammal Center. Unpublished protocol for handling of stranded animals. Marine Mammal Center, Sausalito, CA. 5 p.
  15. Nakajima, M. and I. Takikawa. 1961. Swine erysipelas in the dolphins (translated from Japanese). *Journal of the Japanese Association of Zoological Gardens and Aquariums* 3: 69-73.
  16. Odegaard, O.A. and J. Krogsrud. 1981. Rabies in Svalbard: infection diagnosed in arctic fox, reindeer and seal. *Veterinary Record* 109: 141-142.
  17. Smith, A.W., D.E. Skilling, J.E. Barlough and E.S. Berry. 1986. Distribution in the North Pacific Ocean, Bering Sea, and Arctic Ocean of animal populations known to carry pathogenic caliciviruses. *Diseases of Aquatic Organisms* 2: 73-80.
  18. Smith, A.W., N.A. Vedros, T.G. Akers and W.G. Gilmartin. 1978. Hazards of disease transfer from marine mammals to land mammals: review and recent findings. *Journal of the American Veterinary Medical Association* 173: 1131-1133.
  19. Suer, L.D. and N.A. Vedros. 1988. *Erysipelothrix rhusiopathiae*. I. Isolation and characterization from pinnipeds and bite/abrasion wounds in humans. *Diseases of Aquatic Organisms* 5: 1-5.

**Chapter 12 (continued)**

20. Symmers, W. St. C. 1983. A possible case of Lobo's disease acquired in Europe from a bottlenose dolphin (*Tursiops truncatus*). Bulletin de la Société de Pathologie Exotique 76: 777-784.
21. Webster, R.G., J. Geraci and G. Petursson. 1981. Conjunctivitis in human beings caused by influenza A virus of seals. New England Journal of Medicine 304: 911.

## Appendix A

# Suggested Field Equipment

### Animal Relief

Zinc oxide  
Blankets and towels  
Shovel (to dig pits for fins and tail)  
Ice packs (to keep extremities cool)  
Tarpaulins  
Foam mattresses  
Water sprayers  
Inflatable rafts  
Thermal "Space" blankets (for warming or cooling)

### Blood and Fluid sampling

Syringes:  
5, 10, 20, 60 ml disposable  
Syringe needles:  
14, 18, 22, 25 gauge bevel tip  
1", 1.5", 2", 3" (2.5, 4, 5, 7.5 cm) needles  
Vacutainer needle holders  
Vacutainer needles  
Blood tubes:  
EDTA  
Heparin  
Plain  
Microhematocrit  
Screw cap vials for plasma/serum  
Pasteur pipettes, 6" (15 cm)  
Wood application sticks  
Pre-soaked alcohol swabs  
Flexible tubing (extension sets)  
Microscope slides and covers

### Buckets (numerous)

For washing, rinsing, carrying specimens and materials  
Container for used needles and blades (plastic bleach bottle)

### Check lists

Telephone  
Equipment  
Task outlines (see 2.4)  
This Field Guide

Marine Mammal Fact sheets (see Fig. 3.1)

### Emergency Medical Supplies

I.V. fluids and infusion sets (droppers, 10 & 60 drop/min.)  
Stimulants  
Tranquilizers  
Adrenalin  
Antibiotics  
Steroids  
Tranquilizer dart pistol (for restraint)

### Euthanasia

Customized needles for whales (see 6.12)  
Euthanasia solutions  
Other euthanasia equipment (see 5.11 and 6.12)

### Forceps

4 1/2" (11 cm) tissue  
4 1/2" (11 cm) fine splinter  
5 1/2" (14 cm) straight Kelly (serrated jaws, box lock joint)  
Jeweler's

### Gloves

Latex dish gloves  
Disposable surgical  
Heavy leather  
Powder-free (for toxicology)

### Hooks

5 1/2" (14 cm) shank bailing  
Long handle logging

### Knives

6" (15 cm) blade steel boning  
6" (15 cm) titanium

### Marking/Labeling

Labels for sample jars  
Markable waterproof labels for placing in jars with preserved tissues



**Suggested Field Equipment (continued)****Marking/Labeling (continued)**

Colored plastic tape for animal identification, triage, etc.  
String, for attaching labels

**Measuring Equipment**

Tapes, 10 m (30 ft) and 30 m (100 ft) waterproof, non-metallic  
Ruler, rigid 12" (30 cm) (to measure blubber thickness)

**Microbiology**

Alcohol, 70 % dilution  
Culture vials - bacterial  
Culture vials - viral  
Swabs, sterile  
Bacterial transport medium  
Viral transport medium  
Spatula and butane lighter, for searing tissue surfaces

**Personal**

First-Aid kit  
Hand soap & towels  
Protective wear ("foul-weather" gear)  
Hats and boots  
Surgical masks  
Disposable coveralls  
Chemical lights ("Cyalumes")  
Flashlights, extra batteries  
Refreshments

**Recording**

Metal clipboards  
Life history forms  
Collection protocol forms  
Waterproof markers  
Camera and film in waterproof carrier

**Restraint/Transport/Tagging**

Kennels (for immobilizing or transporting small pinnipeds or sea otters)  
Nets  
Stretchers (for transporting small cetaceans)  
"Cap-chur" dart pistol (for restraint)

**Restraint/Transport(continued)**

Plastic tags ("Roto tags") and pliers (for tagging small cetaceans through dorsal fin and pinnipeds and otters through flipper web)  
Logging chain with hooks or heavy rope (for towing)

**Saws**

25" (64 cm) butcher hand saw  
12" (30 cm) hacksaw  
Spare blades

**Scalpel**

Handles, sizes 3 & 4  
Blades, #10 & #22

**Scissors**

5 1/2" (14 cm) straight blade operating (sharp and blunt tip)  
6" (15 cm) straight blade dissecting (sharp and blunt tip)  
7" (18 cm) straight blade doyen (abdominal)

**Sharpeners**

14" (36 cm) round steel  
Oil stones, coarse and fine

**Shears**

1 1/8" blade cartilage and bone  
Long handle pruning

**Spring scales**

100 g, 1 kg, 10 kg

**Storing/Preserving**

Gross preservation:  
Formaldehyde, 37 % (dilute on-site to a 10 % formalin solution)  
Histopathology:  
10 % neutral buffered formalin  
Glycerin (5%) in 70 % Ethanol  
70 % Ethanol (see 10.8)  
AFA Fixative (see Fig. 10.33)  
Formol-urea or saturated NaCl (see 10.8)





Appendix B  
**Sample Necropsy Report Form**

Field Number: \_\_\_\_\_ Accession Number: \_\_\_\_\_ Date: \_\_\_\_\_

Species: \_\_\_\_\_ Sex: \_\_\_\_\_ Length: \_\_\_\_\_

Weight: \_\_\_\_\_ Age: \_\_\_\_\_ Prosectors: \_\_\_\_\_

Brief History: (Date of Death: \_\_\_\_\_ )

---

Tentative Diagnosis

---

Final Diagnosis

---

**MEASUREMENTS** (cm unless indicated) \* = Required

**CETACEANS**

- \* Snout to melon: \_\_\_\_\_
- Snout to angle of mouth \_\_\_\_\_
- \* Snout to blowhole \_\_\_\_\_
- Snout to center of eye \_\_\_\_\_
- Snout to fin tip: \_\_\_\_\_
- Snout to fluke notch: \_\_\_\_\_
- Snout to caudal end of ventral grooves: \_\_\_\_\_
- \* Snout to center of anus: \_\_\_\_\_
- Snout to center of genital aperture: \_\_\_\_\_
- \* Snout to ant. insertion of flipper: \_\_\_\_\_
- Snout to ant. insertion of fin: \_\_\_\_\_
- \* Flipper length: \_\_\_\_\_
- \* Flipper width: \_\_\_\_\_
- \* Fin Height: \_\_\_\_\_

**Sample Necropsy Report Form** (continued)**MEASUREMENTS** (cm unless indicated) \* = Required**PINNIPEDS** \_\_\_\_\_ **DIAGRAM**

\* Standard length \_\_\_\_\_

Curvilinear length \_\_\_\_\_

\* Ant. length, front flipper \_\_\_\_\_

\* Ant. length, hind flipper \_\_\_\_\_

Girth: \*Axillary \_\_\_\_\_ Max (location) \_\_\_\_\_ Anal \_\_\_\_\_

Blubber Thickness (excluding epidermis) location \_\_\_\_\_

Dorsal \_\_\_\_\_ Lateral \_\_\_\_\_ \*Ventral \_\_\_\_\_

**Baleen / Tooth Counts****UL** \_\_\_\_\_ **LL** \_\_\_\_\_ **UR** \_\_\_\_\_ **LR** \_\_\_\_\_**CONDITION:** Alive / Freshly dead / Moderately Decomposed / Extremely Decomposed / Other**EXTERNAL EXAMINATION**

General condition: (lesions, deformities, appearance)

Parasites:

Mouth / Teeth:

**PRIMARY INCISION**

Blubber:

Thorax:

Abdomen:

**MUSCULOSKELETAL**

Muscle:

Skeletal:

Vertebral epiphyses:

open \_\_\_\_\_ mm /closed, visible \_\_\_\_\_ /closed, invisible \_\_\_\_\_

**Sample Necropsy Report Form** (continued)

---

**RESPIRATORY**

Upper:  
Lower:  
Cranial Sinuses:

---

**CIRCULATORY**

Heart:  
Great Vessels:  
Blood:

---

**LYMPHATIC**

Spleen:  
L.N.:  
Thymus:

---

**URINARY**

R. Kidney:  
L. Kidney:  
Bladder: (empty / full / urine saved)

---

**ENDOCRINE**

R. Adrenal:  
L. Adrenal:  
Thyroid:  
Pituitary:

---

**DIGESTIVE**

Stomach:  
Stomach contents:  
Intestines: (Length \_\_\_\_\_ M)  
Fecal exam:  
Liver:  
Pancreas:  
Gall bladder / Hepatopancreatic duct:

---

**Sample Necropsy Report Form (continued)**

---

**REPRODUCTIVE**

R. Gonad:

L. Gonad:

Sperm / Corpora:

Penis:

Uterus: (vaginal mucus: **Y N** )R. Mammary: (milk saved **Y N** )L. Mammary: (milk saved **Y N** )

Reproductive Condition:

Pregnant / Fetus: (Sex = \_\_\_\_\_, Weight = \_\_\_\_\_, Length = \_\_\_\_\_)

Lactating:

---

**NERVOUS / SENSORY**

Eyes:

Spinal cord:

Peripheral:

Brain:

Ear sinuses: (parasites)

---



Appendix C  
**Sample Telephone Directory for Strandings**

1. Local Police:

---

2. Local Stranding Network and/or Aquatic Animal Care Facility:

---

3. Regional Office of National Marine Fisheries Service / U.S. Fish and Wildlife Service/State Fish and Game/ Department of Fisheries and Oceans (Canadian):

---

4. Regional Level Agencies (State Parks or Seashores):

---

5. Local Hospital or Veterinary Clinic:

---

6. Coast Guard:

---

7. Media contacts (only persons with specialized training in media relations should be assigned to this task):

---

8. Local landfill or dump-site:

---





# Subject Index<sup>1</sup>

- Age determination. *See* Life history
- Anatomy  
cetacean, 71-73, **73**, **195**, **199**, **203**  
manatee, 145, **146**, **193**  
pinniped, 35-36, **37**, **192**  
sea otter, **160**, **194**
- Approaching stranded animals, 47, 83, 154, 165-166
- Baleen, counting and measuring, 202, **203**
- Beaching vs. stranding, 2-3
- Biology  
adaptations to aquatic environment, 1-2  
of cetaceans, 71-75, 104-131  
of manatees, 145-149  
of pinnipeds, 35-38, 57-69  
of sea otters, 159-162
- Biotoxins  
mortality from, 41, 77, 150, 152, 153, 163  
sample collection, 205-211, **210**
- Blood sampling, 157, 176, **178**, **179**, **180**, **181**, 200-201  
protocol for specimen collection, 200-201
- Blubber  
functions of, 2  
measuring thickness, **190**, 202  
samples for biotoxin analysis, 208, **210**  
samples for contaminant analysis, 206, **207**, **209**  
sampling procedure, **208**
- Capture. *See* Handling
- Carcass disposal, 229-238
- Carcass evaluation, codes for specimen collection, 182-184
- Carcass examination, 187-199, 290-294  
external, 187-190, **191**  
internal, 190-199, **192**, **193**, **194**, **195**, **199**, **218**
- Coast Guard, role of, 9
- Communications, 18, 295
- Contaminants  
effects of, 43, 78  
protocol for sample collection, 205-211, **207**, **209**
- Coordinators, roles of, 17-18, 20, 22, 24, 138-139, 244
- Criteria  
for making decisions, 28-32, **29**  
for release, 32, 54, 56, 99-100, 140-141, 157, 173
- Crowd management, 22-23
- Data collection  
after the event, 245-246  
in mass strandings, 141-143  
requirements, 5, 175-176, *177-178*
- Decomposition of carcass, 182-184
- Disease  
and natural mortality, 41-42, 77, 81, 150, 163  
need for quarantine, 54  
transmissible, 239, 240-241
- Dissection, 187-199, **192**, **193**, **194**, **195**, **199**. *See also* Carcass examination.
- Distribution in U.S. and adjacent waters  
cetacean, 75-76, 104-131  
manatee, 146-149, **147**  
pinniped, 38-40, 57-69  
sea otter, 162-163, **161**
- DNA analysis, samples for, 203, 204
- Education, 11-12, 20, **21**
- Endangered Species Act of 1973, 44, 80, 151, 164
- Entanglement, 43, 77-78, 151, 163
- Environmental conditions  
as criteria for making decisions, 30-31  
effects on stranded cetaceans, 85-87  
and natural mortality, 40, 77, 150, 163
- Equipment. *See* Logistic support
- Euthanasia  
attitudes and issues, 23, 33-34, 100-101  
of cetaceans, 100-103, 141-142

<sup>1</sup>Boldface entries indicate figures; entries in italics indicate tables.

- of manatees, 157
  - as an option, 33-34
  - of pinnipeds, 56
  - of sea otters, 174
- Evaluating the event
  - criteria for making decisions, 28-32, **29**
  - need for intervention, 27-28, 45, 80-82, 152-154, 165
  - options, 28, **29**, 32-34, 140-141
- Exposure. *See* Hyperthermia; Hypothermia
- Financial responsibility, 246
- First aid - determining condition
  - of cetaceans, 80, 83-84, 140
  - of manatees, 152-154, 156-157
  - of pinnipeds, 50, 52
  - of sea otters, 169-170, **170**
- First aid - supportive care
  - of cetaceans, 84-88, **85**, 94-95, 98-99, 140
  - of manatees, 156-157
  - of pinnipeds, 50, 52-54
  - of sea otters, 170-172
- Fish and Wildlife Service, jurisdiction, 8, 45, 149, 152, 164
- Gross and histopathology
  - protocol for sample collection, 216-218, **218**, **219**
- Handling. *See also* Transport
  - cetaceans, 88-92, **89**, **90**, **91**, 140
  - in the water, **81**, 94-97, **94**, **96**, 98, 139, 140-141
  - ease, as criteria for making decisions, 32
  - manatees, 154, **155**, **158**
  - pinnipeds, 47-50, **48**, **49**
  - sea otters, 165-168, **169**
- Health and safety of response team, 30-31, 47, 83, 154, 166, 176, 239-244
- Health of stranded animals. *See also* First Aid
  - as criteria for making decisions, 31-32
- Herding cetaceans, 95-96
- Hyperthermia
  - protecting personnel from, 241
  - in stranded animals, 30, 52, 85-87, 156, **170**, 171
- Hypothermia
  - in personnel, 241-242, 244
  - in strandlings, 30-31, 84, 86, 87, 156, 157, 170, **170**, 171
- Identification of marine mammal species, 57-69, 104-131, 149, 162
- Injuries to team members. *See* Health and Safety
- Legislation protecting marine mammals, 5, 7-8, 44-45, 79, 151-152, 164
- Life history. *See also* Carcass examination
  - protocol for sample collection, 202-205
  - samples for, 177, 186, 196, 197, 198, 199
- Logistic support
  - as criteria for making decisions, 29
  - equipment, 13-14, 45, 47, 82-83, 154, 165, 287-289
  - for lifting and moving cetaceans, 88, **91**, 92, 96-97, 140
  - planning for safety, 243-244
  - for working in water, 241-242, 243, 244
- Marine Mammal Commission, 5
- Marine Mammal Protection Act of 1972, 5, 7, 44, 79-80, 151, 164
- Mass die-off, definition of, 3
- Mass strandings, 133-144
  - definition of, 2-3, 133
- Measurements. *See* Morphometrics
- Media relations, 18, 23-25, 247
- Microbiology
  - protocol for sample collection, 211-216, **213**, **214**, **215**
  - samples from live animals, 176, **178**, 186-187
- Monitoring released animals, 54-56, **55**, 92-94, **93**, 97, 143-144, 157, 173
- Morphometrics, 187, **188**, **189**, **190**, **194**
  - protocol, 201-202
- Mortality - natural
  - of cetaceans, 76-77
  - of manatees, 149-150
  - of pinnipeds 40-42
  - of sea otters, 163

- Mortality - human-related  
of cetaceans, 77-78  
examining for signs of, 187, 189  
of manatees, 150-151  
of pinnipeds, 42-43  
of sea otters, 163
- National Biomonitoring Specimen Bank, 206, **207**, 208-209, 211
- National Institute of Standards and Technology, 6, 206
- National Marine Fisheries Service  
administrative regions, 6, 7, **8**  
jurisdiction, 8, 45, 79
- Necropsy. *See* Carcass examination
- Nutrition during rehabilitation, 53, 99, 157, 172
- Oil spills  
effects on marine mammals, 43, 78, 163, 172  
rehabilitation of oiled otters, 30, 172-173
- Operations Center, role and responsibilities, 9-10
- Organizing, 7-18  
the media, 23-24  
the operations center, 9-10  
the response, 14-18, 138-139  
the response team, 10-12  
specimen and data collection at mass strandings, 142-143
- Packaging and shipping samples, 225-228, **227**, **228**. *See also* Biotoxins; Contaminants; Gross and histopathology; Life history; Microbiology; Parasites.
- Parasites  
of cetaceans, 72, 77, 81, 136, **222**, **223**  
of manatees, 150, **224**  
of pinnipeds, 41, 54, **220**, **221**  
protocol for sample collection 218-222, **225**, **226**  
of sea otters, **224**
- Pathology. *See* Gross and histopathology
- Photographs. *See also* Data collection for identification catalogues, 148-149, 176, 187
- Predation, 41, 163
- Protocols for specimen and data collection  
blood studies, **179-181**, 200-201  
contaminants and biotoxins, 205-211, **207**, **209**, **210**  
examining the carcass, 187-199  
general considerations, 175-176, 177-178, **178**, 185, 186-187  
gross and histopathology, **191**, 216-218, **219**  
life history, 202-205  
microbiology, 211-216, **213**, **214**  
morphometrics, **188**, **189**, **190**, **194**, 201-202  
packaging and shipping, 225-228  
parasitology, 218, 220-224, **225**, **226**  
sample necropsy form, 290-294  
skeletal preparations, 223
- Public attitudes, 3-5, 19, 22-23, 25, 34, 79, 247
- Public health. *See* Health and safety
- Regulatory authorities, 5-6, 7-9, 14-16, 44-45, 79, 151-152, 164
- Rehabilitation  
of cetaceans, 98-99  
of manatees, 156-157  
as an option, 33  
of pinnipeds, 52-54  
of sea otters, 171-173
- Release  
effects on populations, 4  
following recovery, 54-56, 99-100, 157, 173  
immediate, 32-33, 51, 92-97, 140-141, 157, 173
- Response team  
protecting health and safety of, 239-244  
responsibilities, recruiting and training, 11-12
- Safety. *See* Health and safety
- Samples. *See also* Packaging and shipping; Protocols for specimen and data collection  
organizing and tracing, 142-143, 246
- Sampling. *See* Protocols for specimen

- and data collection; Specimen collection
- Shock. *See* Stress and shock
- Skeletal specimens, 198, 223
- Smithsonian Institution, 4, 6
- Social needs of strandlings
  - during rehabilitation, 98, 99, 141, 171-172
  - for release, 92, 139, 140-141
- Social organization, as factor in stranding, 136-138
- Specimen collection. *See also*
  - Protocols for specimen and data collection
  - and carcass quality, 183-184
  - during dissection, general procedures, 185, 186-187, 187-199
  - from live animals, 176, **178**
  - in mass strandings, 142-143
- Stomach contents, collection of, 196, 204-205
- Stranding, definition of, 2-3
- Stranding, measures to avert, 80, **81**, 139-140
- Stranding patterns
  - cetaceans, 78-79, 104-131
  - manatees, 153-154
  - pinnipeds, 43-44, 57-69
  - sea otters, 165
- Stranding networks, development and goals, 5-6, 7
- Stranding theories, 133-138
- Strandings, scientific value of, 3-4
- Stress and shock, 2, 31, 41, 87-88, 99, 156, 163, 165-166, 171, 172 and restranding, 138
- Tagging, **55**, 56, 92-94, **93**, 97, 140, 157, 173
  - natural marks, 94, 176, 187
- Towing cetaceans, 95-96, **81**, **96**
- Toxicology. *See* Contaminants; Biotoxins
- Training, 11-12, 243-244
- Transport
  - of cetaceans, **91**, 96-98, 141
  - of manatees, **155**, 156, **158**
  - of pinnipeds, 51-52
  - of sea otters, 168, 171
- Volunteers, 11-12, 19-20, 139
- Weight, estimating, **46**, **82**
- Zoogeographic regions, 7, **8**
  - stranding patterns in, 57-69, 104-131, 149, 162

## Species Index

- Arctocephalus townsendi*. See  
Guadalupe fur seal
- Atlantic spotted dolphin (*Stenella  
frontalis*), 131, **131**, 133
- Atlantic white-sided dolphin  
(*Lagenorhynchus acutus*), 75, 79,  
125, **125**, 133
- Baird's beaked whale (*Berardius  
bairdii*), 114, **114**
- Balaena mysticetus*. See Bowhead  
whale
- Balaenidae*, 104
- Balaenoptera borealis*. See Sei  
whale
- Balaenoptera musculus*. See Blue  
whale
- Balaenoptera physalus*. See Fin  
whale
- Balaenoptera acutorostrata*. See  
Minke whale
- Balaenoptera edeni*. See Bryde's whale
- Balaenopteridae*, 107
- Beaked whales, 75, 113
- Bearded seal (*Erignathus barbatus*),  
36, 38, 39, 67, **67**, 199
- Beluga whale (*Delphinapterus  
leucas*), 75-76, 77, 79, 88, 118,  
**118**, 137
- Berardius bairdii*. See Baird's beaked  
whale
- Blainville's beaked whale (*Mesoplodon  
densirostris*), 116, **116**
- Blue whale (*Balaenoptera muscu-  
lus*), 76, 108, **108**, 235
- Bottlenose dolphin (*Tursiops  
truncatus*), 75, 76, 77, 78, 79, 81,  
83, 84, 88, 97, 98, 99, 127, **127**,  
133, 134-135, 136
- Bowhead whale (*Balaena  
mysticetus*), 75, 76, 77, 105, **105**
- Bryde's whale (*Balaenoptera  
borealis*), 80, 110, **110**
- California sea lion (*Zalophus  
californianus*), 4, 27, 38, 41, 43,  
53, 60, **60**, 241
- Callorhinus ursinus*. See Northern fur  
seal
- Cape fur seal (*Arctocephalus  
pusillus*), 41
- Cetacea*, 71, 104
- Clymene dolphin (*Stenella clymene*),  
129, **129**
- Common dolphin (*Delphinus  
delphis*), 77, 81, 98, 128, **128**, 133
- Crabeater seal (*Lobodon  
carcinophagus*), 42
- Cuvier's beaked whale (*Ziphius  
cavirostris*), 95, 102, 113, **113**
- Cystophora cristata*. See Hooded  
seal
- Dall's porpoise (*Phocoenoides dalli*),  
120, **120**
- Delphinapterus leucas*. See Beluga  
whale
- Delphinidae*, 121
- Delphinus delphis*. See Common  
dolphin
- Dwarf sperm whale (*Kogia simus*),  
73, 75, 112, **112**
- Enhydra lutris*. See Sea otter
- Erignathus barbatus*. See Bearded seal
- Eschrichtiidae*, 106
- Eschrichtius robustus*. See Gray whale
- Eubalaena glacialis*. See Northern  
right whale
- Eumetopias jubatus*. See Steller sea  
lion
- False killer whale (*Pseudorca  
crassidens*), 74, 94, 122, **122**, 133,  
136
- Feresa attenuata*. See Pygmy killer  
whale
- Fin whale (*Balaenoptera physalus*),  
75, 76, 84, 101, 108, **108**, 230-231
- Fraser's dolphin (*Lagenodelphis  
hosei*), 126, **126**
- Galapagos fur seal (*Arctocephalus  
galapagoensis*), 40
- Galapagos sea lion (*Zalophus  
californianus wollebaekii*), 40, 42
- Gervais' beaked whale (*Mesoplodon*

- europaeus*), 117, **117**  
 Ginko-toothed beaked whale  
 (*Mesoplodon ginkodens*), 118  
*Globicephala macrorhynchus* See  
 Short-finned pilot whale  
*Globicephala melas*. See Long-  
 finned pilot whale  
*Grampus griseus*. See Risso's  
 dolphin  
 Gray seal (*Halichoerus grypus*), 38,  
 40-41, 48, 50, 66, **66**  
 Gray whale (*Eschrichtius robustus*),  
 23, 75, 76, 77, 78, 79, 106, **106**,  
 135  
 Guadalupe fur seal (*Arctocephalus*  
*townsendi*), 45, 62, **62**  
*Halichoerus grypus*. See Gray seal  
 Harbor porpoise (*Phocoena*  
*phocoena*), 73, 74, 75, 78, 94, 99,  
 119, **119**, 133  
 Harbor seal (*Phoca vitulina*), 4, 36,  
 37, 38, 39, 41, 42, 43, 63, **63**  
 Harp seal (*Phoca groenlandica*), 38,  
 39, 40, 42, 43, 50, 65, **65**  
 Hawaiian monk seal (*Monachus*  
*schauinslandi*), 39, 40, 41, 43, 45,  
 68, **68**  
 Hawaiian spinner dolphin. See  
 Spinner dolphin  
 Hector's beaked whale (*Mesoplodon*  
*hectori*), 116  
 Hooded seal (*Cystophora cristata*), 2,  
 36, 37, 38, 43, 48, 50, 51, 68, **68**  
 Hubb's beaked whale (*Mesoplodon*  
*carlhubbsi*), 115, **115**  
 Humpback whale (*Megaptera*  
*novaeangliae*), 75, 76, 78, 79,  
 107, **107**, 135, 176, 229, 232, 233  
*Hyperoodon ampullatus*. See  
 Northern bottlenosed whale  
 Killer whale (*Orcinus orca*), 75, 76,  
 121, **121**, 230  
*Kogia breviceps*. See Pygmy sperm  
 whale  
*Kogia simus*. See Dwarf sperm whale  
*Lagenodelphis hosei*. See Fraser's  
 dolphin  
*Lagenorhynchus acutus*. See  
 Atlantic white-sided dolphin  
*Lagenorhynchus albirostris*. See  
 White-beaked dolphin  
*Lagenorhynchus obliquidens*. See  
 Pacific white-sided dolphin  
*Lissodelphis borealis*. See Northern  
 right whale dolphin  
 Long-finned pilot whale (*Globicephala*  
*melas*), **21**, 75, 79, 123, **123**, 133  
*Megaptera novaeangliae*. See  
 Humpback whale  
 Manatee. See West Indian manatee  
 Melon-headed whale (*Peponocephala*  
*electra*), 123, **123**  
*Mesoplodon spp.*, 115  
*Mesoplodon bidens*. See Sowerby's  
 beaked whale  
*Mesoplodon carlhubbsi*. See Hubb's  
 beaked whale  
*Mesoplodon densirostris*. See  
 Blainville's beaked whale  
*Mesoplodon europaeus*. See  
 Gervais' beaked whale  
*Mesoplodon ginkodens*. See Ginko-  
 toothed beaked whale  
*Mesoplodon hectori*. See Hector's  
 beaked whale  
*Mesoplodon mirus*. See True's  
 beaked whale  
*Mesoplodon stejnegeri*. See  
 Stejneger's beaked whale  
 Minke whale (*Balaenoptera*  
*acutorostrata*), 76, 80, 109, **109**,  
 234, 235  
*Mirounga angustirostris*. See  
 Northern elephant seal  
*Monachus schauinslandi*. See  
 Hawaiian monk seal  
*Monodon monoceros*. See Narwhal  
*Monodontidae*, 118  
*Mysticeti*, 71, 104  
 Narwhal (*Monodon monoceros*), 75,  
 77, 119, **119**  
 Northern bottlenosed whale  
 (*Hyperoodon ampullatus*), 114,  
**114**  
 Northern elephant seal (*Mirounga*  
*angustirostris*), 36, 38, 39, 40, 41,  
 43, 69, **69**  
 Northern fur seal (*Callorhinus*

- ursinus*), 36, 38, 39, 40, 41, 43, 61, **61**, 240, 241  
 Northern right whale (*Eubalaena glacialis*), 75, 76, 78, 80, 105, **105**, 176, 231, 237  
 Northern right whale dolphin (*Lissodelphis borealis*), 78, 127, **127**  
*Odobenidae*, 35, 58  
*Odobenus rosmarus*. See Walrus  
*Odontoceti*, 71, 111  
*Orcinus orca*. See Killer whale  
*Otariidae*, 35, 36, 37, **37**, 59  
 Pacific white-sided dolphin (*Lagenorhynchus obliquidentis*), 78, 125, **125**  
 Pantropical spotted dolphin (*Stenella attenuata*), 76, 77, 78, 130, **131**, 133  
*Peponocephala electra*. See Melon-headed whale  
*Phoca fasciata*. See Ribbon seal  
*Phoca groenlandica*. See Harp seal  
*Phoca hispida*. See Ringed seal  
*Phoca largha*. See Spotted seal  
*Phoca spp.*, 63  
*Phoca vitulina*. See Harbor seal  
*Phocidae*, 35, 36, **37**, 63  
*Phocoena phocoena*. See Harbor porpoise  
*Phocoena sinus*. See Vaquita  
*Phocoenidae*, 119  
*Phocoenoides dalli*. See Dall's porpoise  
*Physeter catodon*. See Sperm whale  
*Physeteridae*, 111  
 Pilot whales, 21, 30, 31, 74, 77, 84, 88, 99, 101, 103, 135, 231, 232, 239  
*Pinnipedia*, 35, 58  
*Pseudorca crassidens*. See False killer whale  
 Pygmy killer whale (*Feresa attenuata*), 76, 122, **122**, 133  
 Pygmy sperm whale (*Kogia breviceps*), 72, 73, 112, **112**, 133  
 Ribbon seal (*Phoca fasciata*), 36, 38, 39, 65, **65**  
 Right whale. See Northern right whale  
 Ringed seal (*Phoca hispida*), 37, 38, 39, 40, 41, 43, 64, **64**, 241  
 Risso's dolphin (*Grampus griseus*), 75, 124, **124**, 230  
 Rough-toothed dolphin (*Steno bredanensis*), 76, 128, **128**, 133  
 Sea otter (*Enhydra lutris*), 8, 27, 30, 31, 32, 33, 159-173, **160**, **162**, **181**, 190, **194**, 197, 199, **224**  
 Sei whale (*Balaenoptera borealis*), 76, 109, **109**  
 Short-finned pilot whale (*Globicephala macrorhynchus*), 75, 76, 124, **124**  
 Sowerby's beaked whale (*Mesoplodon bidens*), 117  
 Sperm whale (*Physeter catodon*), 2, 74, 75, 77, 80, 102, 111, **111**, 133, 135, 230, 236  
 Spinner dolphin (*Stenella longirostris*), 74, 75, 76, 78, 129, **129**, 137  
 Spotted dolphin. See Atlantic spotted dolphin; Pantropical spotted dolphin  
 Spotted seal (*Phoca largha*), 39, 64, **64**  
 Stejneger's beaked whale (*Mesoplodon stejnegeri*), 115  
 Steller sea lion (*Eumetopias jubatus*), 38-39, 40, 41, 42, 43, 45, 59, **59**  
*Stenella attenuata*. See Pantropical spotted dolphin  
*Stenella clymene*. See Clymene dolphin  
*Stenella coeruleoalba*. See Striped dolphin  
*Stenella frontalis*. See Atlantic spotted dolphin  
*Stenella longirostris*. See Spinner dolphin  
*Stenella spp.*, 98, 129  
*Steno bredanensis*. See Rough-toothed dolphin  
 Striped dolphin (*Stenella coeruleoalba*), 77, 95, 130, **130**, 133, 135  
*Trichechus manatus*. See West Indian manatee  
 True's beaked whale (*Mesoplodon mirus*), 117



- Tursiops truncatus*. See Bottlenose dolphin
- Vaquita (*Phocoena sinus*), 75, 78, 80, 120
- Walrus (*Odobenus rosmarus*), 8, 35, 36, 37, 38, 39, 40-41, 43, 44, 58, **58**, 199
- West Indian manatee, 8, 27, 30, 33, 145-158, **146**, **149**, **181**, **189**, **193**, 197, 199, 206, 208, **209**, **224**, 233
- White-beaked dolphin (*Lagenorhynchus albirostris*), 77, 126, **126**, 133
- White-sided dolphin. See Atlantic white-sided dolphin; Pacific white-sided dolphin
- Zalophus californianus*. See California sea lion
- Ziphiidae, 113
- Ziphius cavirostris*. See Cuvier's beaked whale



## About the Authors

A native of Massachusetts, Joseph R. Geraci received a Bachelor of Science degree from Suffolk University, a V.M.D. from the University of Pennsylvania, and a Ph.D. from McGill University. His investigations on marine mammal health have spanned arctic and eastern Canada, the United States, Europe and South America. He has received numerous honors, including the New England Aquarium David B. Stone Award for the Environment, and the Comparative Medicine Scholar of the Year award from Tufts University School of Veterinary Medicine. He has served as marine mammal health advisor for the U.S. Department of Agriculture, the U.S. Department of Justice, the National Marine Fisheries Service (NMFS), and the Canadian Department of Fisheries and Oceans. A former member of the Committee of Scientific Advisors to the U.S. Marine Mammal Commission, he is currently a member of the NMFS and the United Nations Environmental Plan task forces on marine mammal mortality. He was the founding editor of the journal *Marine Mammal Science*. Dr. Geraci is a Professor in the Pathology Department, Ontario Veterinary College, University of Guelph.

Valerie J. Lounsbury, born in Maine and raised in Massachusetts, received a Bachelor's degree in biology from New College of the University of South Florida. She was library associate at the University of Guelph before joining the Marine Mammal Laboratory at the Department of Pathology as research associate and technical illustrator. Over the past 14 years Ms. Lounsbury's writings and illustrations have appeared in numerous scientific papers and books on marine mammals.

## **1. Information Update: The Marine Mammal Health and Stranding Response Program**

Marine Mammal stranding networks (for cetaceans and pinnipeds except walruses) in the United States make up one facet of a comprehensive National Marine Fisheries Service (NMFS) program called the Marine Mammal Health and Stranding Response Program (MMHSRP). This program was established in the late 1980s in response to concern about marine mammal strandings along U.S. shorelines. The MMHSRP goals are to: 1) facilitate collection and dissemination of data, 2) assess health trends in marine mammal populations, 3) correlate health with available data on physical, chemical, environmental, and biological parameters, and 4) coordinate effective responses to unusual mortality events (Becker *et al.* 1994).

Volunteer stranding networks, authorized through Letters of Authority from the NMFS regional offices, have been established in all coastal states. NMFS oversees, coordinates, and authorizes stranding response activities through a National Coordinator and five regional coordinators (Wilkinson 1996).

In response to a coastal bottlenose dolphin die-off in 1987-88, NMFS established a Working Group on Unusual Marine Mammal Mortality Events to: 1) establish criteria for determining when an unusual mortality event is underway and 2) provide guidance for responding to such events. The National Contingency Plan (Wilkinson 1996), as well as regional and species-specific plans, have also been developed to help organize effective response efforts and investigations.

### *References*

Becker, P., D. Wilkinson and T.I. Lillestolen. 1994. Marine Mammal Health and Stranding Response Program: Program development plan. U.S. Department of Commerce, NOAA Technical Memorandum NMFS-OPR- 94-2. 35 p.

Wilkinson, D.M. 1996. National contingency plan for response to unusual marine mammal mortality events. U.S. Department of Commerce, NOAA Technical Memorandum NMFS-OPR-9. 118 p.

## **2. Reminder: Communication among stranding networks**

An effective stranding response program requires good communication between neighboring stranding networks and, in the U.S., between neighboring jurisdictions through communication between NMFS (or FWS) regional coordinators. On a broader scale, open lines of communication between neighboring countries can be vital to a successful investigation. Unusual events associated with environmental conditions or infectious disease may result in strandings or illness over a broad geographic range. Long after the investigation has concluded, return of rehabilitated animals to suitable habitat may involve release in foreign waters. Ideally, agreements for cooperation between networks and government agencies, national and international, should be in place beforehand. Staying informed of developments in neighboring regions is especially vital to the recognition and investigation of unusual events.

### **3: Reminder: Unusual marine mammal mortality events**

In the United States, regional stranding network members are required to report observations of unusual numbers of injured or dead marine mammals to the Regional (NMFS) or Species (FWS) stranding coordinator, who then notifies the Office of Protected Species. The Office of Protected Species gathers relevant information and consults the Working Group on Unusual Marine Mammal Mortality Events (WGUMMME). This group advises NMFS or FWS on whether or not the event should be declared unusual and serves in an advisory capacity once an event has been declared. WGUMMME has established the following criteria to help recognize an unusual event (Wilkinson 1996):

1. There is a marked increase in the number or frequency of strandings as compared to prior years. This must be weighed against other knowledge, including percent effort in comparison years. As a practical measure, an increase in strandings over an area or period of time that strains the capacity of the Stranding Network to respond should be cause for concern.
2. Animals are stranding at time of year when strandings are unusual for the area or the species.
3. An increase in strandings is occurring in a very localized area (possibly suggesting a localized problem), is occurring throughout the geographic range of the species/population, or is spreading geographically with time.
4. The species, age or sex composition of the stranded animals is different than that of animals that normally strand in the area at that time of year.
5. Stranded animals exhibit similar or unusual pathologic findings, or the general physical condition (*e.g.*, blubber thickness) of stranded animals is different from what is normally seen.
6. Mortality is accompanied by unusual behavior patterns in individuals in the wild, such as occurrence in unusual habitats or abnormal patterns of swimming and diving.
7. Critically endangered species are stranding. Stranding of three or four right whales, for example, may be cause for great concern, whereas stranding of a similar number of fin whales may not.

#### *Reference*

Wilkinson, D.M. 1996. National contingency plan for response to unusual marine mammal mortality events. U.S. Department of Commerce, NOAA Technical Memorandum NMFS-OPR-9. 118 p.

#### 4. Information Update: Environmental conditions

Unusual oceanographic conditions off the coast of southwestern Africa during much of 1993 and 1994 resulted in reduction or disappearance of fish stocks important as prey for Cape fur seals (*Arctocephalus pusillus pusillus*) in this region (Roux *in* UNEP 1995). By mid 1994, all sex and age groups had suffered record mortality; approximately 120,000 pups had died, and a high rate of abortion was observed among surviving females. Although evidence of exposure to morbillivirus was found, the primary cause of death of pups was chronic starvation (Anselmo *et al.* 1995, Roux *in* UNEP 1995, Geraci *et al.* *in press*).

Unusual numbers of pinniped deaths and strandings were also observed in the Eastern Pacific in 1997/98 in conjunction with the strongest El Niño on record. In late 1997, the numbers of dead or stranded northern fur seals and California sea lions found along the California coast rose dramatically (Marine Mammal Commission 1998). Mortality of northern elephant seal pups at some California rookeries during early 1998 exceeded 85%; pups were washed away by storms, high tides and elevated sea levels (up to 18 inches) and, in one area, were battered by debris from a wrecked pier (*pers. comm.*, Sarah Allen, Senior Scientist, National Park Service, Point Reyes, CA). Abnormal weather patterns persisted through the spring of 1998. Although determining the overall effects on Eastern Pacific pinniped populations will take many months, the 1997/98 El Niño, like the 1983/83 event (Trillmich *et al.* 1991), will likely have the greatest impacts on pup production and first-year survival.

#### References

- Anselmo, S., P. 't Hart, H. Vos, J. Groen and A. D. M. E. Osterhaus. 1995. Mass mortality of Cape fur seals *Arctocephalus pusillus pusillus* in Namibia, 1994. Seal Rehabilitation and Research Centre Publication. Pieterburen, Netherlands. 9 p.
- Geraci, J.R., J. Harwood and V.J. Lounsbury. *In press*. Marine mammal die-offs: causes, investigations, and issues, chapter 19. *In* J.R. Twiss and R.R. Reeves [eds.] Marine Mammals, vol. 1. Smithsonian Institution Press, Washington, D.C.
- Marine Mammal Commission. 1998. Annual report to Congress 1997. Marine Mammal Commission, 4340 East-West Highway, Room 905, Bethesda, Maryland 20814.
- Trillmich, F., K.A. Ono, D.P. Costa, R.L. DeLong, S.D. Feldkamp, J.M. Francis, R.L. Gentry, C.B. Heath, B.J. Le Boeuf, P. Majluf and A.E. York. 1991. The effects of El Niño on pinniped populations in the Eastern Pacific, p. 247-270. *In* F. Trillmich and K.A. Ono [eds.] Pinnipeds and El Niño: responses to environmental stress. Springer-Verlag, Berlin.
- UNEP (United Nations Environment Programme). 1995. Marine mammal/fishery interactions: analysis of cull proposals. UNEP(OCA)/MM.SAC.3/1. United Nations Environment Programme, Nairobi.

## 5. Information Update: Toxic algal blooms

In May to June 1997, half to two-thirds of the largest remaining breeding colony of the highly endangered Mediterranean monk seal (*Monachus monachus*) (estimated at less than 300 animals in 1996) died at Cap Blanc, Mauritania. The cause of this die-off has yet to be established. Investigations have focused on two potential causes: a virus and a biotoxin. Although the seals showed evidence of exposure to morbillivirus (Osterhaus *et al.* 1997), the presence of a local toxic dinoflagellate bloom, the pattern of mortality, clinical signs and lung pathology are more suggestive of biotoxin poisoning (Hernandez *et al.* 1998).

Another die-off involving an endangered pinniped population occurred in January to February 1998. New Zealand sea lion (*Phocarctos hookeri*) pup mortality in the Auckland Islands was at least three times normal, and mortality of adults appeared unusual. There was no evidence to support an infectious agent as the primary cause of this event. Circumstantial evidence, including observations of neurologic impairment in some adults and toxic blooms associated with human illness and the death of fish, sea birds and fur seals in other areas around New Zealand, suggests that biotoxin exposure, perhaps in conjunction with malnutrition subsequent to El Niño-related prey depletion, might have increased the sea lions' susceptibility to opportunistic pathogens (Madie *et al.*, unpublished report).

### References

Hernández, M., I. Robinson, A. Aguilar, L.M. González, L.F. López-Jurado, M.I. Reyer, E. Cacho, J. Franco, V. López-Rodas and E. Costas. 1998. *Nature* 393(6680): 28-29.

Madie, P., P. Duignan, J. Hunter, M. Alley, K. Thompson, J. Meers, S. Fenwick, N. Gibbs, N. Gales and S. Childerhouse. New Zealand sea lion epidemic, January-February 1998. Preliminary report, May 1998. Massey University Cetacean Investigation Centre and Department of Conservation, Private Postal Bag 11222, Palmerston North, New Zealand.

Osterhaus, A., J. Groen, H. Niesters, M. van de Bildt, B. Martina, L. Vedder, J. Vos, H. van Egmond, B.A. Sidi and M.E.O. Barham. 1997. Morbillivirus in monk seal mass mortality. *Nature* 388: 838-839.

## 6. Information Update: Morbilliviruses in pinnipeds

Studies since the 1988 epizootic in European harbor seals have shown that morbillivirus infection (PDV [phocine distemper], CDV [canine distemper]), often without recognized illness, is common in many pinniped populations, including those of most North Atlantic species (Dietz *et al.* 1989; Duignan *et al.* 1993, 1994, 1995, 1997). Serological studies on the Antarctic crabeater seal population (Bengtson *et al.* 1991) now tentatively link the 1955 die-off to morbillivirus (CDV), perhaps transmitted from sled dogs. The 1988 outbreaks of disease in European seals may have been the result of PDV, perhaps introduced by infected migrating harp seals, entering previously unexposed populations that were dense enough to support virus transmission (Heide-Jørgensen *et al.* 1992; Geraci *et al.*, in press). Evidence of exposure to morbillivirus has also been reported in Cape fur seals (*Arctocephalus pusillus pusillus*) (Anselmo *et al.* 1995) and Mediterranean monk seals (*Monachus monachus*) (Osterhaus *et al.* 1997) from the Atlantic coast of Africa. There has been no documented evidence of exposure to morbillivirus in pinnipeds from the west coast of North America.

### References

- Anselmo, S., P. 't Hart, H. Vos, J. Groen and A. D. M. E. Osterhaus. 1995. Mass mortality of Cape fur seals *Arctocephalus pusillus pusillus* in Namibia, 1994. Seal Rehabilitation and Research Centre Publication. Pieterburen, Netherlands. 9 p.
- Bengtson, J.L., P. Boveng, U. Franzén, P. Have, M.P. Heide-Jørgensen and T.J. Härkönen. 1991. Antibodies to canine distemper virus in Antarctic seals. *Marine Mammal Science* 7: 85-87.
- Dietz, R., C.T. Ansen, P. Have and M.P. Heide-Jørgensen. 1989. Clue to seal epizootic? *Nature* 338: 627.
- Duignan, P.J., S. Sadove, J.T. Saliki and J.R. Geraci. 1993. Phocine distemper in harbor seals (*Phoca vitulina*) from Long Island, New York. *Journal of Wildlife Diseases* 29: 465-469.
- Duignan, P. J., J. T. Saliki, D. J. St. Aubin, J. A. House and J. R. Geraci. 1994. Neutralizing antibodies to phocine distemper virus in Atlantic walruses (*Odobenus rosmarus rosmarus*) from Arctic Canada. *Journal of Wildlife Diseases* 30: 90-94.
- Duignan, P.J., J.T. Saliki, D.J. St. Aubin, G. Early, S. Sadove, J.A. House, K. Kovacs and J.R. Geraci. 1995. Epizootiology of morbillivirus infection in North American harbor (*Phoca vitulina*) and gray seals (*Halichoerus grypus*). *Journal of Wildlife Diseases* 31: 491-501.
- Duignan, P.J., O. Nielsen, C. House, K.M. Kovacs, N. Duffy, G. Early, S. Sadove, D.J. St. Aubin, B.K. Rima, and J.R. Geraci. 1997. Epizootiology of morbillivirus infection in harp seals, hooded seals, and ringed seals from the Canadian Arctic and western Atlantic. *Journal of Wildlife Diseases* 33: 7-19.
- Geraci, J.R., J. Harwood and V.J. Lounsbury. *In press*. Marine mammal die-offs: causes, investigations, and issues, chapter 19. *In* J.R. Twiss and R.R. Reeves [eds.] *Marine Mammals*, vol. 1. Smithsonian Institution Press, Washington, D.C.
- Heide-Jørgensen, M.-P., T. Härkönen, R. Dietz and P.M. Thompson. 1992. Retrospective of the 1988 European seal epizootic. *Diseases of Aquatic Organisms* 13: 37-62.
- Osterhaus, A., J. Groen, H. Niesters, M. van de Bildt, B. Martina, L. Vedder, J. Vos, H. van Egmond, B.A. Sidi and M.E.O. Barham. 1997. Morbillivirus in monk seal mass mortality. *Nature* 388: 838-839.

## 7. Information Update: Oil spills

There were few documented reports of pinniped deaths due to oil exposure prior to the *Exxon Valdez* spill in Prince William Sound, Alaska, in 1989. This spill demonstrated the risks of exposure to volatile fractions of oil. These toxic compounds damage the lungs and enter the circulation, where they can attack the liver, nervous system, and blood-forming tissues (St. Aubin and Geraci 1994). An estimated 3,500 to 5,500 sea otters and about 300 harbor seals died. Many seals had degenerative lesions of the brain, probably resulting from inhalation of vapors from fresh oil (Spraker *et al.* 1994).

In February 1997, an oil spill from the tanker *San Jorge* contaminated South American fur seal (*Arctocephalus australis*) and sea lion (*Otaria flavescens*) rookeries on Isla de Lobos, Uruguay. Fur seal pup mortality reached 60-70% on two heavily oiled rookeries, compared with 7-10% in lightly oiled areas. This suggests that oil may have killed about 3,200 pups, or about 10% of the total number of pups born on the island rookery (Levine *et al.* 1997, Ponce de Leon 1997).

### References

Levine, E., A.J. Mearns and T.R. Loughlin. 1997. Emergency assistance in assessing and investigating environmental impacts of the *San Jorge* oil spill. Dept. of Commerce, NOAA/ORCA Hazardous Materials Response and Assessment Division, NOAA/NMFS National Marine Mammal Laboratory, June 1997.

Ponce de León, A. 1997. Evaluation of the damages associated with the oil spill from the ship *San Jorge* on Isla de Lobos, Uruguay: report on activities to achieve recovery of the affected areas and effects on the population of the South American fur seal, *Arctocephalus australis*. Prepared for the Director General, Instituto Nacional de Pesca, Ministerio de Ganadería, Agricultura y Pesca, Constituyente 1497 -CP 11200, Montevideo, Uruguay. 42 p.

St. Aubin, D.J. and J.R. Geraci. 1994. Summary and conclusions, p. 371-376. In T.R. Loughlin [ed.] Marine mammals and the *Exxon Valdez*. Academic Press, Inc., San Diego and London.

Spraker, T.R., L.F. Lowry and K.J. Frost. 1994. Gross necropsy and histopathologic lesions found in harbor seals, p. 281-311. In T.R. Loughlin [ed.] Marine mammals and the *Exxon Valdez*. Academic Press, Inc., San Diego and London.



## 8. Information Update: Morbilliviruses in cetaceans

On the heels of the 1987-88 outbreaks of CDV and PDV in European seals, a third morbillivirus (porpoise morbillivirus) caused the deaths of a few harbor porpoises in waters off Ireland (Kennedy *et al.* 1988). Between 1990 and 1992, the same or a closely related virus (dolphin morbillivirus) killed thousands of striped dolphins in the Mediterranean Sea (*references in text*). The immunosuppressive effect of these viruses led to development of secondary, often overwhelming infections by bacteria, fungi, and other viruses.

Studies since 1988 indicate that morbillivirus infection, often without recognized illness, is common in many cetacean populations (Duignan *et al.* 1995a,b) and was, in fact, present in at least some northwestern Atlantic populations of pilot whales and bottlenose dolphins prior to the European epidemics (Geraci 1989; Duignan *et al.* 1995b, 1996). Retrospective studies indicate that outbreaks have occurred sporadically in southeastern U.S. coastal bottlenose dolphin populations since the early 1980s (Duignan *et al.* 1996) and that this virus may have played an important role in the 1987-88 U.S. central Atlantic coast dolphin die-off (Lipscomb *et al.* 1994, Duignan *et al.* 1995a).

Morbillivirus infection, unassociated with illness, also appears to be common in small cetaceans in the southeastern Pacific (Van Bresseem *et al.* 1998). In populations in which the virus is endemic, infection is presumably widespread but of little consequence, since the animals develop immunity through frequent exposure (Duignan *et al.* 1995a,b). Outbreaks of illness are more likely to follow the introduction of the virus into "naive" (previously unexposed) populations. The role of factors such as malnutrition or exposure to contaminants and biotoxins in disease outbreaks is poorly understood.

### References

- Duignan, P.J., C. House, J.R. Geraci, N. Duffy, B.K. Rima, M.T. Walsh, G. Early, D.J. St. Aubin, S. Sadove, H. Koopman and H. Rinehart. 1995a. Morbillivirus infection in cetaceans of the western Atlantic. *Veterinary Microbiology* 44: 241-249.
- Duignan, P.J., C. House, J.R. Geraci, G. Early, H. Copland, M.T. Walsh, G.D. Bossart, C. Cray, S. Sadove, D.J. St. Aubin and M. Moore. 1995b. Morbillivirus infection in two species of pilot whales (*Globicephala* sp.) from the western Atlantic. *Marine Mammal Science* 11: 150-162.
- Duignan, P.J., C. House, D.K. Odell, R.S. Wells, L.J. Hansen, M.T. Walsh, D.J. St. Aubin, B.K. Rima and J.R. Geraci. 1996. Morbillivirus infection in bottlenose dolphins: evidence for recurrent epizootics in the western Atlantic and Gulf of Mexico. *Marine Mammal Science* 12: 499-515.
- Geraci, J.R. 1989. Clinical investigation of the 1987-88 mass mortality of bottlenose dolphins along the U.S. central and south Atlantic coast. Final Report to the National Marine Fisheries Service, U.S. Navy (Office of Naval Research) and Marine Mammal Commission. 63 p.
- Kennedy, S., J.A. Smyth, P.F. Cush, S.J. McCullough, G.M. Allan and S. McQuaid. 1988. Viral distemper now found in porpoises. *Nature* 336: 21.
- Lipscomb, T.P., F.Y. Schulman, D. Moffett and S. Kennedy. 1994. Morbilliviral disease in Atlantic bottlenose dolphins (*Tursiops truncatus*) from the 1987-1988 epizootic. *Journal of Wildlife Diseases* 30: 567-571.
- Van Bresseem, M.-F., K. Van Waerebeek, M. Fleming and T. Barrett. 1998. Serological evidence of morbillivirus infection in small cetaceans from the Southeast Pacific. *Veterinary Microbiology* 59: 89-98.

## **9. Information Update: North Atlantic right whales**

Human-related mortality is considered the greatest threat to the survival of the North Atlantic right whale population, which is currently estimated at about 300 animals. This population has a low annual recruitment rate--between 1982 through 1995, an average of less than 12 births were documented each year. From 1991 through 1996, 9 of 16 (56%) observed deaths were attributed to human causes: eight to ship strikes and one to entanglement in fishing gear. Taking into account the likelihood that many deaths are unobserved, there is concern that annual mortality in recent years may exceed the recruitment rate (Marine Mammal Commission 1997).

### *Reference*

Marine Mammal Commission. 1997. Annual report to Congress 1996. Marine Mammal Commission, 4340 East-West Highway, Room 945, Bethesda, MD.

## **10. Reminder: Commercial fisheries interactions with marine mammals**

Most commercial fishing vessels do not carry marine mammal observers. Thus evidence of fisheries interactions on animals may provide the first clue that a particular commercial fishery is having an impact on a specific marine mammal population. For this reason, signs of fishery interactions in stranded animals (Kuiken 1996) should be well-documented with photographs and/or videotapes. In the United States, such incidents are reported to the NMFS regional stranding coordinators or FWS species coordinators. Detailed records on the animals should be kept for NMFS (or FWS) review.

### *Reference*

Kuiken, T. [ed.] 1996. Diagnosis of by-catch in cetaceans: proceedings of the second European Cetacean Society workshop on cetacean pathology, Montpellier, France, 2 March 1994. European Cetacean Society Newsletter No. 26 - Special Issue. 43 p.

## **11. Information Update: Tuna fishery/dolphin interactions in the Eastern Tropical Pacific Ocean**

In 1992, the La Jolla Agreement placed voluntary limits on the maximum number of dolphins that could be killed annually in the tuna fishery and lowered the annual yearly maximum to zero after seven years. The signing nations agreed that, if the United States made provisions in the Marine Mammal Protection Act (MMPA) for those countries participating in an international dolphin conservation program, they would enter into a binding international agreement for continued protection of dolphins and the Eastern Tropical Pacific (ETP) ecosystem. The U.S. Congress passed the International Dolphin Conservation Program Act in 1997, amending the MMPA to provide exception to import prohibitions for those nations participating in this program. The Panama Declaration, signed in 1995, established species/stock-specific annual dolphin mortality limits and constituted another important step toward reducing bycatch in commercial fisheries and in sound ecosystem management.

## **12. Information Update: Ingestion of debris**

Some marine mammals ingest various types of discarded items and trash that enter the oceans--mostly from land sources (Faris and Hart 1994). Sperm whales, pygmy sperm whales, rough-toothed dolphins, and Cuvier's beaked whales share a tendency to ingest plastics (Laist 1987). Some of these items may block or perforate the gastrointestinal tract, leading to slow starvation or sudden death. A young pygmy sperm whale, rescued from a New Jersey (U.S.) beach in 1993, for example, was found to have an assortment of trash, mostly plastic, in her stomach (Whitaker *et al.* 1994). Eventually, the material was removed and the whale was fitted with a radio tag and released off the coast of Florida. Although she was tracked successfully for a few days, concerns for her long-term health remained--would she be any more successful in the future in discriminating between plastics and prey?

### *References*

- Faris, F. and K. Hart. 1994. Sea of debris: a summary of the third international conference on marine debris, 8-13 May, Miami, FL. Alaska Fisheries Science Center, NOAA/NMFS, Seattle, WA. 54 pp.
- Laist, D.W. 1987. Overview of the biological effects of lost and discarded plastic debris in the marine environment. *Marine Pollution Bulletin* 18(6B): 319-326.
- Whitaker, B.R., J.R. Geraci and A. Stamper. 1994. The near-fatal ingestion of plastic by a pygmy sperm whale, *Kogia breviceps*. *Proceedings of the International Association for Aquatic Animal Medicine* 25: 108.

### **13. Information Update: Gray whale status**

NMFS has determined that, after years of protection, the Eastern North Pacific stock of the gray whale (*Eschrichtius robustus*) "...has recovered to near its estimated original population size and is neither in danger of extinction through all or a significant portion of its range, nor likely to again become endangered within the foreseeable future..." (Federal Register 1993). The gray whale was officially removed from the Endangered Species List in 1994.

#### *Reference*

Federal Register Volume 58 No. 4, Thursday, January 7, 1993.

### **14. Reminder: Live entanglements**

Working with entangled whales poses risks to the team and to the animal. Well-equipped, trained teams have been designated in areas of the U.S. where the likelihood of these incidents is high. Untrained persons should not attempt to disentangle live animals.

### **15. Information Update: Beluga whales, Alaska**

Beluga whales do mass strand in Cook Inlet, Alaska, due to tides. In 1996, three mass strandings of about 100 beluga whales in total occurred in this area, apparently in association with late runs of Coho salmon in Tournagain Arm.

#### *Reference*

National Marine Fisheries Service, Office of Protected Resources. 1997. Marine Mammal Protection Act of 1972, Annual Report, January 1, 1996 to December 31, 1996. U.S. Dept. Commer., NOAA, NMFS, Office of Protected Resources.

### **16. Information Update: "Chessie"**

In late summer and early autumn 1994, a Florida manatee was sighted in Chesapeake Bay, far north of the usual summer range of this species along the U.S. Atlantic coast. By October, concerned that the manatee would not survive the winter, the U.S. Fish and Wildlife Service requested assistance from Sea World of Florida, the Maryland Department of Natural Resources, and the National Aquarium in Baltimore (NAIB) to capture the manatee (Andrews *et al.* 1995). After a few days spent eating lettuce at NAIB, the 650-kg male was flown back to Florida, fitted with a radio-tracking device, and released into a more appropriate habitat. "Chessie" traveled even farther northward the following summer but returned to Florida without any assistance.

#### *Reference*

Andrews, C., R. Krussman and D. Schofield. 1995. Reaching out: conservation activities at the National Aquarium in Baltimore. *International Zoo Yearbook* 34: 30-36.

## 17. Information Update: Florida manatee population

A February 1996 survey yielded a minimum population of 2,639 manatees. In spite of a record number of deaths in 1996, which included the loss of 283 manatees from Florida's west coast population, the state-wide winter survey in January 1997 yielded a count of 2,229. This included the largest number of manatees (1,329) ever recorded on the west coast (Florida Department of Environmental Protection, *unpublished data*; Marine Mammal Commission 1998).

### Reference

Marine Mammal Commission. 1998. Annual report to Congress 1997. Marine Mammal Commission, 4340 East-West Highway, Room 945, Bethesda, MD.

## 18. Information Update: Manatee mortality and red tides

Red tides in the eastern Gulf of Mexico originate about 10-40 miles offshore from the central west coast of Florida--usually in late summer or early fall, and typically last into January (Anderson and White 1989). Inshore movement is associated with intrusion of oceanic water into coastal areas (Steidinger and Haddad 1981) or other conditions that result in salinities >27 o/oo. Little is known of the conditions that precipitate *Gymnodinium breve* blooms or contribute to their toxicity. This dinoflagellate produces at least nine toxins, which may vary in relative proportion during different stages of growth (Pierce *et al.* 1990, Roszell *et al.* 1990).

Between March 5 and late April 1996, about 150 manatees died along an 80-mile stretch of the southwestern Florida coast in association with a strong red tide. This event occurred in the same area as the biotoxin-related deaths in 1982. Studies indicated that some manatees died rapidly, others after chronically ingesting and inhaling toxic compounds (Bossart *et al.* 1998). In November 1997, 16 manatees died in a less severe red tide in the same area (Marine Mammal Commission 1998). These events demonstrate the serious risk of red tides, particularly those that persist into March and April, to Florida's west coast manatee population.

### References

Anderson, D.M. and A.W. White 1989. Toxic dinoflagellates and marine mammal mortalities. Proceedings of an expert consultation held at the Woods Hole Oceanographic Institution May 8-9, 1989. Woods Hole Oceanographic Institute Technical Report 89-36. 65 p.

Bossart, G.D., D.G. Baden, R.Y. Ewing, B. Roberts and S.D. Wright. 1998. Brevetoxicosis in manatees (*Trichechus manatus latirostris*) from the 1996 epizootic: gross, histologic and immunohistochemical features. *Toxicologic Pathology* 26: 276-282.

Marine Mammal Commission. 1998. Annual report to Congress 1997. Marine Mammal Commission, 4340 East-West Highway, Room 945, Bethesda, MD.

Pierce, R.H., M.S. Henry, L.S. Proffitt and P.A. Hasbrouck. 1990. Red tide toxin (brevetoxin) enrichment in marine aerosol, p. 397-402. *In* E. Graneli, B. Sundstrom, L. Edler and D.M. Anderson [eds.] Toxic marine phytoplankton. Proceedings of the fourth international conference on toxic marine phytoplankton, June 26-30, Lund, Sweden. Elsevier Science Publishing Co., Inc., New York, NY.

Roszell, L.E., L.S. Schulman and D.G. Baden. 1990. Toxin profiles are dependent on growth stages in cultures of *Ptychodiscus brevis*, p. 403-406. *In* E. Graneli, B. Sundstrom, L. Edler and D.M. Anderson [eds.] Toxic marine phytoplankton. Proceedings of the fourth international conference on toxic marine phytoplankton, June 26-30, Lund, Sweden. Elsevier Science Publishing Co., Inc., New York, NY.

Steidinger, K.A. and K.D. Haddad. 1981. Biologic and hydrographic aspects of red tides. *Bioscience* 31: 814-819.

## 19. Information Update: Manatee programs

The Florida Department of Natural Resources is now part of the Florida Department of Environmental Protection (DEP). The agency has state responsibility for manatee protection and conservation and, under permit from FWS, undertakes routine rescue and salvage operations. The Florida DEP's research activities are coordinated through the Florida Marine Research Institute and include population assessment and the manatee carcass salvage program, which is conducted by the Florida DEP's Marine Mammal Pathobiology Laboratory in St. Petersburg. In response to increasing rehabilitation needs, FWS has authorized several additional facilities in Florida to provide critical or long-term care and has also authorized a number of U.S. aquariums outside Florida to house manatees that are unreleasable. The FWS Manatee Recovery Program (Jacksonville, FL) coordinates manatee rescue and rehabilitation programs.

Following the 1996 die-off, the FWS released a contingency plan for unusual events involving manatees (U.S. Fish and Wildlife Service 1997). As the agency responsible for routine operations and for planning state response to unusual events, the Florida DEP drafted a more detailed plan (Geraci and Lounsbury 1997), which includes:

- background information on Florida manatee distribution, patterns and causes of mortality, and federal, state, and other agency involvement in existing programs;
- guidelines for establishing the roles and responsibilities of FWS and state on-site coordinators, and for developing and training response teams;
- criteria and procedures for initiating a response effort, and guidelines for organizing a response to various types of unusual events;
- recommendations for inter-agency communications and public relations;
- protocols for collecting data and tissue samples; and
- information on local and regional resources, agencies, organizations and institutions involved in manatee programs, diagnostic laboratories and expert consultants.

### *References*

Geraci, J.R. and V.J. Lounsbury. 1997. The Florida manatee: contingency plan for health-related events. Final draft, prepared for the Florida Department of Environmental Protection, Division of Marine Resources, Florida Marine Research Institute, St. Petersburg, FL. 101 p. + appendices.

U.S. Fish and Wildlife Service. 1997. Contingency plan for catastrophic manatee rescue and mortality events. Prepared by the Manatee Recovery Program, Jacksonville, Florida, Field Office for Southeast Region USFWS, Atlanta, Georgia. 37 p.

## **20. Information Update: Exxon Valdez sea otter mortality**

Between 3,500 to 5,500 sea otters were estimated to have died from the combined effects of inhalation of volatile fractions, ingested oil, hypothermia and shock (Osborn and Williams 1990, Lipscomb *et al.* 1994). Of the approximately 360 sea otters treated in rescue centers, more than one-third died, despite intensive medical treatment. See Loughlin (1994) for a review of this event.

### *References*

Lipscomb, T.P., R.K. Harris, A.H. Rebar, B.E. Ballachey and R.J. Haebler. 1994. Pathology of sea otters, p. 265-279. *In* T.R. Loughlin [ed.] *Marine mammals and the Exxon Valdez*. Academic Press, Inc., San Diego and London.

Loughlin, T. R. [ed.]. 1994. *Marine mammals and the Exxon Valdez*. Academic Press, Inc., San Diego and London.

Osborn, K. and T.M. Williams. 1990. Postmortem examination of sea otters, p. 134-146. *In* T.M. Williams and R.W. Davis [eds.] *Sea otter rehabilitation program: 1989 Exxon Valdez oil spill*. International Wildlife Research.

## **21. Permits and Forms: Level A data**

A sample form for collecting level A data ("Marine Mammal Stranding Report") is included in the *Forms* folder.

## **22. Information Update: Sample collection and preservation**

- Collect blood for DNA studies in Vacutainer<sup>®</sup> with anticoagulant (*e.g.*, EDTA or citrate, **not** heparin); refrigerate and ship to laboratory. (See Note p. 204.)
- For specialized studies of contaminants, collect bile and 10 ml each whole blood and milk. Freeze at -70°C in dark, cleaned glass containers.
- For biotoxin analysis, collect blood (refrigerate whole blood; freeze serum). Collect samples of brain, lung and upper respiratory tract, spleen, lymph nodes and kidney; preserve in 10% neutral buffered formalin. Collect and freeze urine. (See Note p. 208.)

## **23. Techniques Update: Collection of samples for hematology**

9a: Collect samples for hematology in EDTA tubes. Collect blood samples for clinical chemistry in serum separation or heparin tubes, and in EGTA tubes.

## **24. Information Update: References**

*Additional references for marine mammal necropsy:*

Dierauf, L.A. 1994. Pinniped forensic, necropsy and tissue collection guide. U.S. Dept. Commerce, NOAA Technical Memorandum NMFS-OPR-94-3. 80 p.

Kuiken, T. and M.G. Hartmann [eds.]. 1991. Proceedings of the first European Cetacean Society workshop on cetacean pathology: dissection techniques and tissue sampling, Leiden, The Netherlands, 13-14 September 1991. *European Cetacean Society Newsletter* No. 17 - Special issue. 39 p.

## **25. Reminder: Collecting evidence of human-related trauma**

Human-related injuries vary from gunshot wounds and boat strikes to those caused by nets or propellers. Some injuries are obvious externally; others may require a detailed examination of both soft and bony tissues.

NMFS has developed a human interactions data form designed to help managers and enforcement officers evaluate the nature and importance of these events. This form should be completed in full and accompanied by other types of documentation, such as photographs or videotapes. These records are important for agency management and policy decisions and may serve as vital evidence in cases involving legal action. A human-related injury data form is included in the *Forms* folder.

## **26. Reminder: Internal examination**

At every step of the necropsy, note organ position and color and any noticeable smells.

## **27. Techniques Update: Removal of ears**

If high pressure (blast) is considered a possible cause of death, the bullae should be properly removed and sent for analysis. A protocol for this procedure, included in the *Other Documents* folder, is available in:

Blaylock, R.A., B.G. Mase and C.P. Driscoll [eds.]. 1995. Final report on the workshop to coordinate large whale stranding response in the southeast U.S. U.S. Dept. Commerce, NOAA, National Marine Fisheries Service, Southeast Fisheries Science Center, Charleston Laboratory, Charleston, South Carolina. SEFSC Contributions MIA-96/97-43. 38 p.

## **28. Techniques Update: Collection of blood and bone for DNA studies**

Collect at least 10 ml blood for DNA studies from Code 1 and Code 2 animals (immediately after death). Collect samples in Vacutainer<sup>®</sup> with anticoagulant (e.g., EDTA or citrate, **not** heparin); refrigerate and ship to laboratory using cold packs. If blood has coagulated, collect clotted material and freeze; send frozen (*in* Blaylock *et al.* 1995). Bone samples collected for DNA studies can be air-dried.

### *Reference*

Blaylock, R.A., B.G. Mase and C.P. Driscoll [eds.]. 1995. Final report on the workshop to coordinate large whale stranding response in the southeast U.S. U.S. Dept. Commerce, NOAA, National Marine Fisheries Service, Southeast Fisheries Science Center, Charleston Laboratory, Charleston, South Carolina. SEFSC Contributions MIA-96/97-43. 38 p.

## **29. Permits and Forms: National Biomonitoring Specimen Bank Collection Form**

A National Biomonitoring Specimen Bank collection form is included in the *Forms* folder.



### **30. Techniques Update: Samples for biotoxin analysis**

Collect at least 100-125g samples each of liver and blubber and stomach contents for biotoxin analysis. For manatees, also collect up to 1 liter of the liquid phase by pressing the stomach contents.

Collect at least 10 ml blood from Code 1 and 2 animals (immediately after death) in heparinized syringe or Vacutainer<sup>®</sup>. Separate serum by centrifugation; store frozen\* for shipment. If centrifugation is not possible, refrigerate and ship whole blood using cold packs (*in Blaylock et al.* 1995).

Immunoperoxidase testing allows visible detection of biotoxins in histologically prepared tissues (Bossart *et al.* 1998). Collect and preserve, according to guidelines for samples for histopathology, samples of brain, lung and upper respiratory tract, spleen, lymph nodes and kidney.

Using a syringe and needle, aspirate as much urine from the bladder as possible (minimum 3 ml; freeze\* for shipment).

#### *References*

Bossart, G.D., D.G. Baden, R.Y. Ewing, B. Roberts and S.D. Wright. 1998. Brevetoxicosis in manatees (*Trichechus manatus latirostris*) from the 1996 epizootic: gross, histologic and immunohistochemical features. *Toxicologic Pathology* 26: 276-282.

Blaylock, R.A., B.G. Mase and C.P. Driscoll [eds.]. 1995. Final report on the workshop to coordinate large whale stranding response in the southeast U.S. U.S. Dept. Commerce, NOAA, National Marine Fisheries Service, Southeast Fisheries Science Center, Charleston Laboratory, Charleston, South Carolina. SEFSC Contributions MIA-96/97-43. 38 p.

\*Ideal: freeze at -70°C. Practical: freeze at -20°C.

### **31. Information Update: Quality assurance**

The Analytical Quality Assurance aspect of the Marine Mammal Health and Stranding Response Program provides control or standard reference materials and coordinates inter-laboratory comparisons. The National Institute of Standards and Technology coordinates this effort for NMFS and FWS.

#### *Reference*

Wise, S.A. 1993. Quality assurance of contaminant measurements in marine mammal tissues, p. 2531-2541. *In* O.T. Magoon, W.S. Wilson, H. Converse and L.T. Tobin [eds.] Coastal zone 93: proceedings of the 8th symposium on coastal and ocean management (New Orleans, LA), vol. 3. ASCE, New York, NY.

### **32. Techniques Update: Collection of tissue samples for morbillivirus testing by RT-PCR**

Reverse transcriptase polymerase chain reaction (RT-PCR) is an excellent technique for detection of morbillivirus in tissue samples. The specific strain of morbillivirus can often be determined. While formalin-fixed tissues can be used for morbillivirus RT-PCR, frozen tissues are preferred. The best tissues to submit are lung and lung-associated lymph node. Samples (~2-cm cubes of tissue) should be collected using sterile instruments and placed in sterile containers such as sterile Whirl-pack<sup>®</sup> bags. Only one sample should be placed in each container. The samples should be frozen (preferably at -80°C) and sent on dry ice by overnight mail to the laboratory performing the test. (*Provided by T.P. Lipscomb, Armed Forces Institute of Pathology, Department of Veterinary Pathology, Washington, D.C.*)

### **33. Permits and Forms: Scientific permits**

For information on how to obtain NMFS permit applications for scientific research, visit the National Marine Fisheries Service, Office of Protected Resources website at: [http://www.nmfs.gov/prot\\_res](http://www.nmfs.gov/prot_res).

### **34. Supplementary Protocol: Environmental assessment and sampling**

Stranding events may be influenced or caused by a variety of environmental conditions. The collection of basic data, *e.g.*, general weather and ocean conditions, is always recommended (Level B data). When the cause of the event is unknown, a wide range of environmental factors must be evaluated. These include:

- water temperature;
- air temperatures over the previous 4-6 weeks;
- patterns of winds or currents;
- salinities in affected areas;
- occurrence and distribution of algal blooms (species identification, cell counts and toxin concentrations);
- possible spills or discharges of toxic chemicals; and
- the health of other animal species in the affected area.

All **water and other environmental samples** must be clearly and securely labeled, and sufficient data recorded both on the label and in the field log to provide positive sample identification at a later date (American Public Health Association 1995). This includes:

- the collector's name;
- date, hour and exact GPS location;
- depth, water temperature; and
- any other relevant data (*e.g.*, salinity, dissolved oxygen, tide stage, weather conditions, wind direction and velocity, post-sample handling).

### **Sources of Environmental Data**

In addition to possible relationships to the stranding event, environmental factors also have an impact on the actions and safety of the stranding response team. The team should be aware of current conditions and forecasts before initiating the response and must be informed of predicted changes in environmental conditions. Current information on U.S. and global weather and oceanographic conditions can be found on a number of internet websites. These include the following:

- National Weather Service, Internet Weather Service:  
<http://weather.noaa.gov/weather/curcond.html>

- NOAA National Weather Service Interactive Marine Observations:  
<http://www.nws.fsu.edu/buoy/>
- NOAA National Ocean Service Oceanographic Products and Services Division:  
<http://www.opsd.nos.noaa.gov/>
- Intellicast: <http://www.intellicast.com/weather/>
- The Weather Channel: <http://www.weather.com>

Also, many local TV stations have active World Wide Web sites that offer constantly updated weather reports.

### **Geographic Information Systems Technology (GIS )**

Geographic Information Systems (GIS) develop and manipulate spatial data. The term GIS encompasses a broad range of data and products from simple mapping to complex spatial modeling.

In the past few years, there have been dramatic changes in Geographic Information Systems technology, especially in the areas of simple desktop mapping on personal microcomputers and network-based mapping over the World Wide Web (WWW). The explosion of GIS capabilities has had direct effects in emergency response situations. Now it is common for responders such as firefighters and hazardous spill managers to be in the field with portable computers equipped with a full suite of electronic mapping capabilities.

The Internet also offers a range of geographic data from aerial photos to digital shorelines that can be used directly in stranding events. Aerial photographs, which may be vital for the study of large-scale die-offs, are now available on-line from several federal and state agencies. The National Ocean Service of NOAA and the U.S. Geological Survey of the Department of Interior, for example, both have World Wide Web sites that offer thousands of recent aerial photographs. These sites have map-based search engines for high resolution selection.

Portable computers equipped with simple desktop mapping applications, such as MapInfo and ArcView, can be used on-site for detailed mapping of the stranding location. Most of these applications allow direct electronic input of GPS-based data.

These changes provide new opportunities and tools to manage individual stranding events and, perhaps more importantly, to begin to develop a worldwide spatial database of strandings that can be accessed universally over the Internet.

#### *Reference*

American Public Health Association. 1995. Standard methods for the examination of water and wastewater. 19th edition. American Public Health Association, Washington, D.C.

### 35. Supplementary Protocol: Environmental samples for biotoxin analysis

**Water samples for biotoxin analysis** should be collected:

- from suspected bloom areas and from areas in which distressed or dead animals are found;
- every two days if possible, but at least weekly until cell counts drop to <10,000 cells/liter.

The species of phytoplankton must be identified and the sample analyzed to determine both cell count and toxin concentration (*methods provided by* K. Steidinger, Florida Marine Research Institute, St. Petersburg, FL; and P. Tester, NMFS, Southeast Fisheries Science Center, Beaufort, NC).

1. For **cell counts**, collect surface water samples (from depth of approximately 0.5 m) in clean containers that have been rinsed with seawater from the sample location.
2. Carefully pour some sample water into the storage bottle and rinse. Pour out rinse water and carefully refill without creating bubbles. (Some dinoflagellates, such as *Gymnodinium breve*, are fragile; handle gently to prevent lysing.) When bloom conditions are obvious, 250 ml samples are sufficient; for monitoring purposes, collect 500 ml to 1 liter samples.
3. Wrap bottles in wet paper; place in cooler for transport. Do not place live samples on ice.
4. If samples can be processed within 24 hr of collection, use live samples for counts of *G. breve* or other toxic dinoflagellates.
5. If live material cannot be processed within 24 hr, add Utermohl's solution at the rate of 5 ml per 1 liter of water at the time of sample collection. This will preserve cells for up to 6 months. Store under cool conditions.

Utermohl's solution:	142.9 g KI (potassium iodide)
	71.4 g I <sub>2</sub> (elemental iodine)
	71.4 g NaC <sub>2</sub> H <sub>3</sub> O <sub>2</sub> ·3H <sub>2</sub> O
	(or 43 g NaC <sub>2</sub> H <sub>3</sub> O <sub>2</sub> anhydrous)

Add to a 1 liter volumetric flask. Add approximately 800 ml distilled water and stir overnight. Remove stirring bar and bring to 1 liter. Decant into dark plastic storage bottle. This will keep for 1 year.

Collect **samples for biotoxin concentration** determination as above.

1. Pour measured volume of whole water for which cell count is known through a gravity fiber filter (~0.45 µm pore size). Only gentle vacuum, if any, should be used on the filters (>5 inches [100 mm] Hg vacuum) to protect cells from breaking apart; use gravity filtration if time allows.
2. Freeze and send for analysis.
3. Alternatively, freeze the whole water sample for toxin analysis.

**Samples from other animal species** can provide evidence to support toxins as a cause of marine mammal illness or death.

- Filter-feeding fish and invertebrates can accumulate and retain biotoxins for weeks or months after a bloom has disappeared. Species from areas subject to blooms should be analyzed to provide background biotoxin levels. During an unusual event, collect enough specimens of a species to provide a wet weight of at least 110 g per sample. Place whole or live invertebrates in a clean container without water, seal with tape, and store in double plastic bags. Double bag shucked meat in plastic freezer bags; place label between the bags and freeze immediately (-70°C preferred). Ship the container in a cooler to the laboratory within 24 hr. Do not use ice with whole animals; use dry ice for frozen samples (K. Steidinger, Florida Marine Research Institute, St. Petersburg, FL, *pers. comm.*).
- Collect both dead and healthy fish when possible from areas of fish kills. Double bag individual fish and freeze (-70°C preferred); use dry ice for shipment.

- Contact local wildlife rehabilitation facilities to obtain information on other species of animals (e.g., fish-eating birds) brought in for care; carcasses and/or necropsy reports on such animals could aid investigations.

### **36. Supplementary Protocol: Environmental samples for contaminant analysis**

**Water samples for contaminant analysis** must be collected with care to avoid contamination.

- Collect samples (minimum size 1 liter) of water for organic contaminant analysis in brown glass jars (with Teflon<sup>®</sup>-lined lids) that have been washed with pesticide-residue-grade solvent.
  - Collect (minimum 500 ml) samples of water for heavy metals analysis in acid-washed and rinsed plastic jars.
1. When opening or closing the container and during sampling, allow nothing but the water sample to contact the inside of the jar or lid.
  2. Avoid contamination during sampling; e.g., collect water from the upstream side of the boat or upstream from the sampler's hands; avoid debris.
  3. Immerse jar just below the surface; fill twice and empty; then fill and save contents.
  4. Close lid tightly and pack in cooler with gel freezer packs for transport to laboratory; keep in the dark and do not freeze.

*Note:* Organic analytes may change because of bacterial degradation. Water samples for organic pesticide analyses should be held for a maximum of 7 days before extraction.

**Sediment samples for contaminant analysis** must be collected with the same care.

1. Collect samples in a cleaned (minimum size 250 g) wide-mouth glass jar for organic contaminants and in a plastic jar for metals (prepared as above).
2. Fill jar 3/4 full by scraping jar mouth along top 1 cm of sediment; use jar lid to help secure sample if necessary. Only the sediment sample should contact the inside of the jar or lid.
3. Place tightly closed jars in cooler with gel freezer packs for transport to laboratory. Freeze samples if not shipped within 24 hr.

#### *Reference*

American Public Health Association. 1995. Standard methods for the examination of water and wastewater. 19th edition. American Public Health Association, Washington, D.C..

### 37. Supplementary Protocol: Water samples for microbiological analysis

**Water samples for microbiological analysis** should be collected when the cause of death or illness is unknown or of suspected microbial origin. A variety of pathogenic organisms may be present in water contaminated by wastewater; some of these can multiply in the presence of sufficient nutrients (American Public Health Association 1995).

- Collect samples for microbiological examination in wide-mouth bottles with a capacity of at least 120 ml that have been cleaned and rinsed carefully, rinsed with distilled water, and then sterilized. If necessary, samples may be collected in pre-sterilized plastic bags.
1. Keep bottle closed until it is filled. Do not touch inner surface of cap or neck of bottle.
  2. Obtain samples from beneath the surface and from the upstream side of a boat. Avoid contact with shorelines, bottom sediments, debris, *etc.*
  3. Fill container without rinsing, leaving at least a 2.5-cm air space; replace cap immediately.
  4. Place samples in cooler with gel freezer packs to minimize changes in types and numbers of bacteria.
  5. Transport to laboratory for analysis as soon as possible.

#### Reference

American Public Health Association. 1995. Standard methods for the examination of water and wastewater. 19th edition. American Public Health Association, Washington, D.C..

### 38. Information Update: U.S. laboratories

A list of laboratories with experience in analysis of marine mammal blood and tissues and environmental samples associated with stranding events is included in the *Other Documents* folder.

### 39. Information Update: Transmissible diseases

Several viral and bacterial diseases normally associated with humans or domestic animals are appearing spontaneously or increasing in occurrence in marine mammal populations. Some organisms, such as *Salmonella* sp., have been implicated in disease but also have been isolated from apparently healthy animals (Gilmartin *et al.* 1979, Stroud and Roelke 1980, Banish and Gilmartin 1992, Baker *et al.* 1995). Evidence of infection by bacteria representing an apparently new strain or species of *Brucella* has been found in harbor and gray seals and in several species of odontocetes from around the coasts of England and Wales (Ross *et al.* 1994, Jepson *et al.* 1997) and in at least one species from the U.S. Pacific coast (Ewalt *et al.* 1994). The pathogenic potential of *Brucella* in marine mammals is unknown, but infection in domestic and other terrestrial animals commonly leads to abortion. Mycobacteria of the complex associated with tuberculosis (*M. bovis*, *M. tuberculosis*) are also of concern. An outbreak in a captive colony of New Zealand fur seals (*Arctocephalus forsteri*) and Australian sea lions (*Neophoca cinerea*) (Forshaw and Phelps 1991) was the first indication that this disease, subsequently found in free-ranging pinnipeds from Western Australia (Cousins *et al.* 1993) and Tasmania (Woods *et al.* 1995) may be endemic in certain wild populations. More recently, infection has been reported in southern sea lions (*Otaria flavescens*) and South American fur seals (*Arctocephalus australis*) from Argentina (Bernardelli *et al.* 1996).

#### References

Baker, J.R., A. Hall, L. Hiby, R. Munro, I. Robinson, H.M. Ross and J.F. Watkins. 1995. Isolation of salmonellae from seals from UK waters. *Veterinary Record* 136: 471-472.

Banish, L.D. and W.G. Gilmartin. 1992. Pathological findings in the Hawaiian monk seal. *Journal of Wildlife Diseases* 28: 428-434.

Bernardelli, A., R. Bastida, J. Loureiro, H. Michelis, M.L. Romano, A. Cataldi and E. Costa. 1996. Tuberculosis in sea lions and fur seals from the south-western Atlantic coast. *Revue Scientifique et Technique (International Office of Epizootics)* 15(3): 985-1005.

Cousins, D.V., S.N. Williams, R. Reuter, D. Forshaw, D. Chadwick, D. Coughran, P. Collins and N. Gales. 1993. Tuberculosis in wild seals and characterisation of the seal bacillus. *Australian Veterinary Journal* 70: 92-97.

Ewalt, D.R., J.B. Payeur, B.M. Martin, D.R. Cummins and W.G. Miller. 1994. Characteristics of a *Brucella* species from a bottlenose dolphin (*Tursiops truncatus*). *Journal of Veterinary Diagnostic Investigation* 6: 448-452.

Forshaw, D. and G.R. Phelps. 1991. Tuberculosis in a captive colony of pinnipeds. *Journal of Wildlife Diseases* 27: 288-295.

Gilmartin, W.G., P.M. Vainik and V.M. Neill. 1979. Salmonellae in feral pinnipeds off the southern California coast. *Journal of Wildlife Diseases* 15: 511-514.

Jepson, P.D., S. Brew, A.P. MacMillan, J.R. Baker, J. Barnett, J.K. Kirkwood, T. Kuiken, I.R. Robinson and V.R. Simpson. 1997. Antibodies to *Brucella* in marine mammals around the coast of England and Wales. *Veterinary Record* 141: 513-515.

Ross, H.M., G. Foster, R.J. Reid, K.L. Jahans and A.P. MacMillan. 1994. *Brucella* species infection in sea-mammals. *Veterinary Record* 134: 359.

Stroud, R.K. and M.E. Roelke. 1980. *Salmonella* meningoencephalomyelitis in a northern fur seal (*Callorhinus ursinus*) in a captive colony of pinnipeds. *Journal of Wildlife Diseases* 16: 15-18.

Woods, R., D.V. Cousins, R. Kirkwood and D.L. Obendorf. 1995. Tuberculosis in a wild Australian fur seal (*Arctocephalus pusillus doriferus*) from Tasmania. *Journal of Wildlife Diseases* 31: 83-86.

#### **40. Permits and Forms: Sample Necropsy Form**

An expanded version of this form is available in the *Forms* folder.

#### **Note 41. Information Update: About the Authors**

Joseph Geraci is currently Senior Director of Biological Programs at the National Aquarium in Baltimore, and Research Professor of Pathology and Comparative Medicine at the University of Maryland School of Medicine.

Valerie Lounsbury joined the staff of the National Aquarium in Baltimore in January 1998, as Science Resource Manager, Department of Biological Programs.

**\$25.00**  
**TAMU-SG-93-601**

